

5

UNI Dicht



Die bewährte UNI Dicht – metrisch

*Reliable and tested: UNI Dicht –
metric*



Abb. 1 – UNI Zug Dicht-Kabelverschraubung
Fig. 1 – UNI Dicht Strain relief cable gland

Abb. 2 – UNI Mehrfach mit geteiltem Dichteinsatz für konfektionierte
Kabel
Fig. 2 – UNI Multiple with split sealing insert for pre-assembled cables

Anwendungsorientierte Individualität

Das PFLITSCH-Kabelverschraubungssystem UNI Dicht erfüllt mit seiner Typenvielfalt viele weltweite Anforderungen für Kabel- und Leitungseinführungen. Dabei können EMV- und Ex-Schutz ebenso realisiert werden wie das Einführen von Flach- und Sonderkabeln (z. B. ASI-Bus) oder konfektionierten Kabeln durch geteilte Dichteinsätze. Aber auch Mehrfach-Kabelverschraubungen oder Winkel- und Flanschverschraubungen können verwendet werden. Zudem sind Kombinationen mit Wellrohren und Schutzschläuchen für einen umfassenden mechanischen Kabelschutz möglich.

Individualität in Metall und Kunststoff

Die UNI Dicht-Kabelverschraubung besteht aus dem Verschraubungskörper und dem gewünschten Dichteinsatz. Aus diesen Systemteilen stellt sich der Anwender seine individuelle Verschraubung zusammen – passend zu Einsatzbedingungen, Kabeldurchmessern, Umgebungstemperaturen, Anzahl der Kabel usw. Das ist Individualität in Serienqualität!

UNI Dicht gibt es in den aktuellen Größen M4 bis M120, weiterhin aber auch mit den gängigen Pg-Gewinden und mit internationalen Sondergewinden wie NPT oder Zoll. Die Verschraubungskörper sind verfügbar in den Metallen Messing, Zink, Edelstahl, Aluminium und in den Kunststoffen PVDF und Polycarbonat. Die Dichteinsätze fertigt PFLITSCH aus den hochwertigen Materialien TPE, TPE-V und Silikon. Diese thermoplastischen Elastomere (TPE und TPE-V) und das Silikon sind resistent gegen Chemikalien und sorgen für eine verbesserte Zugentlastung, da sie, z. B. in Kontakt mit Schneidölen, ihr Volumen leicht vergrößern. Darüber hinaus erfüllen UNI Dicht-Kabelverschraubungen serienmäßig hohe Schutzarten bis zu IP 68 (bis 10 bar) bzw. IP 69.

Baukastensystem für alle Anforderungen

Entsprechend den Einsatzanforderungen kann der Anwender seine individuelle Kabelverschraubung zusammenstellen: Ein bestimmtes Anschlussgewinde, Biegeschutz, erhöhte Zugentlastung, Winkelverschraubungen, Abdichtung von Flachkabeln, geteilte Dichteinsätze für konfektionierte Kabel oder die Kombination mit Schläuchen oder Wellrohren sind im System einfach zu realisieren. Sind vorhandene Bohrungen zu klein, hilft UNI Dicht in der erweiterten Bauform. Auch das „Lochen nach Wunsch“ ist auf Anfrage möglich.

Application-oriented individuality

With its multiplicity of types, the PFLITSCH cable gland system UNI Dicht fulfils all the EU requirements for line and cable entries. EMC and explosion protection, insertion of flat and special cables (e.g. ASI-Bus) or pre-assembled cables through divided sealing inserts or several – even different – lines by a multiple gland can be realised as well as by angle and flange glands. Moreover, the combination with corrugated pipes and protective hoses for all-round mechanical cable protection is possible.

Individuality in metal and plastic

The UNI Dicht gland comprises the gland body and the individual sealing insert. Users assemble their individual gland from these system parts in order to meet their conditions of application, the cable diameters, ambient temperatures, number of cables, etc. This is individuality in serial quality!

UNI Dicht currently comes in the sizes M4 to M120, as well as in the well-established Pg threads and with international special threads such as NPT or inch. The system is available in the metals brass, zinc, stainless steel and aluminium, and in the plastics PVDF and polycarbonate. PFLITSCH produces the sealing inserts from high-grade TPE, TPE-V and silicone (LSR). These thermoplastic elastomers (TPE + TPE-V) and the silicone are resistant to many modern chemicals and make for improved strain relief, since volume increases slightly on contact, for example, with cutting oil. Furthermore, UNI Dicht cable glands achieve a high protection rating of up to IP 68 (up to 10 bar) or IP 69 as standard.

Modular system for all requirements

Users can fit their individual cable gland to meet the application requirements: Another connecting thread, bending protection, increased strain relief, angle glands, sealing of flat cables, split sealing inserts for pre-assembled cables or the combination with hoses or corrugated pipes are simple to achieve in the system. Should existing boreholes be a little too small, UNI Dicht will help in the extended configuration. Customised perforations are also available on request.



1



2

Abb. 1 – Kabelverschraubung mit geschlossenem Dichteinsatz
Fig. 1 – Cable gland with closed sealing insert

Abb. 2 – UNI Dicht Biegeschutz Dicht-Kabelverschraubung
Fig. 2 – UNI Dicht Bending protection cable gland

Das PFLITSCH-System UNI Dicht metrisch Systemteile/Seitenübersicht

The PFLITSCH system
UNI Dicht metric
System parts/page reference

DS = Druckschraube
DS = pressure screw

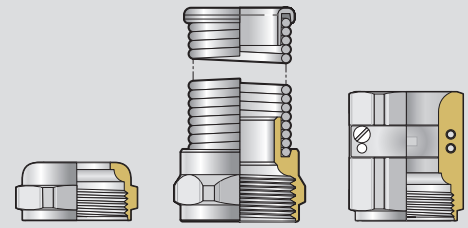

Werkstoff Material	Standard Standard	UNI Flex UNI Flex	UNI Klemm UNI Clamping
Messing Brass	Seite 80-81 Page 80-81	Seite 129 Page 129	Seite 124-125 Page 124-125
Edelstahl Stainless steel	Seite 82-83 Page 82-83		
Polycarbonat Polycarbonate	Seite 84 Page 84		
PVDF PVDF	Seite 85-86 Page 85-86		

E = Dichteinsatz
E = sealing insert



Werkstoff Material	Standard Standard	Erweitert kurz Extended short	Erhöhte Zugentlastung Increased strain relief	EMV HF EMC HF	EMV Konus EMC cone	Mehrfach Form N Multiple form N
TPE TPE	Seite 80-87 Page 80-87	Seite 90-92 Page 90-92	Seite 120-123 Page 120-123	Seite 230-232 Page 230-232	Seite 250-251 Page 250-251	Seite 100-106 Page 100-106
TPE-V TPE-V	Seite 80-87 Page 80-87	Seite 90-92 Page 90-92	Seite 120-123 Page 120-123	Seite 230-232 Page 230-232	Seite 250-251 Page 250-251	Seite 100-106 Page 100-106
Silikon Silicone	Seite 80-87 Page 80-87	Seite 90-92 Page 90-92		Seite 230-232 Page 230-232	Seite 250 Page 250	Seite 107 Page 107

DN = Doppelnippel
DN = double nipple

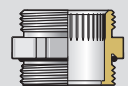

Werkstoff Material	Gewindelänge Standard Standard thread length
Messing Brass	Seite 80-81 Page 80-81
Edelstahl Stainless steel	Seite 82-83 Page 82-83
Polycarbonat Polycarbonate	Seite 84 Page 84
PVDF PVDF	Seite 85-86 Page 85-86
Zink Zinc	

DS & DN = VK (Verschraubungskörper)
DS & DN = VK (gland body)

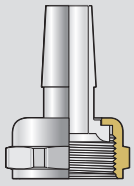

Glatte Schläuche dünnwandig
Plain, thin-walled hoses

Seite 413
Page 413

Auf Anfrage
On request

Auf Anfrage
On request

Seite 414
Page 414

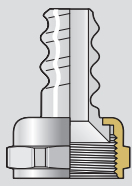

UL-Schlauch
UL hose

Seite 411
Page 411

Auf Anfrage
On request

Auf Anfrage
On request

Seite 412
Page 412

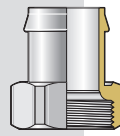

Glatte Schläuche
Plain hose

Seite 415-416
Page 415-416

Auf Anfrage
On request

Seite 417
Page 417

Seite 412
Page 412

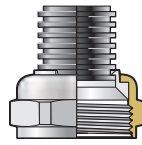

UNI Wellrohr
UNI corrugated conduit

Seite 405
Page 405

Auf Anfrage
On request

Auf Anfrage
On request

Seite 406
Page 406



Mehrfach Form E
Multiple form E

Seite 100-106
Page 100-106

Seite 100-106
Page 100-106

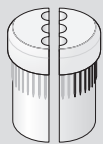

Mehrfach geteilt
Multiple split version

Seite 109-110
Page 109-110

Seite 109-110
Page 109-110



Geschlossen
Closed

Seite 108
Page 108

Seite 108
Page 108

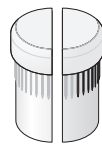

Geschlossen – geteilt
Closed – split version

Seite 109-110
Page 109-110

Seite 109-110
Page 109-110



Flachkabel
Flat cable

Seite 113-117
Page 113-117

Seite 113-117
Page 113-117



ASi-Bus-Kabel
ASi-Bus cable

Seite 111-112
Page 111-112

Seite 111-112
Page 111-112



Biegeschutz
Bending protection

Auf Anfrage
On request

Seite 126-128
Page 126-128



Biegeschutz/erhöhte Zugentlastung
Bending protection incl. strain relief

Auf Anfrage
On request

Seite 130-132
Page 130-132

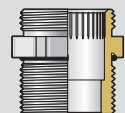

Gewindelänge lang
Long thread length

Seite 80-81,87
Page 80-81,87

Seite 82-83
Page 82-83

Seite 85
Page 85

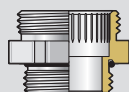

Form E erweitert
Form E extended

Seite 90
Page 90

Seite 91
Page 91

Seite 92
Page 92

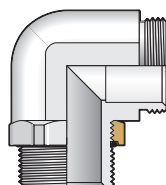

Winkel
Angle

Seite 365,368
Page 365,368

Seite 365,368
Page 365,368

Seite 362-364,367
Page 362-364,367

Seite 362-364,367
Page 362-364,367

**Das PFLITSCH-System
UNI Dicht metrisch
Aufbau der Artikelnummern**

*The PFLITSCH system
UNI Dicht metric
Article number structure*

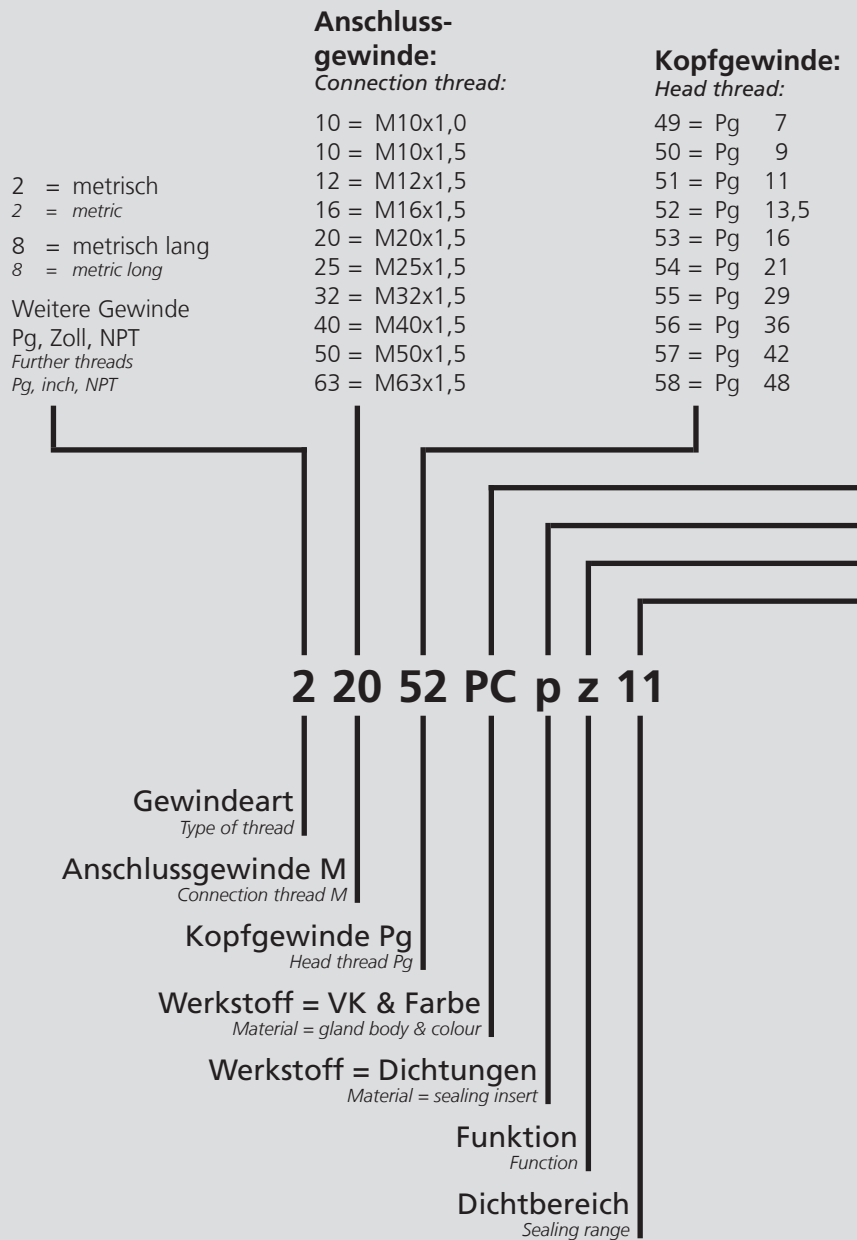

Funktion:
Function:

- = Standard-Dichteinsatz
standard sealing insert
- z = Zugentlastung
strain relief
- e = Entstörung
interference suppression
- ez = Entstörung & Zugentlastung
interference suppression & strain relief
- L = Biegeschutz
bending protection
- Lz = Biegeschutz & Zugentlastung
bending protection & strain relief
- m = Mehrfach
multiple
- mK = Multifunktion (Stecker)
multifunction (connector)
- s = Schlauch
hose

f...g = flach gerundet
flat rounded

f...v = flach oval
flat oval

f...e = flach eckig
flat angular

F = Flex
flex

W = Wellrohr
corrugated

UL = Schlauchverschraubung
UL hose

g = geschlossen
closed

B = Brandschutz
fire protection

Dichtbereich:
Sealing range:

- 7 = 6,5 - 4,0
- 8 = 8,0 - 5,0
- 9 = 9,5 - 6,5
- 11 = 10,5 - 7,0
- 13 = 13,0 - 9,0
- 16 = 15,5 - 11,5
- 18 = 18,0 - 14,0
- 20 = 20,5 - 17,0
- 25 = 25,0 - 20,0
- 28 = 28,0 - 24,0
- 32 = 32,0 - 27,0
- 34 = 34,0 - 29,0
- 36 = 36,0 - 32,0
- 40 = 40,0 - 36,0
- 44 = 44,0 - 39,0

Werkstoffe
Verschraubungskörper:
Materials gland body:

- d = Messing vernickelt
brass, nickel plated
- st = VA (1.4305)
AISI 303
- PC = Polycarbonat
polycarbonate
- PCn = Polycarbonat Farbe schwarz
polycarbonate Colour black
- PCw = Polycarbonat Winkel
polycarbonate Angle
- y = PVDF Farbe transparent
Colour transparent
- ya = PVDF Farbe blau
Colour blue
- yn = PVDF Farbe schwarz
Colour black
- VW = Zink Winkel
zinc Angle

**Werkstoffe
Dichtungen:**
**Materials
sealing inserts:**

- = TPE
- p = TPE-V
- H = Silikon
silicone

Das PFLITSCH-System UNI Dicht – Komponenten

The PFLITSCH system
UNI Dicht –
components

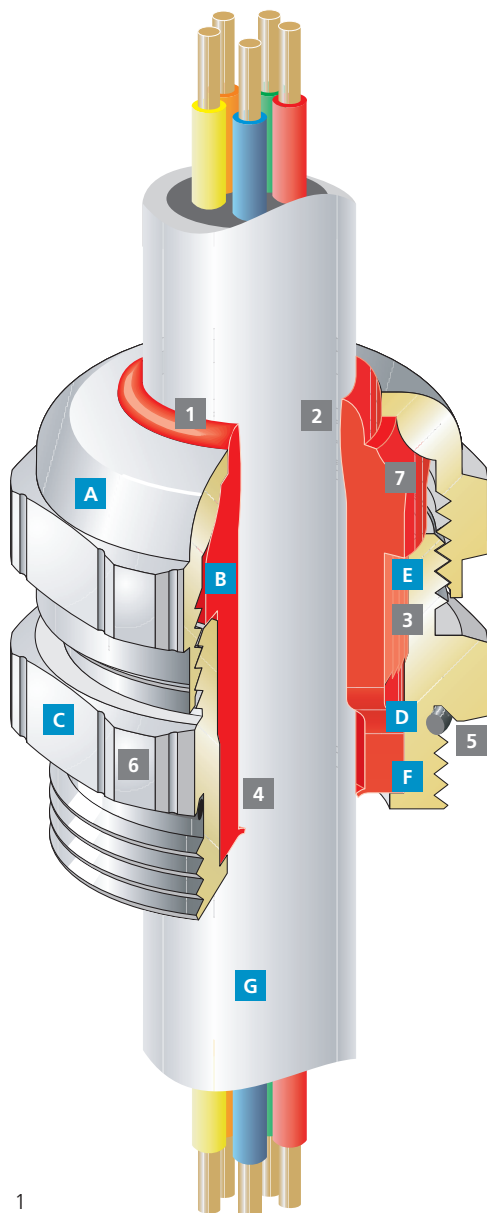

1

Abb. 1 – Querschnitt einer UNI Dicht-Kabelverschraubung
Fig. 1 – Cross-section of a UNI Dicht cable gland

Komponenten:

Components:

- A** Druckschraube (DS)
Pressure screw (DS)
- Messing, galvanisch vernickelt
- Brass, galvanic nickel-plated
- Edelstahl (1.4305)
- Stainless steel (AISI 303)
- Edelstahl (1.4571)
- Stainless steel (AISI 316 Ti)
- Polycarbonat (PC)
- Polycarbonate (PC)
- PVDF
- PVDF
- B** Dichteinsatz (E)
Sealing insert (E)
- TPE
- TPE
- TPE-V
- TPE-V
- Silikon
- Silicone
- C** Doppelnippel (DN)
Double nipple (DN)
- Messing, galvanisch vernickelt
- Brass, galvanic nickel-plated
- Edelstahl (1.4305)
- Stainless steel (AISI 303)
- Edelstahl (1.4571)
- Stainless steel (AISI 316 Ti)
- Polycarbonat (PC)
- Polycarbonate (PC)
- PVDF
- PVDF
- D** O-Ring
O-ring
Bei metallischen DN
With metallic DN
- Kautschuk (HNBR)
- Rubber (HNBR)
- Silikon
- Silicone
- E** Kopfgewinde
Head thread
- Standard
- Standard
- Erweitert
- Extended
- Reduziert (auf Anfrage)
- Reduced (on request)
- F** Anschlussgewinde
Connection thread
- Metrisch
- Metric
- Pg
- Pg
- NPT
- NPT
- Zoll
- Inch
- Standard/Lang
- Standard/long
- G** Kabel
Cable

Vorteile:

Advantages:

- 1** - Kein stehendes Wasser
- No standing water
- IP 68 bis 10 bar zum Kabel und zur Druckschraube
- IP 68 up to 10 bar to the cable and pressure screw
- 2** - Radialsymmetrisch weiche Kabelpressung
- Radially symmetrical soft cable pressing
- Großflächige Zugentlastung
- Large-area strain relief
- Keine Beschädigung des Kabels
- No damage to the cable
- 3** - Verdreherschutz durch Rändelung am Doppelnippel (DN) und Dichteinsatz (E)
- Protection against distortion by knurling on the double nipple (DN) and sealing insert (E)
- Kein Verdrehen des Kabels bei Montage/Demontage
- No cable twisting in assembly/disassembly
- 4** - IP 54 durch Membrane am Dichteinsatz ohne Anziehen der Druckschraube (DS)
- IP 54 through diaphragms on the sealing insert without the pressure screw (DS) tightened up
- 5** - Nutgeführter O-Ring sichert Abdichtung zur Gehäusewandung
- Groove-guided o-ring secures sealing to the housing wall
- 6** Kennzeichnung unserer Qualität: zwölf Riefen – das PFLITSCH-Warenzeichen
- Marking of our quality: Twelve grooves – the PFLITSCH trademark
- 7** - Farbcodierung der TPE-Dichteinsätze (E), dadurch direkte Zuordnung und Überprüfung der Dichteinsätze zu den verwendeten Kabeldurchmessern
- Colour coding of the TPE sealing inserts (E), thereby enabling direct assignment and checking of the sealing inserts for the cable diameters used



UNI-Farbcode (FC) für TPE-Dichteinsätze

UNI colour code (CC) for TPE sealing inserts

Farbcode FC Colour code CC	Dichtbereich Sealing range max./min. Ø	Anschlussgewinde Connection thread
Gelb Yellow	(ge) 6,5 – 4,0	M10, M12, M16, M20, M25 Pg 7, Pg 9, Pg 11, Pg 13,5, Pg 16
Grau Grey	(gu) 8,0 – 5,0	M12, M16, M20, M25 Pg 9, Pg 11, Pg 13,5, Pg 16
Schwarz Black	(sw) 9,5 – 6,5	M12, M16, M20, M25 Pg 9, Pg 11, Pg 13,5, Pg 16
Grün Green	(gr) 10,5 – 7,0	M16, M20, M25, M32 Pg 11, Pg 13,5, Pg 16, Pg 21
Rot Red	(rt) 13,0 – 9,0	M16, M20, M25, M32 Pg 9, Pg 13,5, Pg 16, Pg 21
Weiß White	(ws) 15,5 – 11,5	M20, M25, M32, M40 Pg 16, Pg 21, Pg 29
Blau Blue	(bl) 18,0 – 14,0	M20, M25, M32, M40 Pg 16, Pg 21, Pg 29
Braun Brown	(br) 20,5 – 17,0	M20, M25, M32, M40 Pg 13,5, Pg 16, Pg 21, Pg 29
Orange Orange	(or) 25,0 – 20,0	M32, M40 Pg 16, Pg 21, Pg 29
Hellgelb Light yellow	(hg) 28,0 – 24,0	M32, M40 Pg 16, Pg 21, Pg 29
Anthrazit Anthracite	(an) 32,0 – 27,0	M32, M40, M50 Pg 21, Pg 29, Pg 36
Hellblau Light blue	(hb) 34,0 – 29,0	M32, M40, M50 Pg 21, Pg 29, Pg 36
Rosa Pink	(rs) 36,0 – 32,0	M32, M40, M50 Pg 21, Pg 29, Pg 36
Weiß White	(ws) 40,0 – 36,0	M50 Pg 36, Pg 42
Weiß White	(ws) 44,0 – 39,0	M63 Pg 48

Ab Größe M63 standardmäßig weiße Dichteinsätze
From size M63 standard white sealing inserts

UNI Dicht-Kabelverschraubung

UNI Dicht cable gland



Abb. 1
Fig. 1



Abb. 2
Fig. 2

Messing vernickelt
Metrisches Anschlussgewinde EN 60423
Mit O-Ring HNBR
Schutzart IP 68 bis 10 bar, Type 4X
Zugentlastung bis Klasse A, EN 62444

Brass, nickel-plated
Metric connection thread EN 60423
With o-ring HNBR
Type of protection IP 68 up to 10 bar, Type 4X
Strain relief up to class A, EN 62444

i Gewinde-Varianten: Standard-Maß D = 15 mm Länge
Thread variants: Standard size D = 15 mm length
= Art.-Nr. 22052...
= Art.-Nr. 82052...
= art. no. 22052...
= art. no. 82052...

Werkstoff Verschraubungskörper Material gland body	Ausführung/Farbe Version/colour	Werkstoff Dichteinsatz Material sealing insert	Farbe Colour	Bestellschlüssel Art. no. supplement	Temperaturbereich min./max. Temperature range (min./max.)
Messing Brass	Vernickelt Nickel-plated	TPE	s. FC s. CC		-40 °C / +130 °C
Messing Brass	Vernickelt Nickel-plated	TPE-V	Natur Natural	p	-40 °C / +135 °C
Messing Brass	Vernickelt Nickel-plated	Silikon HT Silicone HT	Schwarz Black	H	-55 °C / +200 °C



Abb. 3
Fig. 3



Abb. 4 – Ausführung lang/D = 15 mm
Fig. 4 – Longer execution/D = 15 mm

Anschlussgewinde/-länge Connection thread/length		Art.-Nr. Art. no.	Dichtbereich Sealing range	Bauhöhe Mounting height	Schlüsselweite Spanner width	
Ausführung bitte ergänzen Please complete product details						
A	D mm	TPE = p TPE-V = H Silikon HT/Silicone HT = H	max./min. ø mm	C mm	SW₁ x E₁/SW₂ x E₂ mm	
M4x0,7	2,7	204d	1,6 *	8,8	6x6,8	50
M6x0,75	4,5	206d	3 *	14,0	8x9	50
M8x1,0	6,5	208210d	4,5	15,5	11x12,2	50
M10x1,0	5,0	21049d	7/1mm	19,5	14x15,5	50
M10x1,5	5,0	21049d	7/1,5mm *	19,5	14x15,5	50
M12x1,5	5,0	21249d	7 *	19,0	14x15,5	50
M16x1,5	6,0	21650d	7	20,0	18x20/17x18,9	50
		21650d	8	20,0	18x20/17x18,9	50
		21650d	9	20,0	18x20/17x18,9	50
M20x1,5	6,5	22052d	7	21,0	22x24,4	50
		22052d	8	21,0	22x24,4	50
		22052d	9	21,0	22x24,4	50
		22052d	11	21,0	22x24,4	50
		22052d	13	21,0	22x24,4	50
M25x1,5	7,5	22553d	7	21,0	28x31,2/24x26,7	50
		22553d	8	21,0	28x31,2/24x26,7	50
		22553d	9	21,0	28x31,2/24x26,7	50
		22553d	11	21,0	28x31,2/24x26,7	50
		22553d	13	21,0	28x31,2/24x26,7	50
		22553d	16	21,0	28x31,2/24x26,7	50
M32x1,5	8,0	23254d	11	26,0	35x38,5/30x33,5	25
		23254d	13	26,0	35x38,5/30x33,5	25
		23254d	16	26,0	35x38,5/30x33,5	25
		23254d	18	26,0	35x38,5/30x33,5	25
		23254d	20	26,0	35x38,5/30x33,5	25
M40x1,5	8,0	24055d	16	29,0	43x47,3/40x43,5	10
		24055d	18	29,0	43x47,3/40x43,5	10
		24055d	20	29,0	43x47,3/40x43,5	10
		24055d	25	29,0	43x47,3/40x43,5	10
		24055d	28	29,0	43x47,3/40x43,5	10

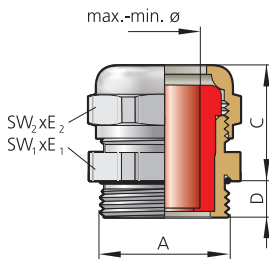
* Dichteinsatz kurz = Art.-Nr.: Ek...
* Sealing insert short = art. no.: Ek...

Fortsetzung auf der nächsten Seite
Continued on next page

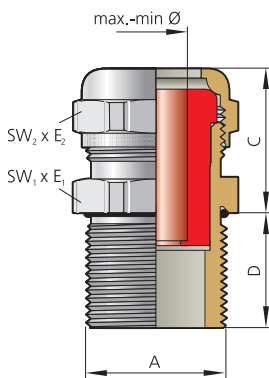
UNI Dicht-Kabelverschraubung

UNI Dicht cable gland

Fortsetzung von vorheriger Seite
Continued from previous page

Anschlussgewinde/-länge Connection thread/length		Art.-Nr. Art. no.	Dichtbereich Sealing range	Bauhöhe Mounting height	Schlüsselweite Spanner width		
Ausführung bitte ergänzen Please complete product details							
A	D mm	TPE =	max./min. ø mm	C mm	SW ₁ x E ₁ /SW ₂ x E ₂ mm		
		TPE-V = p					
		Silikon HT/Silicone HT = H					
M50x1,5	10,0	25056d	32	32,0–27,0	30,0	54x58/50x54	5
		25056d	34	34,0–29,0	30,0	54x58/50x54	5
		25056d	36	36,0–32,0	30,0	54x58/50x54	5
M63x1,5	10,0	26358d	44 *	44,0–39,0	30,0	68x74/64x69	5
M63x1,5	16,0	26375	45 *	45,0–40,0	55,0	81x87	1
		26375	51 *	51,0–45,0	55,0	81x87	1
		26375	56 *	56,0–51,0	55,0	81x87	1
M72x2	16,0	27275	45 *	45,0–40,0	56,0	81x87	1
		27275	51 *	51,0–45,0	56,0	81x87	1
		27275	56 *	56,0–51,0	56,0	81x87	1
M75x1,5	15,0	275212d	47 *	47,0–42,0	46,0	81x87	1
		275212d	52 *	52,0–45,0	46,0	81x87	1
		275212d	55 *	55,0–51,0	46,0	81x87	1
		275212d	58 *	58,0–54,0	46,0	81x87	1
M80x2,0	15,0	280300d	57 *	57,0–50,0	61,0	95x102	1
		280300d	64 *	64,0–58,0	61,0	95x102	1
		280300d	70 *	70,0–63,0	61,0	95x102	1
M90x2	20,0	290400d	76 *	76,0–69,0	62,0	120x128	1
		290400d	85 *	85,0–70,0	62,0	120x128	1
M100x2,0	20,0	2100400d	76 *	76,0–69,0	63,0	120x128	1
		2100400d	85 *	85,0–70,0	63,0	120x128	1
		2100400d	90 *	90,0–75,0	63,0	120x128	1
M120x2,0	30,0	2120500d	100 *	100,0 – 90,0	70,0	145x155	1
		2120500d	110 *	110,0 – 100,0	70,0	145x155	1

* Dichteinsatz aus Silikon HT nicht lieferbar
* Sealing insert silicone HT not available

i Passende Gegenmuttern ab Seite 442
Corresponding locknuts see from page 442

11400 | ITT00400

UNI Dicht-Kabelverschraubung

UNI Dicht cable gland



Abb. 1
Fig. 1



Abb. 2
Fig. 2

Edelstahl 1.4305
Metrisches Anschlussgewinde EN 60423
Mit O-Ring Silikon
Schutzart IP 68 bis 10 bar, Type 4X
Zugentlastung bis Klasse A, EN 62444

Stainless steel AISI 303
Metric connection thread EN 60423
With o-ring silicone
Type of protection IP 68 up to 10 bar, Type 4X
Strain relief up to class A, EN 62444

i Gewinde-Varianten: Standard-Maß D
15 mm Länge
Thread variants: Standard size D
15 mm length
= Art.-Nr. 22052...
= Art.-Nr. 82052...
= art. no. 22052...
= art. no. 82052...

Werkstoff Verschraubungskörper Material gland body	Ausführung/Farbe Version/colour	Werkstoff Dichteinsatz Material sealing insert	Farbe Colour	Bestellschlüssel Art. no. supplement	Temperaturbereich min./max. Temperature range (min./max.)
VA 1.4305 AISI 303	Blank	TPE	s. FC s. CC		-40 °C / +130 °C
VA 1.4305 AISI 303	Blank	TPE-V	Natur Natural	p	-40 °C / +135 °C
VA 1.4305 AISI 303	Blank	Silikon HT Silicone HT	Schwarz Black	H	-55 °C / +200 °C



Abb. 3
Fig. 3



Abb. 4
Fig. 4

Anschlussgewinde/-länge Connection thread/length	Art.-Nr. Art. no.	Dichtbereich Sealing range	Bauhöhe Mounting height	Schlüsselweite Spanner width			
Ausführung bitte ergänzen Please complete product details							
A	D mm	TPE = TPE-V = p Silikon HT/Silicone HT = H	max./min. Ø mm	C mm			
				SW₁ x E₁/SW₂ x E₂ mm			
M10x1,0	5,0	21049st	7/1mm *	6,5 – 4,0	19,0	14x15,5	50
M10x1,5	5,0	21049st	7/1,5mm *	6,5 – 4,0	19,0	14x15,5	50
M12x1,5	5,0	21249st	7 *	6,5 – 4,0	19,0	14x15,5	50
M16x1,5	6,0	21650st	7	6,5 – 4,0	20,0	19x21/17x18,9	50
		21650st	8	8,0 – 5,0	20,0	19x21/17x18,9	50
		21650st	9	9,5 – 6,5	20,0	19x21/17x18,9	50
M20x1,5	6,5	22051st	7	6,5 – 4,0	20,0	22x24,4	50
		22051st	8	8,0 – 5,0	20,0	22x24,4	50
		22051st	9	9,5 – 6,5	20,0	22x24,4	50
		22051st	11	10,5 – 7,0	20,0	22x24,4	50
		22052st	7	6,5 – 4,0	21,0	22x24,4	50
		22052st	8	8,0 – 5,0	21,0	22x24,4	50
		22052st	9	9,5 – 6,5	21,0	22x24,4	50
		22052st	11	10,5 – 7,0	21,0	22x24,4	50
		22052st	13	13,0 – 9,0	21,0	22x24,4	50
M25x1,5	7,5	22553st	7	6,5 – 4,0	21,0	27x29,5/24x26,7	50
		22553st	8	8,0 – 5,0	21,0	27x29,5/24x26,7	50
		22553st	9	9,5 – 6,5	21,0	27x29,5/24x26,7	50
		22553st	11	10,5 – 7,0	21,0	27x29,5/24x26,7	50
		22553st	13	13,0 – 9,0	21,0	27x29,5/24x26,7	50
		22553st	16	15,5 – 11,5	21,0	27x29,5/24x26,7	50
M32x1,5	8,0	23254st	11	10,5 – 7,0	26,0	36x39,5/30x33,5	25
		23254st	13	13,0 – 9,0	26,0	36x39,5/30x33,5	25
		23254st	16	15,5 – 11,5	26,0	36x39,5/30x33,5	25
		23254st	18	18,0 – 14,0	26,0	36x39,5/30x33,5	25
		23254st	20	20,5 – 17,0	26,0	36x39,5/30x33,5	25
M40x1,5	8,0	24055st	16	15,5 – 11,5	28,0	46x50/41x44,5	10
		24055st	18	18,0 – 14,0	28,0	46x50/41x44,5	10
		24055st	20	20,5 – 17,0	28,0	46x50/41x44,5	10
		24055st	25	25,0 – 20,0	28,0	46x50/41x44,5	10
		24055st	28	28,0 – 24,0	28,0	46x50/41x44,5	10
M50x1,5	10,0	25056st	32	32,0 – 27,0	29,0	55x60,5/50x54	5
		25056st	34	34,0 – 29,0	29,0	55x60,5/50x54	5
		25056st	36	36,0 – 32,0	29,0	55x60,5/50x54	5
		25057st	40 * **	40,0 – 36,0	32,0	60x65	5
M63x1,5	10,0	26358st	44 **	44,0 – 39,0	30,0	68x74/65x70	5

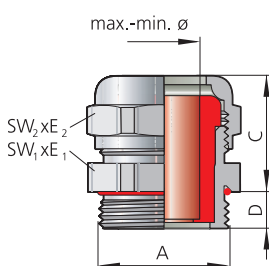
* Dichteinsatz kurz = Art.-Nr.: Ek... ** Dichteinsatz aus Silikon HT nicht lieferbar
* Sealing insert short = art. no.: Ek... ** Sealing insert silicone HT not available

i Passende Gegenmuttern ab Seite 442
Corresponding locknuts see from page 442

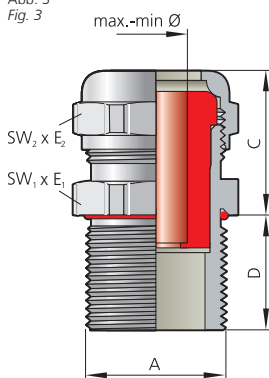
UNI Dicht-Kabelverschraubung

UNI Dicht cable gland



Abb. 1
Fig. 1



Abb. 2
Fig. 2

Edelstahl 1.4571
Metrisches Anschlussgewinde EN 60423
Mit O-Ring Silikon
Schutzart IP 68 bis 10 bar, Type 4X
Zugentlastung bis Klasse A, EN 62444

Stainless steel AISI 316Ti
Metric connection thread EN 60423
With o-ring silicone
Type of protection IP 68 up to 10 bar, Type 4X

Gewinde-Varianten: Standard-Maß D = Art.-Nr. 22052...
Thread variants: 15 mm Länge = Art.-Nr. 82052...
Standard size D = art. no. 22052...
15 mm length = art. no. 82052...

Werkstoff Verschraubungskörper Material gland body	Ausführung/Farbe Version/colour	Werkstoff Dichteinsatz Material sealing insert	Farbe Colour	Bestellschlüssel Art. no. supplement	Temperaturbereich min./max. Temperature range (min./max.)
VA 1.4571 AISI 316Ti	Blank	TPE	s. FC s. CC		-40 °C / +130 °C
VA 1.4571 AISI 316Ti	Blank	TPE-V	Natur Natural	p	-40 °C / +135 °C
VA 1.4571 AISI 316Ti	Blank	Silikon HT Silicone HT	Schwarz Black	H	-55 °C / +200 °C



Abb. 3
Fig. 3



Abb. 4
Fig. 4

Anschlussgewinde/-länge Connection thread/length		Art.-Nr. Art. no.	Dichtbereich Sealing range	Bauhöhe Mounting height	Schlüsselweite Spanner width	
Ausführung bitte ergänzen Please complete product details						
A	D mm	TPE =	max./min. Ø mm	C mm	SW ₁ x E ₁ / SW ₂ x E ₂ mm	
		TPE-V = p				
		Silikon HT/Silicone HT = H				
M12x1,5	5,0	21249st	7 V4A *	6,5– 4,0	19,0	14x15,5 50
M16x1,5	6,0	21650st	7 V4A	6,5– 4,0	20,0	19x21/17x18,9 50
		21650st	8 V4A	8,0– 5,0	20,0	19x21/17x18,9 50
		21650st	9 V4A	9,5– 6,5	20,0	19x21/17x18,9 50
		21650st	9 V4A	9,5– 6,5	20,0	19x21/17x18,9 50
M20x1,5	6,5	22051st	7 V4A	6,5– 4,0	20,0	22x24,4 50
		22051st	8 V4A	8,0– 5,0	20,0	22x24,4 50
		22051st	9 V4A	9,5– 6,5	20,0	22x24,4 50
		22051st	11V4A	10,5– 7,0	20,0	22x24,4 50
		22052st	7 V4A	6,5– 4,0	21,0	22x24,4 50
		22052st	8 V4A	8,0– 5,0	21,0	22x24,4 50
		22052st	9 V4A	9,5– 6,5	21,0	22x24,4 50
		22052st	11V4A	10,5– 7,0	21,0	22x24,4 50
		22052st	13V4A	13,0– 9,0	21,0	22x24,4 50
		22052st	13V4A	13,0– 9,0	21,0	22x24,4 50
M25x1,5	7,5	22553st	7 V4A	6,5– 4,0	21,0	27x29,5/24x26,7 50
		22553st	8 V4A	8,0– 5,0	21,0	27x29,5/24x26,7 50
		22553st	9 V4A	9,5– 6,5	21,0	27x29,5/24x26,7 50
		22553st	11V4A	10,5– 7,0	21,0	27x29,5/24x26,7 50
		22553st	13V4A	13,0– 9,0	21,0	27x29,5/24x26,7 50
		22553st	16V4A	15,5– 11,5	21,0	27x29,5/24x26,7 50
M32x1,5	8,0	23254st	11V4A	10,5– 7,0	26,0	36x39,5/30x33,5 25
		23254st	13V4A	13,0– 9,0	26,0	36x39,5/30x33,5 25
		23254st	16V4A	15,5– 11,5	26,0	36x39,5/30x33,5 25
		23254st	18V4A	18,0– 14,0	26,0	36x39,5/30x33,5 25
		23254st	20V4A	20,5– 17,0	26,0	36x39,5/30x33,5 25
		23254st	20V4A	20,5– 17,0	26,0	36x39,5/30x33,5 25
M40x1,5	8,0	24055st	16V4A	15,5– 11,5	28,0	46x50/41x44,5 10
		24055st	18V4A	18,0– 14,0	28,0	46x50/41x44,5 10
		24055st	20V4A	20,5– 17,0	28,0	46x50/41x44,5 10
		24055st	25V4A	25,0– 20,0	28,0	46x50/41x44,5 10
		24055st	28V4A	28,0– 24,0	28,0	46x50/41x44,5 10
		24055st	28V4A	28,0– 24,0	28,0	46x50/41x44,5 10
M50x1,5	10,0	25056st	32V4A	32,0– 27,0	29,0	55x60,5/50x54 5
		25056st	34V4A	34,0– 29,0	29,0	55x60,5/50x54 5
		25056st	36V4A	36,0– 32,0	29,0	55x60,5/50x54 5
		25057st	40V4A **	40,0– 36,0	32,0	60x65 5
		25057st	40V4A **	40,0– 36,0	32,0	60x65 5
M63x1,5	10,0	26358st	44V4A **	44,0– 39,0	30,0	68x74/65x70 5

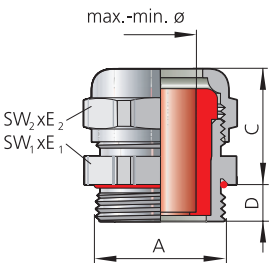
* Dichteinsatz kurz = Art.-Nr.: Ek... ** Dichteinsatz aus Silikon HT nicht lieferbar
* Sealing insert short = art. no.: Ek... ** Sealing insert silicone HT not available

Passende Gegenmuttern ab Seite 442
Corresponding locknuts see from page 442

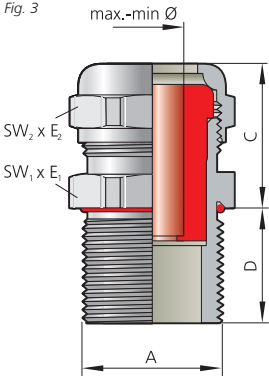
UNI Dicht-Kabelverschraubung

UNI Dicht cable gland



Abb. 1
Fig. 1



Abb. 2
Fig. 2

Polycarbonat, Farbe: grau (RAL 7035), schwarz (RAL 9005)
Metrisches Anschlussgewinde EN 60423
Schutzart IP 68 bis 10 bar, Type 4X
Zugentlastung bis Klasse A, EN 62444

Polycarbonate, colour: grey (RAL 7035), black (RAL 9005)
Metric connection thread EN 60423
Type of protection IP 68 up to 10 bar, Type 4X
Strain relief up to class A, EN 62444

i Schutzart IP 68/Type 4X ausschließlich in Verbindung mit separat erhältlicher Flachdichtung auf Seite 468
Type of protection IP 68/Type 4X only in combination with separately available flat seal ring on page 468

Werkstoff Verschraubungskörper <i>Material gland body</i>	Ausführung/Farbe <i>Version/colour</i>	Bestellschlüssel <i>Art. no. supplement</i>	Werkstoff Dichteinsatz <i>Material sealing insert</i>	Farbe <i>Colour</i>	Bestellschlüssel <i>Art. no. supplement</i>	Temperaturbereich min./max. <i>Temperature range (min./max.)</i>
PC	Grau Grey		TPE	s. FC s. CC		-20 °C / +100 °C
PC	Grau Grey		TPE-V	Natur Natural	p	-20 °C / +100 °C
PC	Grau Grey		Silikon HT Silicone HT	Schwarz Black	H	-20 °C / +100 °C
PC	Schwarz Black	n	TPE	s. FC s. CC		-20 °C / +100 °C
PC	Schwarz Black	n	TPE-V	Natur Natural	p	-20 °C / +100 °C
PC	Schwarz Black	n	Silikon HT Silicone HT	Schwarz Black	H	-20 °C / +100 °C



Abb. 3
Fig. 3

Anschlussgewinde/-länge <i>Connection thread/length</i>		Art.-Nr. <i>Art. no.</i>	Dichtbereich <i>Sealing range</i>	Bauhöhe <i>Mounting height</i>	Schlüsselweite <i>Spanner width</i>		
Ausführung bitte ergänzen <i>Please complete product details</i>							
A	D mm	Grau/Grey = p Schwarz/Black = n	= TPE = TPE-V = Silikon HT/Silicone HT	max./min. ø mm	C mm		
					SW₁ x E₁ / SW₂ x E₂ mm		
M12x1,5	8,0	21249PC	7 *	6,5 – 4,0	23,0	15x16,5	50
M16x1,5	9,0	21650PC	7	6,5 – 4,0	22,0	19x21,2	50
		21650PC	8	8,0 – 5,0	22,0	19x21,2	50
		21650PC	9	9,5 – 6,5	22,0	19x21,2	50
M20x1,5	9,0	22051PC	7	6,5 – 4,0	23,0	24x26,5/22x24,4	50
		22051PC	8	8,0 – 5,0	23,0	24x26,5/22x24,4	50
		22051PC	9	9,5 – 6,5	23,0	24x26,5/22x24,4	50
		22051PC	11	10,5 – 7,0	23,0	24x26,5/22x24,4	50
		22052PC	7 *	6,5 – 4,0	23,0	24x26,5	50
		22052PC	8 *	8,0 – 5,0	23,0	24x26,5	50
		22052PC	9 *	9,5 – 6,5	23,0	24x26,5	50
		22052PC	11 *	10,5 – 7,0	23,0	24x26,5	50
		22052PC	13 *	13,0 – 9,0	23,0	24x26,5	50
		22052PC	16 *	15,5 – 11,5	24,0	30x33,5/27x29,5	50
M25x1,5	9,0	22553PC	7	6,5 – 4,0	24,0	30x33,5/27x29,5	50
		22553PC	8	8,0 – 5,0	24,0	30x33,5/27x29,5	50
		22553PC	9	9,5 – 6,5	24,0	30x33,5/27x29,5	50
		22553PC	11	10,5 – 7,0	24,0	30x33,5/27x29,5	50
		22553PC	13	13,0 – 9,0	24,0	30x33,5/27x29,5	50
		22553PC	16	15,5 – 11,5	24,0	30x33,5/27x29,5	50
		22553PC	16	15,5 – 11,5	24,0	30x33,5/27x29,5	50
M32x1,5	11,0	23254PC	11	10,5 – 7,0	29,0	36x39,5/33x36,5	25
		23254PC	13	13,0 – 9,0	29,0	36x39,5/33x36,5	25
		23254PC	16	15,5 – 11,5	29,0	36x39,5/33x36,5	25
		23254PC	18	18,0 – 14,0	29,0	36x39,5/33x36,5	25
		23254PC	20	20,5 – 17,0	29,0	36x39,5/33x36,5	25
M40x1,5	11,5	24055PC	16	15,5 – 11,5	33,0	46x50/43x46,5	10
		24055PC	18	18,0 – 14,0	33,0	46x50/43x46,5	10
		24055PC	20	20,5 – 17,0	33,0	46x50/43x46,5	10
		24055PC	25	25,0 – 20,0	33,0	46x50/43x46,5	10
		24055PC	28	28,0 – 24,0	33,0	46x50/43x46,5	10
M50x1,5	14,0	25056PC	32	32,0 – 27,0	34,0	56x61/53x57	5
		25056PC	34	34,0 – 29,0	34,0	56x61/53x57	5
		25056PC	36	36,0 – 32,0	34,0	56x61/53x57	5

* Dichteinsatz kurz = Art.-Nr.: Ek...
 * Sealing insert short = art. no.: Ek...

i Passende Gegenmuttern ab Seite 442
Corresponding locknuts see from page 442

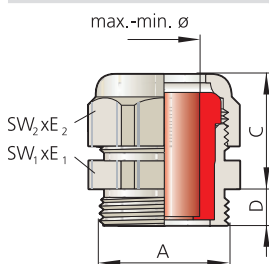
UNI Dicht-Kabelverschraubung

UNI Dicht cable gland



Abb. 1
Fig. 1



Abb. 2
Fig. 2

PVDF, Farbe: transparent, blau (RAL 5015), schwarz (RAL 9005)
Metrisches Anschlussgewinde EN 60423
Schutzart IP 68 bis 10 bar
Zugentlastung bis Klasse A, EN 62444

PVDF, colour: transparent, blue (RAL 5015), black (RAL 9005)
Metric connection thread EN 60423
Type of protection IP 68 up to 10 bar
Strain relief up to class A, EN 62444

Gewinde-Varianten: Standard-Maß D = 15 mm Länge
 Thread variants: Standard size D = 15 mm length
 = Art.-Nr. 22052...
 = Art.-Nr. 82052...
 = art. no. 22052...
 = art. no. 82052...

Werkstoff Verschraubungskörper Material gland body	Ausführung/Farbe Version/colour	Bestellschlüssel Art. no. supplement	Werkstoff Dichteinsatz Material sealing insert	Farbe Colour	Bestellschlüssel Art. no. supplement	Temperaturbereich min./max. Temperature range (min./max.)
PVDF	Transparent		TPE	s. FC s. CC		-40 °C / +130 °C
PVDF	Transparent		TPE-V	Natur Natural	p	-40 °C / +135 °C
PVDF	Transparent		Silikon HT Silicone HT	Schwarz Black	H	-40 °C / +150 °C
PVDF	Blau Blue	a	TPE	s. FC s. CC		-40 °C / +130 °C
PVDF	Blau Blue	a	TPE-V	Natur Natural	p	-40 °C / +135 °C
PVDF	Blau Blue	a	Silikon HT Silicone HT	Schwarz Black	H	-40 °C / +150 °C
PVDF	Schwarz Black	n	TPE	s. FC s. CC		-40 °C / +130 °C
PVDF	Schwarz Black	n	TPE-V	Natur Natural	p	-40 °C / +135 °C
PVDF	Schwarz Black	n	Silikon HT Silicone HT	Schwarz Black	H	-40 °C / +150 °C



Abb. 3
Fig. 3



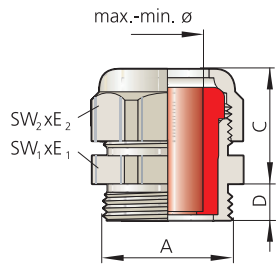

Abb. 4 – Ausführung lang/D = 15 mm
 Fig. 4 – Longer execution/D = 15 mm

Anschlussgewinde/-länge Connection thread/length	Art.-Nr. Art. no.	Ausführung bitte ergänzen Please complete product details	Dichtbereich Sealing range	Bauhöhe Mounting height	Schlüsselweite Spanner width		
A	D	Transparent = a = TPE Blau/Blue = a p = TPE-V Schwarz/Black = n H = Silikon HT/Silicone HT	max./min. Ø	C	SW₁ x E₁/SW₂ x E₂		
	mm		mm	mm	mm		
M12x1,5	8,0	21249y	7 *	6,5 – 4,0	23,0	15x16,5	50
		21650y	7	6,5 – 4,0	24,0	19x21/19x21,2	50
		21650y	8	8,0 – 5,0	24,0	19x21/19x21,2	50
		21650y	9	9,5 – 6,5	24,0	19x21/19x21,2	50
M20x1,5	9,0	22051y	7	6,5 – 4,0	23,0	24x26,5/22x24,4	50
		22051y	8	8,0 – 5,0	23,0	24x26,5/22x24,4	50
		22051y	9	9,5 – 6,5	23,0	24x26,5/22x24,4	50
		22051y	11	10,5 – 7,0	23,0	24x26,5/22x24,4	50
		22052y	7 *	6,5 – 4,0	25,0	24x26,5	50
		22052y	8 *	8,0 – 5,0	25,0	24x26,5	50
		22052y	9 *	9,5 – 6,5	25,0	24x26,5	50
		22052y	11 *	10,5 – 7,0	25,0	24x26,5	50
		22052y	13 *	13,0 – 9,0	25,0	24x26,5	50
M25x1,5	9,0	22553y	7	6,5 – 4,0	26,0	29x31,5/27x29,5	50
		22553y	8	8,0 – 5,0	26,0	29x31,5/27x29,5	50
		22553y	9	9,5 – 6,5	26,0	29x31,5/27x29,5	50
		22553y	11	10,5 – 7,0	26,0	29x31,5/27x29,5	50
		22553y	13	13,0 – 9,0	26,0	29x31,5/27x29,5	50
		22553y	16	15,5 – 11,5	26,0	29x31,5/27x29,5	50
M32x1,5	11,0	23254y	11	10,5 – 7,0	29,0	38x42/33x36,5	25
		23254y	13	13,0 – 9,0	29,0	38x42/33x36,5	25
		23254y	16	15,5 – 11,5	29,0	38x42/33x36,5	25
		23254y	18	18,0 – 14,0	29,0	38x42/33x36,5	25
		23254y	20	20,5 – 17,0	29,0	38x42/33x36,5	25

* Dichteinsatz kurz = Art.-Nr.: Ek...
 * Sealing insert short = art. no.: Ek...

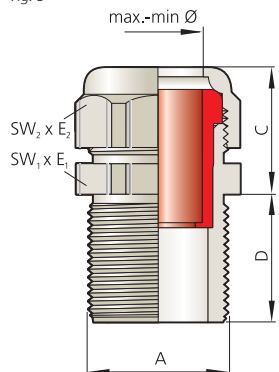
Fortsetzung auf der nächsten Seite
 Continued on next page

UNI Dicht-Kabelverschraubung
UNI Dicht cable gland
 Fortsetzung von vorheriger Seite
Continued from previous page

Anschlussgewinde/-länge Connection thread/length		Art.-Nr. Art. no.	Dichtbereich Sealing range	Bauhöhe Mounting height	Schlüsselweite Spanner width	
		Ausführung bitte ergänzen Please complete product details				
A	D	Transparent = = TPE Blau/Blue = a p = TPE-V Schwarz/Black = n H = Silikon HT/Silicone HT	max./min. ø	C	SW₁ x E₁/SW₂ x E₂	
	mm		mm	mm	mm	
M40x1,5	11,5	24055y	16	15,5 – 11,5	34,0	46x50/43x46
		24055y	18	18,0 – 14,0	34,0	46x50/43x46
		24055y	20	20,5 – 17,0	34,0	46x50/43x46
		24055y	25	25,0 – 20,0	34,0	46x50/43x46
		24055y	28	28,0 – 24,0	34,0	46x50/43x46
M50x1,5	13,0	25056y	32	32,0 – 27,0	35,0	56x61/53x57
		25056y	34	34,0 – 29,0	35,0	56x61/53x57
		25056y	36	36,0 – 32,0	35,0	56x61/53x57
M50x1,5	14,0	25057y	40 * * * * *	40,0 – 36,0	38,0	60x65
M63x1,5	14,0	26358y	44 * * * * *	44,0 – 39,0	41,0	68x73/65x70

* Dichteinsatz kurz = Art.-Nr.: Ek... ** Dichteinsatz aus Silikon HT nicht lieferbar *** Werkstoff POM (Farbe weiß), Temperaturbereich: -40 °C bis +110 °C. Es besteht keine CSA-Zulassung.
* Sealing insert short = art. no.: Ek... ** Sealing insert silicone HT not available *** Material POM (white colour), temperature range: -40 °C up to +110 °C, no CSA approval

i Schutzart IP 68 ausschließlich in Verbindung mit separat erhältlicher Flachdichtung auf Seite 468
Type of protection IP 68 only in combination with separately available flat sealing ring on page 468

UNI Dicht-Schottverschraubung

UNI Dicht bulkhead gland



Abb. 1
Fig. 1

Abb. 2
Fig. 2

Messing vernickelt
Metrisches Anschlussgewinde EN 60423
Sondergewindelänge: 50 mm (weitere auf Anfrage)
Mit O-Ring HNBR, Schutzart IP 68 bis 10 bar
Zugentlastung bis Klasse A, EN 62444

Brass, nickel-plated
 Metric connection thread EN 60423
 Special thread length: 50 mm (additional lengths available on request)
 With o-ring HNBR, type of protection IP 68 up to 10 bar
 Strain relief up to class A, EN 62444

i **Passende Gegenmuttern ab Seite 442**
 Corresponding locknuts see from page 442

Werkstoff Verschraubungskörper Material gland body	Ausführung/Farbe Version/colour	Werkstoff Dichteinsatz Material sealing insert	Farbe Colour	Bestellschlüssel Art. no. supplement	Temperaturbereich min./max. Temperature range (min./max.)
Messing Brass	Vernickelt Nickel-plated	TPE	s. FC s. CC		-40 °C / +130 °C
Messing Brass	Vernickelt Nickel-plated	TPE-V	Natur Natural	p	-40 °C / +135 °C
Messing Brass	Vernickelt Nickel-plated	Silikon HT Silicone HT	Schwarz Black	H	-55 °C / +200 °C



Abb. 3
Fig. 3

Anschlussgewinde/-länge Connection thread/length		Art.-Nr. Art. no.	Dichtbereich Sealing range	Bauhöhe Mounting height	Schlüsselweite Spanner width		
		Ausführung bitte ergänzen Please complete product details					
A	D mm	TPE = TPE-V = p Silikon HT/Silicone HT = H	max./min. ø mm	C mm	SW₁ x E₁/SW₂ x E₂ mm		
M20x1,5	50,0	22052d	7/50lg	6,5 – 4,0	21,0	22x24,4	10
		22052d	8/50lg	8,0 – 5,0	21,0	22x24,4	10
		22052d	9/50lg	9,5 – 6,5	21,0	22x24,4	10
		22052d	11/50lg	10,5 – 7,0	21,0	22x24,4	10
		22052d	13/50lg	13,0 – 9,0	21,0	22x24,4	10
M25x1,5	50,0	22553d	7/50lg	6,5 – 4,0	21,0	28x31,2/24x26,7	10
		22553d	8/50lg	8,0 – 5,0	21,0	28x31,2/24x26,7	10
		22553d	9/50lg	9,5 – 6,5	21,0	28x31,2/24x26,7	10
		22553d	11/50lg	10,5 – 7,0	21,0	28x31,2/24x26,7	10
		22553d	13/50lg	13,0 – 9,0	21,0	28x31,2/24x26,7	10
		22553d	16/50lg	15,5 – 11,5	21,0	28x31,2/24x26,7	50
M32x1,5	50,0	23254d	11/50lg	10,5 – 7,0	26,0	35x38,5/30x33,5	5
		23254d	13/50lg	13,0 – 9,0	26,0	35x38,5/30x33,5	5
		23254d	16/50lg	15,5 – 11,5	26,0	35x38,5/30x33,5	5
		23254d	18/50lg	18,0 – 14,0	26,0	35x38,5/30x33,5	5
		23254d	20/50lg	20,5 – 17,0	26,0	35x38,5/30x33,5	5
M40x1,5	50,0	24055d	16/50lg	15,5 – 11,5	29,0	43x47,3/40x43,5	5
		24055d	18/50lg	18,0 – 14,0	29,0	43x47,3/40x43,5	5
		24055d	20/50lg	20,5 – 17,0	29,0	43x47,3/40x43,5	5
		24055d	25/50lg	25,0 – 20,0	29,0	43x47,3/40x43,5	5
		24055d	28/50lg	28,0 – 24,0	29,0	43x47,3/40x43,5	5

11600 | TTP0403

UNI Dicht Erweitert – metrisch

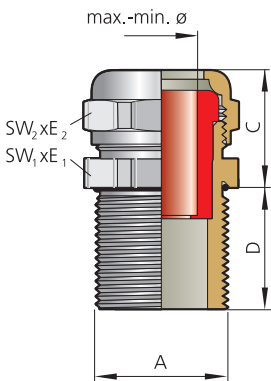
UNI Dicht Extended – metric



Abb. 1 – UNI Dicht Erweitert Messing
Fig. 1 – UNI Dicht Extended brass

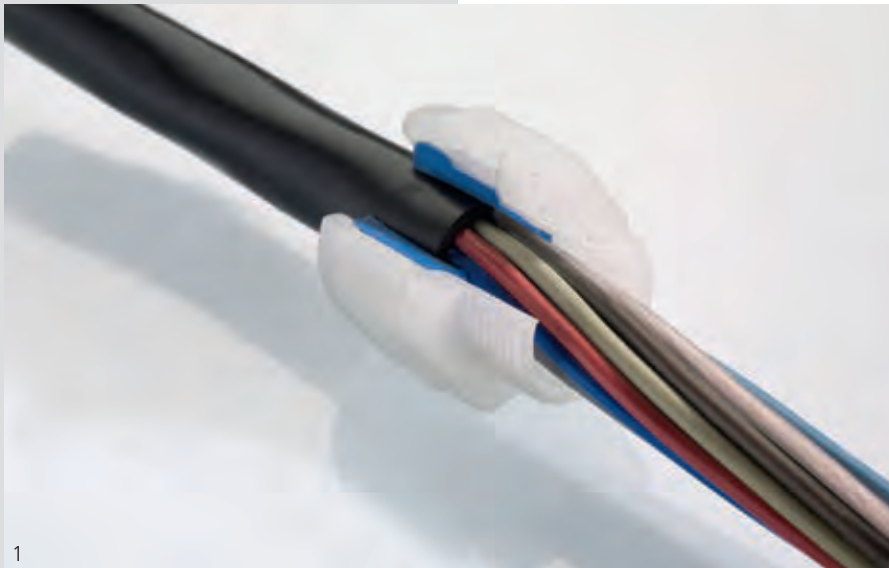

1



2

Dicke Kabel durch kleine Bohrung

Sollen Kabel mit dickerem Durchmesser durch eine bestehende Bohrung geführt werden, lässt sich das mit sogenannten „erweiterten“ Doppelnippeln einfach realisieren. Diese verfügen über ein vergrößertes Kopfteil für die Aufnahme eines entsprechend kurzen Dichtensatzes. Das abgemantelte Kabel mit seinem deutlich kleineren Adernquerschnitt wird sicher durch den Anschlussbereich der Kabelverschraubung geführt.

Thick cables through small boreholes

If a thicker cable has to be fed through an existing hole, this can be simply done with an "extended" double nipple. This has an enlarged head to accept a correspondingly short sealing insert. The unsheathed cable with its significantly smaller diameter can be fitted easily through the connection area of the cable gland.

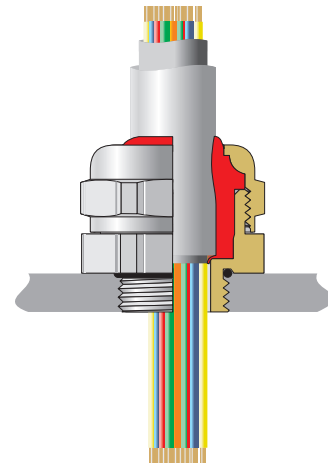

3

Abb. 1 – UNI Dicht Erweitert PVDF
Fig. 1 – UNI Dicht Extended PVDF

Abb. 2 – UNI Dicht Erweitert PVDF
Fig. 2 – UNI Dicht Extended PVDF

Abb. 3 – Querschnitt UNI Dicht Erweitert
Fig. 3 – Cross section UNI Dicht Extended

UNI Dicht Erweitert

UNI Dicht Extended



Abb. 1
Fig. 1



Abb. 2
Fig. 2

Messing vernickelt
Metrisches Anschlussgewinde EN 60423
Mit O-Ring HNBR
Schutzart IP 68 bis 10 bar, Type 4X
Zugentlastung bis Klasse A, EN 62444

Brass, nickel-plated
Metric connection thread EN 60423
With o-ring HNBR
Type of protection IP 68 up to 10 bar, Type 4X
Strain relief up to class A, EN 62444

i **Achtung: Dichteinsätze mit kurzer Bauform Art.-Nr.: Ek... verwenden**
Note: Only use short sealing inserts art. no.: Ek...

Werkstoff Verschraubungskörper Material gland body	Ausführung/Farbe Version/colour	Werkstoff Dichteinsatz Material sealing insert	Farbe Colour	Bestellschlüssel Art. no. supplement	Temperaturbereich min./max. Temperature range (min./max.)
Messing Brass	Vernickelt Nickel-plated	TPE	s. FC s. CC		-40 °C / +130 °C
Messing Brass	Vernickelt Nickel-plated	TPE-V	Natur Natural	p	-40 °C / +135 °C
Messing Brass	Vernickelt Nickel-plated	Silikon HT Silicone HT	Schwarz Black	H	-55 °C / +200 °C



Abb. 3
Fig. 3

Anschlussgewinde/-länge Connection thread/length	Art.-Nr. Art. no.	Dichtbereich Sealing range	Innendurchmesser Inner diameter	Durchlass Druckschraube max. Opening pressure screw max.	Bauhöhe Mounting height	Schlüsselweite Spanner width			
Ausführung bitte ergänzen Please complete product details									
A	D mm	TPE = p TPE-V = p Silikon HT/Silicone HT = H	max./min. ø mm	E mm	F mm	C mm			
						SW x E mm			
M12x1,5	5,0	21250d	8	8,0– 5,0	7,5	10,0	21,0	17x18,9	50
		21250d	9	9,5– 6,5	7,5	10,0	21,0	17x18,9	50
M16x1,5	6,0	21651d	11	10,5– 7,0	12,0	11,5	21,0	20x22,2	50
		21652d	13	13,0– 9,0	12,0	13,5	21,0	22x24,4	50
M20x1,5	6,5	22053d	16	15,5– 11,5	16,0	16,0	21,0	24x26,7	50
		22054d	18	18,0– 14,0	16,0	18,5	24,0	30x33,5	25
		22054d	20	20,5– 17,0	16,0	20,0	24,0	30x33,5	25
M25x1,5	7,5	22554d	18	18,0– 14,0	20,5	18,5	26,0	30x33,5	25
		22554d	20	20,5– 17,0	20,5	21,0	26,0	30x33,5	25
M32x1,5	8,0	23255d	25	25,0– 20,0	26,5	29,0	29,0	40x43,5	10
		23255d	28	28,0– 24,0	26,5	29,0	29,0	40x43,5	10
		23256d	32	32,0– 27,0	26,0	38,0	28,0	50x54	5
		23256d	34	34,0– 29,0	26,0	38,0	28,0	50x54	5
		23256d	36	36,0– 32,0	26,0	38,0	28,0	50x54	5
M40x1,5	9,0	24056d	32	32,0– 27,0	34,5	38,0	28,0	50x54	10
		24056d	34	34,0– 29,0	34,5	38,0	28,0	50x54	10
		24056d	36	36,0– 32,0	34,5	38,0	28,0	50x54	10
M50x1,5	10,0	25057d	38 *	38,0– 34,0	42,0	42,0	32,0	57x61	5
		25057d	40 *	40,0– 36,0	42,0	42,0	32,0	57x61	5

* Dichteinsatz aus Silikon HT nicht lieferbar
* Sealing insert silicone HT not available

i **Passende Gegenmuttern ab Seite 442**
Corresponding locknuts see from page 442

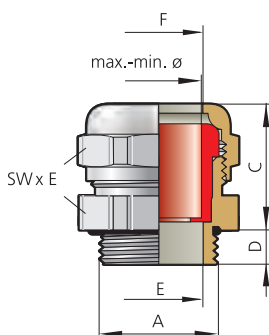
UNI Dicht Erweitert

UNI Dicht Extended



Abb. 1
Fig. 1



Abb. 2
Fig. 2

Polycarbonat, Farbe: grau (RAL 7035), schwarz (RAL 9005)
Metrisches Anschlussgewinde EN 60423
Schutzart IP 68 bis 10 bar, Type 4X
Zugentlastung bis Klasse A, EN 62444

Polycarbonate, colour: grey (RAL 7035), black (RAL 9005)
 Metric connection thread EN 60423
 Type of protection IP 68 up to 10 bar, Type 4X
 Strain relief up to class A, EN 62444

i Achtung: Dichteinsätze mit kurzer Bauform Art.-Nr.: Ek... verwenden
 Note: Only use short sealing inserts art. no.: Ek...

Werkstoff Verschraubungskörper Material gland body	Ausführung/Farbe Version/colour	Bestellschlüssel Art. no. supplement	Werkstoff Dichteinsatz Material sealing insert	Farbe Colour	Bestellschlüssel Art. no. supplement	Temperaturbereich min./max. Temperature range (min./max.)
PC	Grau Grey		TPE	s. FC s. CC		-20 °C / +100 °C
PC	Grau Grey		TPE-V	Natur Natural	p	-20 °C / +100 °C
PC	Grau Grey		Silikon HT Silicone HT	Schwarz Black	H	-20 °C / +100 °C
PC	Schwarz Black	n	TPE	s. FC s. CC		-20 °C / +100 °C
PC	Schwarz Black	n	TPE-V	Natur Natural	p	-20 °C / +100 °C
PC	Schwarz Black	n	Silikon HT Silicone HT	Schwarz Black	H	-20 °C / +100 °C



Abb. 3
Fig. 3

Anschlussgewinde/-länge Connection thread/length	Art.-Nr. Art. no.	Dichtbereich Sealing range	Innendurchmesser Inner diameter	Durchlass Druckschraube max. Opening pressure screw max.	Bauhöhe Mounting height	Schlüsselweite Spanner width			
	Ausführung bitte ergänzen Please complete product details								
		= TPE							
A	D	Grau/Grey = p = TPE-V	max./min. ø	E	F	C			
	mm	Schwarz/Black = n H = Silikon HT/ Silicone HT	mm	mm	mm	mm			
M12x1,5	8,0	21250PC	8	8,0 – 5,0	7,0	10,0	22,0	19x21,2	50
		21250PC	9	9,5 – 6,5	7,0	10,0	22,0	19x21,2	50
M16x1,5	8,5	21651PC	11	10,5 – 7,0	11,5	11,0	23,0	22x24,5	50
		21652PC	13	13,0 – 9,0	11,5	13,5	24,0	24x26,5	50
M20x1,5	9,0	22053PC	11	10,5 – 7,0	13,5	16,0	24,0	27x29,5	50
		22053PC	16	15,5 – 11,5	13,5	16,0	24,0	27x29,5	50
M25x1,5	11,0	22554PC	18	18,0 – 14,0	20,5	21,0	29,0	33x36,5	25
		22554PC	20	20,5 – 17,0	20,5	21,0	29,0	33x36,5	25
		22555PC	20	20,5 – 17,0	20,5	28,0	29,0	43x46	25
		22555PC	25	25,0 – 20,0	20,5	28,0	29,0	43x46	25
		22555PC	28	28,0 – 24,0	20,5	28,0	29,0	43x46	25
M32x1,5	11,0	23255PC	25	25,0 – 20,0	25,0	28,0	32,0	43x46	10
		23255PC	28	28,0 – 24,0	25,0	28,0	32,0	43x46	10
M40x1,5	13,0	24056PC	32	32,0 – 27,0	34,5	37,0	35,0	53x57	5
		24056PC	34	34,0 – 29,0	34,5	37,0	35,0	53x57	5
		24056PC	36	36,0 – 32,0	34,5	37,0	35,0	53x57	5

12200 | IT00530

i Schutzart IP 68/Type 4X ausschließlich in Verbindung mit separat erhältlicher Flachdichtung auf Seite 468
 Type of protection IP 68/Type 4X only in combination with separately available flat seal ring on page 468

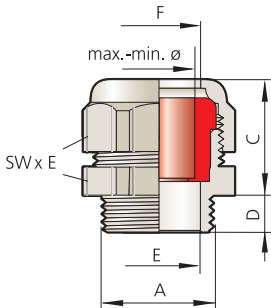
i Passende Gegenmuttern ab Seite 442
 Corresponding locknuts see from page 442

UNI Dicht Erweitert

UNI Dicht Extended



Abb. 1
Fig. 1



Abb. 2
Fig. 2

PVDF, Farbe: transparent, blau (RAL 5015), schwarz (RAL 9005)
Metrisches Anschlussgewinde EN 60423
Schutzart IP 68 bis 10 bar
Zugentlastung bis Klasse A, EN 62444

PVDF, colour: transparent, blue (RAL 5015), black (RAL 9005)
Metric connection thread EN 60423
Type of protection IP 68 up to 10 bar
Strain relief up to class A, EN 62444

i Achtung: Dichteinsätze mit kurzer Bauform Art.-Nr.: Ek... verwenden
 Note: Only use short sealing inserts art. no.: Ek...

Werkstoff Verschraubungskörper Material gland body	Ausführung/Farbe Version/colour	Bestellschlüssel Art. no. supplement	Werkstoff Dichteinsatz Material sealing insert	Farbe Colour	Bestellschlüssel Art. no. supplement	Temperaturbereich min./max. Temperature range (min./max.)
PVDF	Transparent		TPE	s. FC s. CC		-40 °C / +130 °C
PVDF	Transparent		TPE-V	Natur Natural	p	-40 °C / +135 °C
PVDF	Transparent		Silikon HT Silicone HT	Schwarz Black	H	-40 °C / +150 °C
PVDF	Blau Blue	a	TPE	s. FC s. CC		-40 °C / +130 °C
PVDF	Blau Blue	a	TPE-V	Natur Natural	p	-40 °C / +135 °C
PVDF	Blau Blue	a	Silikon HT Silicone HT	Schwarz Black	H	-40 °C / +150 °C
PVDF	Schwarz Black	n	TPE	s. FC s. CC		-40 °C / +130 °C
PVDF	Schwarz Black	n	TPE-V	Natur Natural	p	-40 °C / +135 °C
PVDF	Schwarz Black	n	Silikon HT Silicone HT	Schwarz Black	H	-40 °C / +150 °C



Abb. 3
Fig. 3

Anschlussgewinde/-länge Connection thread/length	Art.-Nr. Art. no.	Dichtbereich Sealing range	Innendurchmesser Inner diameter	Durchlass Druckschraube max. Opening pressure screw max.	Bauhöhe Mounting height	Schlüsselweite Spanner width
	Ausführung bitte ergänzen Please complete product details					
A	D	max./min. ø	E	F	C	SW x E
	mm	mm	mm	mm	mm	mm
M16x1,5	8,5	9 – 6,5	11,5	11,0	23,0	22x24,5 50
		10,5 – 7,0	11,5	11,0	23,0	22x24,5 50
M16x1,5	11,0	10,5 – 7,0	11,5	13,0	25,0	24x26,5 50
		13,0 – 9,0	11,5	13,0	25,0	24x26,5 50
M20x1,5	9,0	15,5 – 11,5	13,5	16,0	26,0	27x29,5 50
M20x1,5	11,0	15,5 – 11,5	15,5	21,0	29,0	33x36,5 50
		18,0 – 14,0	15,5	21,0	29,0	33x36,5 50
		20,5 – 17,0	15,5	21,0	29,0	33x36,5 50
M25x1,5	11,0	15,5 – 11,5	19,0	21,0	29,0	33x36,5 25
		18,0 – 14,0	19,0	21,0	29,0	33x36,5 25
		20,5 – 17,0	19,0	21,0	29,0	33x36,5 25
		18,0 – 14,0	20,5	28,0	33,0	43x46 25
		20,5 – 17,0	20,5	28,0	33,0	43x46 25
		25,0 – 20,0	20,5	28,0	33,0	43x46 25
		28,0 – 24,0	20,5	28,0	33,0	43x46 25
M32x1,5	11,0	25,0 – 20,0	25,0	28,0	33,0	43x46 10
		28,0 – 24,0	25,0	28,0	33,0	43x46 10
M40x1,5	13,0	32,0 – 27,0	34,5	37,0	35,0	53x57 5
		34,0 – 29,0	34,5	37,0	35,0	53x57 5
		36,0 – 32,0	34,5	37,0	35,0	53x57 5

i Schutzart IP 68 ausschließlich in Verbindung mit separat erhältlicher Flachdichtung auf Seite 468
 Type of protection IP 68 only in combination with separately available flat sealing ring on page 468

UNI Dicht 2M

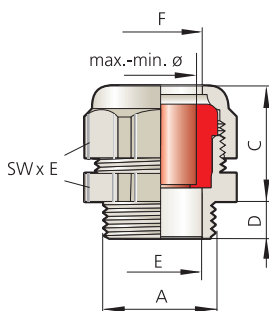

Abb. 1 – UNI Dicht 2M mit großem Dichtbereich
Fig. 1 – UNI Dicht 2M with large sealing range

Abb. 2 – UNI Dicht 2M in der Explosionsansicht
Fig. 2 – Exploded view of UNI Dicht 2M

Die UNI Dicht 2M ist eine Ergänzung des PFLITSCH-Produktportfolios. Große Dichtbereiche sowie ein großer Durchlass am Doppelnippel für die Durchführung konfektionierter Kabel sind prägnante Eigenschaften dieser Kabelverschraubung.

Die UNI Dicht 2M verbindet die hohe Qualität des UNI Dicht-Systems mit den Anforderungen, bei denen hohe Stückzahlen zu wirtschaftlichen Konditionen benötigt werden. Diese Kabelverschraubung ist in komplett metrischer Ausführung erhältlich. Die UNI Dicht 2M mit ihrem Verschraubungskörper aus Messing gibt es in den gängigen Größen M16 bis M40.

Diese Variante benötigt nur noch einen Montageschlüssel, da der Doppelnippel und die Druckschraube identische Schlüsselweiten haben. Darüber hinaus punktet die UNI Dicht 2M durch eine optimierte Schlüsselweite und eine geringe Bauhöhe, sodass bei der Installation eine hohe Packungsdichte und somit sehr geringe Lochabstände möglich sind. Durch die großen Dichtbereiche kann in vielen Fällen mit einem kleineren Anschlussgewinde gearbeitet werden. Das spart Kosten und Platz bei der Montage.

Bei der UNI Dicht 2M wird das gleiche Dichtprinzip wie im UNI Dicht-System angewendet. Die Systemmaße sind unterschiedlich, weswegen die Varianten wie Mehrfach, Schlauch und EMV weiterhin aus dem Standard UNI Dicht-System abgedeckt werden.

Ihre Vorteile:

- Größere Dichtbereiche als im Standard
- Geringe Bauhöhe
- Kleinere Anschlussgewinde

The UNI Dicht 2M is an addition to the product portfolio. Large sealing ranges and a larger entry to the double nipples in order to route pre-assembled cables are the new qualities of these cable glands.

The UNI Dicht 2M combines the high quality of the UNI Dicht system with the demands of an application where large volumes are required at economical conditions. This new cable gland is available in a completely metric version. The UNI Dicht 2M, with its gland made of brass, is available in sizes M16 to M40.

This variant needs only one assembly tool because the double nipple and the pressure screw have identical spanner widths. Moreover, the UNI Dicht 2M has an optimised spanner width and a small mounting height, which produces highly compact installations with very close hole centres. In many cases, the large sealing ranges allow smaller threaded connections to be used. This saves cost and space in the installation.

In the UNI Dicht 2M the same sealing principle is used as in the UNI Dicht system. The system dimensions are diverse, and therefore the variations multiple, hoses and EMC are covered by the standard UNI Dicht system.

Your advantages:

- Larger sealing ranges than standard version
- Small mounting height
- Smaller connection thread



Abb. 1 – UNI Dicht 2M im montierten Zustand
Fig. 1 – UNI Dicht 2M in assembled state

UNI Dicht 2M-Kabelverschraubung

UNI Dicht 2M cable gland



Abb. 1
Fig. 1



Abb. 2
Fig. 2

Messing vernickelt
Metrisches Kopf- und Anschlussgewinde EN 60423
Mit O-Ring HNBR
Schutzart IP 68 bis 10 bar
Zugentlastung bis Klasse A, EN 62444

Brass, nickel-plated
Metric head and connection thread EN 60423
With o-ring HNBR
Type of protection IP 68 up to 10 bar
Strain relief up to class A, EN 62444

i Ausführung UNI Ex Dicht 2M auf Seite 301
Version UNI Ex Dicht 2M on page 301

Werkstoff Verschraubungskörper Material gland body	Ausführung/Farbe Version/colour	Werkstoff Dichteinsatz Material sealing insert	Farbe Colour	Temperaturbereich min./max. Temperature range (min./max.)
Messing Brass	Vernickelt Nickel-plated	TPE	Moosgrün Moss green	-40 °C / +130 °C



Abb. 3
Fig. 3

Anschlussgewinde/-länge Connection thread/length	Art.-Nr. Art. no.	Dichtbereich Sealing range	Bauhöhe Mounting height	Schlüsselweite Spanner width	
A	D mm	max./min. ø mm	C mm	SW x E mm	
M16x1,5	21618d 6	6,5– 4,0	19,0	20x22,2	500
	21618d 8	8,5– 6,0	19,0	20x22,2	500
	21618d11	11,5– 8,0	19,0	20x22,2	500
M20x1,5	22020d 9	9,0– 6,5	19,0	22x24,9	500
	22020d12	12,0– 8,5	19,0	22x24,9	500
	22020d14	14,0– 10,0	19,0	22x24,9	500
	22022d15	15,5– 11,5	19,0	24x26,7	500
M25x1,5	22528d11	11,0– 8,0	22,0	30x33,5	500
	22528d14	14,0– 10,5	22,0	30x33,5	500
	22528d17	17,0– 13,5	22,0	30x33,5	500
	22528d20	20,5– 16,5	22,0	30x33,5	500
M32x1,5	23234d16	16,5– 13,0	25,0	36x39,5	250
	23234d19	19,5– 16,0	25,0	36x39,5	250
	23234d22	22,5– 19,0	25,0	36x39,5	250
	23234d26	26,0– 22,0	25,0	36x39,5	250
M40x1,5	24042d24	24,0– 20,5	28,0	45x48	100
	24042d27	27,0– 23,5	28,0	45x48	100
	24042d30	30,0– 26,5	28,0	45x48	100
	24042d33	33,5– 29,5	28,0	45x48	100

483300 | TT00720

UNI Mehrfach – metrisch

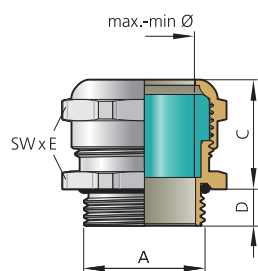
UNI Multiple – metric



Abb. 1 – UNI Mehrfach montiert
Fig. 1 – Assembled UNI Multiple

Abb. 2 – UNI Mehrfach und Verschlussbolzen für nicht belegte Löcher
Fig. 2 – UNI Multiple and bolt for unused holes

Abb. 3 – UNI Mehrfach-Dichteinsätze mit unterschiedlichen Lochbildern
Fig. 3 – UNI Multiple sealing inserts with different hole patterns

Mehrere Kabel sicher durch eine Bohrung führen

Wer aus Platz- oder Handlinggründen mehrere Kabel sicher durch eine Bohrung führen möchte, ersetzt den Standard-Dichteinsatz einfach durch Typen aus dem UNI Mehrfach-Programm. Verschiedene Lochbilder stehen zur Verfügung, sodass sich auch unterschiedliche Kabeldurchmesser abdichten lassen. Dabei erreicht die UNI Mehrfach die Schutzart IP 65, wenn die Differenz von Kabeldurchmesser und Loch weniger als 10 % beträgt. Sind beide gleich, lässt sich auch IP 68 (bis 10 bar) erreichen. Dichtigkeit und Zugentlastung sind abhängig vom verwendeten Kabel. Entsprechende Tests bietet PFLITSCH im eigenen Prüflabor an.

Dichteinsätze nach Kundenwunsch

PFLITSCH fertigt diese Dichteinsätze exakt nach Kundenvorgabe aus dem hochwertigen Kunststoff TPE-V, der Einsatztemperaturen von -40 °C bis +135 °C erlaubt. Dank dieser Fertigungsmethode kann PFLITSCH selbst Prototypen und Kleinserien zu wirtschaftlichen Preisen realisieren. Alternativ kann der Kunde geschlossene Dichteinsätze selbst mit Lochungen versehen. Nicht belegte Löcher werden mit einem Verschlussbolzen abgedichtet. Neben den runden Lochungen fertigt PFLITSCH auch Varianten für unterschiedliche Flach- oder Sonderkabel, beispielsweise für den ASI-Bus oder für Kabel, die mit Trageilen ausgestattet sind.

Dichteinsätze für konfektionierte Kabel

Die Mehrfach-Dichteinsätze gibt es auch geteilt, z. B. für die Abdichtung von Kabeln, die bereits mit Steckern oder Sensoren konfektioniert sind. Diese Bauteile werden durch den Verschraubungskörper geführt, bevor die Kabel von den zwei Hälften des Dichteinsatzes zuverlässig umschlossen werden.

Für den gleichen Anwendungsfall bieten sich die seitlich geschlitzten Dichteinsätze an: Durch den nach außen offenen Schlitz lassen sich Kabel unkompliziert einführen.

Inserting several cables securely through a borehole

Users intending to thread several cables reliably through a borehole for space or handling reasons can replace the standard sealing insert with types from the UNI Multiple range. A number of hole patterns are available, so that a variety of cable diameters can also be sealed. Here UNI Multiple achieves protection class IP 65, when the difference between the cable diameter and breakthrough is less than 10%. Should the values be the same, IP 68 (up to 10 bar) can be achieved. The tightness and strain relief depend on the cable used. PFLITSCH conducts the corresponding testing in its own test laboratory.

Sealing inserts according to customer wishes

PFLITSCH manufactures these sealing inserts exactly according to customer wishes from the high-grade plastic TPE-V, permitting application temperatures from -40 °C to +135 °C. Due to this production method, PFLITSCH can realise even prototypes and short runs economically. Alternatively, with a slowly running drill customers can make their own holes in closed sealing inserts. Unused holes are sealed with a bolt. In addition to the round perforations, PFLITSCH also produces variants for different flat cables or special cables, for example, for the ASI-Bus or for cables with track cables.

Sealing inserts for ready-made cables

The multiple sealing inserts also come split, e.g. for sealing cables, already made up with connectors or sensors. These components are threaded through the gland body before the cables are reliably enclosed by the two halves of the sealing insert.

The laterally slotted sealing inserts also lend themselves to this application: Cables can be inserted through the slot open to the outside.



Abb. 1 – Geteilter Mehrfach-Dichteinsatz
Fig. 1 – Split multiple sealing insert

Abb. 2 – Kabelverschraubung für zwei ASI-Bus-Kabel
Fig. 2 – Cable gland for two ASI-Bus cables

UNI Mehrfach-Kabelverschraubung

UNI Multiple cable gland



Abb. 1
Fig. 1



Abb. 2
Fig. 2

Messing vernickelt, Edelstahl 1.4305, Polycarbonat, PVDF
Metrisches Anschlussgewinde gemäß EN 60423
Schutzart IP 65
Schutzart IP 68 bis 10 bar, wenn Kabel- ϕ = Loch- ϕ , Type 4X
Zugentlastung bis Klasse A, EN 62444

Brass, nickel-plated, stainless steel AISI 303, polycarbonate, PVDF
Metric connection thread EN 60423

Type of protection IP 65
Type of protection IP 68 up to 10 bar, achievable if cable ϕ = hole ϕ , Type 4X
Strain relief up to class A, EN 62444

Werkstoff Verschraubungskörper Material gland body	Ausführung/Farbe Version/colour	Bestellschlüssel Art. no. supplement	Werkstoff Dichteinsatz Material sealing insert	Farbe Colour	Bestellschlüssel Art. no. supplement	Temperaturbereich min./max. Temperature range (min./max.)
Messing Brass	Vernickelt Nickel-plated	d	TPE	Weiß White		-40 °C / +130 °C
Messing Brass	Vernickelt Nickel-plated	d	TPE-V	Natur Natural	p	-40 °C / +135 °C
VA 1.4305 AISI 303	Blank	st	TPE	Weiß White		-40 °C / +130 °C
VA 1.4305 AISI 303	Blank	st	TPE-V	Natur Natural	p	-40 °C / +135 °C
PC	Grau Grey	PC	TPE	Weiß White		-20 °C / +100 °C
PC	Grau Grey	PC	TPE-V	Natur Natural	p	-20 °C / +100 °C
PVDF	Transparent	y	TPE	Weiß White		-40 °C / +130 °C
PVDF	Transparent	y	TPE-V	Natur Natural	p	-40 °C / +135 °C



Abb. 3 – Beispiel „2 x 3“
 2 = Anzahl Bohrungen
 3 = Bohrungsdurchmesser in mm
 Fig. 3 – Example „2 x 3“
 2 = number of bores
 3 = bore hole diameter in mm

Anschlussgewinde Connection thread	Art.-Nr. Art. no.	Ausführung bitte ergänzen Please complete product details	
A	Messing/Brass	= d	
	VA 1.4305/AISI 303	= st	
	PC	= PC	= TPE
	PVDF	= y	p = TPE-V
M6x0,8	206	m2x1 *	50
M10x1,0	21049	m1x3/1mm *	50
	21049	m1x4/1mm *	50
	21049	m1x5/1mm *	50
M10x1,5	21049	m1x3/1,5mm *	50
	21049	m1x4/1,5mm *	50
	21049	m1x5/1,5mm *	50
M12x1,5	21249	m1x3	50
	21249	m1x4	50
	21249	m1x5	50
	21249	m2x3	50
	21250	m1x5 **	50
	21250	m2x3 **	50
	21250	m2x4 **	50
21250	m3x3 **	50	
M16x1,5	21650	m1x1,5S/1x4	50
	21650	m1x3	50
	21650	m1x4	50
	21650	m1x5	50
	21650	m2x1,2	50
	21650	m2x3	50
	21650	m2x3,3	50
	21650	m2x4	50
	21650	m3x3	50
	21650	m3x3,5	50
21650	m4x1,4	50	

* Variante in y und PC nicht erhältlich ** Dichteinsatz kurz = Art.-Nr.: Ek...
 * Variant in y and PC not available ** Sealing insert short = art. no.: Ek...

Fortsetzung auf der nächsten Seite
 Continued on next page

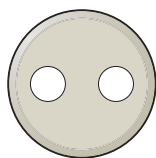
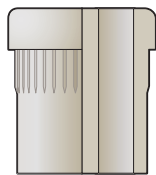
UNI Mehrfach-Kabelverschraubung

UNI Multiple cable gland

Fortsetzung von vorheriger Seite
Continued from previous page

Anschlussgewinde		Art.-Nr.	
Connection thread		Art. no.	
Ausführung bitte ergänzen Please complete product details			
	Messing/Brass	= d	
	VA 1.4305/AISI 303	= st	
A	PC	= PC	= TPE
	PVDF	= y	p = TPE-V
M16x1,5	21650	m4x2	50
	21650	m4x3	50
	21650	m4x3,3	50
	21650	m5x1,4	50
	21651	m1x2/2x4 *	50
	21651	m1x4/1x6 *	50
	21651	m2x3/1x5 *	50
	21651	m2x5 *	50
	21651	m6x2 *	50
	21652	m1x4,7/1x6,4 *	50
	21652	m2x2,5/2x6 *	50
	21652	m2x3 *	50
	21652	m2x4 *	50
	21652	m2x5 *	50
	21652	m2x6 *	50
	21652	m3x4 *	50
	21652	m3x5	50
	21652	m3x5,3 *	50
	21652	m4x4 *	50
	21652	m8x1,5 *	50
21652	m8x3 *	50	
M20x1,5	22051	m1x3	50
	22051	m1x3/1x6	50
	22051	m1x4	50
	22051	m1x5	50
	22051	m2x2,3	50
	22051	m2x3	50
	22051	m2x4	50
	22051	m2x5	50
	22051	m2x6	50
	22051	m3x1,5	50
	22051	m3x3	50
	22051	m3x4	50
	22051	m4x1,5	50
	22051	m4x2,5/1x3,5	50
	22051	m5x2,5	50
	22051	m5x3,5	50
	22051	m6x2,5	50
	22051	m7x1,5	50
	22051	m9x1,5	50
	22052	m1x2/3x3 **	50
	22052	m1x2,5 **	50
	22052	m1x3 **	50
	22052	m1x3/2x6 **	50
	22052	m1x3,5/1x6 **	50
	22052	m1x3,5/2x4,5 **	50
	22052	m1x4 **	50

Anschlussgewinde		Art.-Nr.	
Connection thread		Art. no.	
Ausführung bitte ergänzen Please complete product details			
	Messing/Brass	= d	
	VA 1.4305/AISI 303	= st	
A	PC	= PC	= TPE
	PVDF	= y	p = TPE-V
M20x1,5	22052	m1x4,7/1x6,4 **	50
	22052	m1x5 **	50
	22052	m1x5,5/1x6 ** ***	50
	22052	m1x8S **	50
	22052	m2x3 **	50
	22052	m2x4 ** ***	50
	22052	m2x4/1x5,5 **	50
	22052	m2x4,5 **	50
	22052	m2x5 **	50
	22052	m2x5/1x5,5 **	50
	22052	m2x6 **	50
	22052	m3x1,9/1x6 **	50
	22052	m3x2 **	50
	22052	m3x3 **	50
	22052	m3x3/1x6 **	50
	22052	m3x4 **	50
	22052	m3x5,3 **	50
	22052	m3x5,3S **	50
	22052	m4x3 **	50
	22052	m4x4 **	50
	22052	m5x2 **	50
	22052	m6x2,5 **	50
	22052	m6x3,5 **	50
	22052	m7x3,3 **	50
	22052	m8x1,5 **	50
	22052	m8x2 **	50
	22052	m8x3 ** ***	50
	22052	m10x2 **	50
	22052	m10x2,6 ** ***	50
	22053	m1x3/1x6/1x8 *	50
	22053	m1x5/1x9 *	50
	22053	m1x6/1x8 *	50
22053	m2x3,2/2x6 *	50	
22053	m2x3,5 *	50	
22053	m2x4 *	50	
22053	m2x5 *	50	
22053	m2x5,3/1x6,3 *	50	
22053	m2x6 *	50	
22053	m2x6/1x7 *	50	
22053	m2x6,5 *	50	
22053	m2x7 *	50	
22053	m2x8 *	50	
22053	m3x5/1x8 *	50	
22053	m3x6 *	50	
22053	m3x7 *	50	
22053	m4x5 *	50	

* Dichteinsatz kurz = Art.-Nr.: Ek... ** Bei Variante y und PC Dichteinsatz kurz = Art.-Nr.: Ek... *** Variante in d und st nicht erhältlich
* Sealing insert short = art. no.: Ek... ** Variant y and PC sealing insert short = art. no.: Ek... *** Variant in d and st not available

Fortsetzung auf der nächsten Seite
Continued on next page

UNI Mehrfach-Kabelverschraubung

UNI Multiple cable gland

Fortsetzung von vorheriger Seite
Continued from previous page

Anschlussgewinde		Art.-Nr.	
Connection thread		Art. no.	
Ausführung bitte ergänzen Please complete product details			
	Messing/Brass	= d	
	VA 1.4305/AISI 303	= st	
A	PC	= PC	= TPE
	PVDF	= y	p = TPE-V
M20x1,5	22053	m4x6 *	50
	22053	m6x4 *	50
	22053	m18x2,4 *	50
M25x1,5	22553	m1x2,6	50
	22553	m1x3/1x8	50
	22553	m1x3/1x9	50
	22553	m1x3/2x7,7	50
	22553	m1x3/2x8	50
	22553	m1x3,3/2x3,7	50
	22553	m1x3,5	50
	22553	m1x4	50
	22553	m1x4/1x5	50
	22553	m1x4/2x6/1x7	50
	22553	m1x4/3x5	50
	22553	m1x5	50
	22553	m1x5/1x9	50
	22553	m1x5/2x6	50
	22553	m1x6/1x8	50
	22553	m1x6/1x9,5	50
	22553	m1x6,3/1x6,6	50
	22553	m1x8,5	50
	22553	m2x3,2/2x6	50
	22553	m2x3,3	50
	22553	m2x3,5	50
	22553	m2x3,5/1x5,5	50
	22553	m2x3,5/1x8,5	50
	22553	m2x4	50
	22553	m2x5	50
	22553	m2x5/1x6	50
	22553	m2x6	50
	22553	m2x6/1x7	50
	22553	m2x6/1x8	50
	22553	m2x7	50
	22553	m2x8	50
	22553	m3x1,9/1x2,4/1x7	50
	22553	m3x2,5/1x3,5/1x7	50
22553	m3x3	50	
22553	m3x3/1x6	50	
22553	m3x3,5	50	
22553	m3x4/1x9	50	
22553	m3x5/1x8	50	
22553	m3x6	50	
22553	m3x7	50	
22553	m4x3	50	

Anschlussgewinde		Art.-Nr.	
Connection thread		Art. no.	
Ausführung bitte ergänzen Please complete product details			
	Messing/Brass	= d	
	VA 1.4305/AISI 303	= st	
A	PC	= PC	= TPE
	PVDF	= y	p = TPE-V
M25x1,5	22553	m4x4	50
	22553	m4x5	50
	22553	m4x6	50
M25x1,5	22553	m6x4	50
	22553	m7x2	50
	22553	m7x3	50
	22553	m9x3	50
	22553	m13x2,7	50
	22554	m1x4/1x12 *	25
	22554	m1x4,5/1x12 *	25
	22554	m1x4,5/2x6,5 *	25
	22554	m1x5/1x11,2 *	25
	22554	m1x5,5/1x9 *	25
	22554	m1x5,5/1x10,5 *	25
	22554	m1x5,8/1x6,9/1x8,4 *	25
	22554	m1x6/2x9 *	25
	22554	m1x6,5/1x12 *	25
	22554	m1x6,9/1x7,4/1x8,4 *	25
	22554	m1x7/1x8,5 *	25
	22554	m1x7/1x10,5 *	25
	22554	m1x7,5/1x8,5/1x10 *	25
	22554	m1x8 *	25
	22554	m1x8,5/1x12 *	25
	22554	m1x11,8 *	25
	22554	m2x5/1x5,5 *	25
	22554	m2x6 *	25
	22554	m2x6/2x8 *	25
	22554	m2x6,5/1x9,5 *	25
	22554	m2x7 *	25
	22554	m2x8 *	25
	22554	m2x9 *	25
	22554	m2x10 *	25
	22554	m3x2,5/3x8 *	25
	22554	m3x5 *	25
	22554	m3x7 *	25
	22554	m3x8 *	25
22554	m3x9 *	25	
22554	m4x4,6/3x5,1 *	25	
22554	m4x5 *	25	
22554	m4x5/1x6,5 *	25	
22554	m4x6 *	25	
22554	m4x6,5 *	25	
22554	m4x7,5 *	25	
22554	m4x8 *	25	

* Dichteinsatz kurz = Art.-Nr.: Ek...
* Sealing insert short = art. no.: Ek...

Fortsetzung auf der nächsten Seite
Continued on next page

UNI Mehrfach-Kabelverschraubung

UNI Multiple cable gland

Fortsetzung von vorheriger Seite
Continued from previous page

Anschlussgewinde		Art.-Nr.	
Connection thread		Art. no.	
Ausführung bitte ergänzen Please complete product details			
	Messing/Brass	= d	
	VA 1.4305/AISI 303	= st	
A	PC	= PC	= TPE
	PVDF	= y p	= TPE-V
M25x1,5	22554	m5x5 *	25
	22554	m5x6 *	25
	22554	m6x4 *	25
	22554	m6x5 *	25
	22554	m6x5,5 *	25
	22554	m6x6	25
	22554	m6x6,5 *	25
	22554	m7x4 *	25
	22554	m8x3 *	25
	22554	m8x4 *	25
	22554	m8x5 *	25
	22554	m8x5,5 *	25
	22554	m12x3,5 *	25
	22555	m1x10/1x12 * **	25
	22555	m2x13,9 * **	10
M32x1,5	23254	m1x3,2/2x5/1x6S	25
	23254	m1x3,2/2x6/1x6,1/1x6,8/1x7,3	25
	23254	m1x3,2/2x6/3x7	25
	23254	m1x3,2S/2x5S/1x8,5S	25
	23254	m1x4/1x5/1x13	25
	23254	m1x4,3/1x6/1x8	25
	23254	m1x4,5/1x6/2x6,5	25
	23254	m1x4,5/2x7/1x8	25
	23254	m1x4,5/2x8	25
	23254	m1x4,5/3x7,5	25
	23254	m1x5/1x7/1x12	25
	23254	m1x5/1x9	25
	23254	m1x5,7/1x13	25
	23254	m1x5,7/2x6,3/1x8,5	25
	23254	m1x6/2x9	25
	23254	m1x6,5/1x12	25
	23254	m1x7	25
	23254	m1x7/1x8,5	25
	23254	m1x7/1x10,5	25
	23254	m1x8,5/1x12	25
	23254	m1x9/1x10	25
	23254	m2x3,1/1x6/2x7,7	25
	23254	m2x4,5	25
	23254	m2x4,5/1x13	25
	23254	m2x5,6	25
	23254	m2x6/2x8	25
	23254	m2x7	25
	23254	m2x7/3x7S	25
	23254	m2x7,2/1x10,5	25
	23254	m2x8	25
23254	m2x9	25	
23254	m3x3	25	

Anschlussgewinde		Art.-Nr.	
Connection thread		Art. no.	
Ausführung bitte ergänzen Please complete product details			
	Messing/Brass	= d	
	VA 1.4305/AISI 303	= st	
A	PC	= PC	= TPE
	PVDF	= y p	= TPE-V
M32x1,5	23254	m3x4	25
	23254	m3x5	25
	23254	m3x6	25
	23254	m3x6/1x8	25
	23254	m3x6/2x8	25
	23254	m3x7	25
	23254	m3x8	25
	23254	m3x9	25
	23254	m4x5	25
	23254	m4x5/4x5S	25
	23254	m4x6	25
	23254	m4x6/1x8	25
	23254	m4x6/3x6S	25
	23254	m4x6,5	25
	23254	m4x6,5/1x6,5SB	25
	23254	m4x8	25
	23254	m5x4	25
	23254	m5x5	25
	23254	m5x6	25
	23254	m6x4	25
	23254	m6x4/1x7	25
	23254	m6x5	25
	23254	m6x5,5	25
	23254	m6x6,5	25
	23254	m8x3	25
	23254	m8x4	25
	23254	m8x4/1x4SB	25
	23254	m8x5	25
	23254	m8x5,5	25
	23254	m9x3	25
23254	m10x3	25	
23254	m21x2	25	
23255	m1x3,5/2x8/1x14 *	10	
23255	m1x4/1x6/1x8/2x10 *	10	
23255	m1x4/1x9,3/1x10 *	10	
23255	m1x4/2x8 *	10	
23255	m1x5/3x8,5/1x10,5 *	10	
23255	m1x5,8/1x6,9/1x11 *	10	
23255	m1x5,8/2x11 *	10	
23255	m1x6/1x8,5/1x10,5 *	10	
23255	m1x6,5/1x17 *	10	
23255	m1x6,5/2x11,2 *	10	
23255	m1x7/1x16 *	10	
23255	m1x7/1x9/1x11 *	10	
23255	m1x7/3x9	10	
23255	m1x7,2/1x9,1/1x9,3 *	10	

20400 | T101900

* Dichteinsatz kurz = Art.-Nr.: Ek... ** Ausführung in Edelstahl nicht lieferbar
* Sealing insert short = art. no.: Ek... ** Version made of stainless steel is not available

Fortsetzung auf der nächsten Seite
Continued on next page

UNI Mehrfach-Kabelverschraubung

UNI Multiple cable gland

Fortsetzung von vorheriger Seite
Continued from previous page

Anschlussgewinde Connection thread		Art.-Nr. Art. no.		Ausführung bitte ergänzen Please complete product details	
		Messing/Brass	= d		
		VA 1.4305/AISI 303	= st		
		PC	= PC	= TPE	
		PVDF	= y	p = TPE-V	
A	M32x1,5	23255		m1x8/1x14 *	10
		23255		m1x8/1x9/1x12 *	10
		23255		m1x8/2x11 *	10
		23255		m1x9/1x10 *	10
		23255		m1x9/1x10/1x11 *	10
		23255		m1x9/1x15 *	10
		23255		m1x10/1x12 *	10
		23255		m1x10/1x13 *	10
		23255		m1x10/1x15 *	10
		23255		m1x10,5/1x16 *	10
		23255		m1x11/2x12 *	10
		23255		m2x5/1x8,6/1x12,2 *	10
		23255		m2x5/2x9 *	10
		23255		m2x5,8/1x11 *	10
		23255		m2x6/2x10 *	10
		23255		m2x8,5/1x13,5 *	10
		23255		m2x11 *	10
		23255		m2x12 *	10
		23255		m2x13 *	10
		23255		m2x13,9 *	10
		23255		m3x7 *	10
		23255		m3x9	10
		23255		m3x9 *	10
		23255		m3x11 *	10
		23255		m4x5,5/1x8 *	10
		23255		m4x6,5 *	10
		23255		m4x8 *	10
		23255		m4x9 *	10
		23255		m4x10 *	10
		23255		m4x11 *	10
		23255		m4x9S *	10
		23255		m5x8 *	10
		23255		m5x9 *	10
		23255		m5x9,5 *	10
		23255		m5x10 *	10
		23255		m6x6 *	10
		23255		m6x7,5 *	10
		23255		m6x8 *	10
		23255		m7x7 *	10
		23255		m8x5,5 *	10
	23255		m10x6 *	10	
	23255		m11x5,2 *	10	
	23255		m12x2,8/2x5/2x8 *	10	
	23255		m12x5,3 *	10	
	23255		m24x3 *	10	

* Dichteinsatz kurz = Art.-Nr.: Ek...
* Sealing insert short = art. no.: Ek...

Anschlussgewinde Connection thread		Art.-Nr. Art. no.		Ausführung bitte ergänzen Please complete product details	
		Messing/Brass	= d		
		VA 1.4305/AISI 303	= st		
		PC	= PC	= TPE	
		PVDF	= y	p = TPE-V	
A	M40x1,5	24055		m1x4/1x6/1x8/2x10	10
		24055		m1x4/2x6/4x8	10
		24055		m1x4/2x7/2x9	10
		24055		m1x4/7x7	10
		24055		m1x4,5/4x8	10
		24055		m1x5/2x9/1x13	10
		24055		m1x5/4x9	10
		24055		m1x5,5/1x9	10
		24055		m1x5,8/2x11	10
		24055		m1x6/1x10	10
		24055		m1x6/1x7/1x8/1x11	10
		24055		m1x6/1x8,5/1x10,5	10
		24055		m1x6/2x6,5/2x8	10
		24055		m1x6/2x8/2x11	10
		24055		m1x6/2x9	10
		24055		m1x6,5/1x17	10
		24055		m1x6,5/2x7,5	10
		24055		m1x25,5	10
		24055		m1x6SB/3x6/3x8/1x9,2	10
		24055		m1x7/1x14	10
		24055		m1x7/1x8,5/1x17	10
		24055		m1x7/1x9,5/1x12	10
		24055		m1x7/1x9/1x11	10
		24055		m1x7/2x8,5	10
		24055		m1x7/2x8/2x10	10
		24055		m1x7/3x9	10
		24055		m1x8/2x11	10
		24055		m1x8/2x12	10
		24055		m1x8/2x8,5/1x12	10
		24055		m1x8/2x8,5/1x15	10
		24055		m1x9/1x10/1x11	10
		24055		m1x9/1x15	10
		24055		m1x9,5/1x11,5/1x13,5	10
		24055		m1x9,5/2x13,5	10
		24055		m1x10/1x11,5/1x13	10
		24055		m1x10/1x12/1x13,5	10
		24055		m1x10/1x13	10
		24055		m1x10,5/1x16	10
		24055		m1x10,7/1x13,8	10
		24055		m1x12/1x13	10
	24055		m2x4/2x5/2x7/2x8	10	
	24055		m2x4,8/2x6,3	10	
	24055		m2x4,8/5x6,3	10	
	24055		m2x5/1x8,6/1x12,2	10	

20400 | IT01940

UNI Mehrfach-Kabelverschraubung

UNI Multiple cable gland

Fortsetzung von vorheriger Seite
Continued from previous page

Anschlussgewinde		Art.-Nr.	
Connection thread		Art. no.	
Ausführung bitte ergänzen Please complete product details			
	Messing/Brass	= d	
	VA 1.4305/AISI 303	= st	
A	PC	= PC	= TPE
	PVDF	= y	p = TPE-V
M40x1,5	24055	m2x5,8/1x11	10
	24055	m2x6/1x10,5/1x12	10
	24055	m2x6/1x7,5/2x8,5	10
	24055	m2x6/1x8,5	10
	24055	m2x6/1x8/2x10	10
	24055	m2x6/2x6S/1x7/1x7S/1x10	10
	24055	m2x6,5	10
	24055	m2x6,5/1x10,5	10
	24055	m2x7/1x9	10
	24055	m2x8,5/1x13,5	10
	24055	m2x8,5/2x11,5	10
	24055	m2x9	10
	24055	m2x9/1x13	10
	24055	m2x9/1x15	10
	24055	m2x10	10
	24055	m2x11	10
	24055	m2x13	10
	24055	m3x3/7x4/1x8	10
	24055	m3x3/8x5	10
	24055	m3x3/8x5/1x8	10
	24055	m3x7	10
	24055	m3x7/3x8	10
	24055	m3x9	10
	24055	m3x9/1x11,5	10
	24055	m3x10	10
	24055	m3x11	10
	24055	m3x12	10
	24055	m4x3,5/2x7/1x11	10
	24055	m4x5	10
	24055	m4x5,5	10
	24055	m4x5,5/1x8	10
	24055	m4x5,7/2x10	10
	24055	m4x6/3x8,5	10
	24055	m4x6,5	10
	24055	m4x6,5/4x6,5SB	10
	24055	m4x8	10
	24055	m4x9	10
	24055	m4x10	10
	24055	m4x11	10
	24055	m5x3,5/2x5/1x6/2x6,5	10
	24055	m5x8	10
	24055	m5x9	10
	24055	m5x10	10
	24055	m6x4/3x6/1x8	10
	24055	m6x6	10
	24055	m6x8	10
	24055	m7x4,8	10

Anschlussgewinde		Art.-Nr.	
Connection thread		Art. no.	
Ausführung bitte ergänzen Please complete product details			
	Messing/Brass	= d	
	VA 1.4305/AISI 303	= st	
A	PC	= PC	= TPE
	PVDF	= y	p = TPE-V
M40x1,5	24055	m7x5,5/2x6,5	10
	24055	m7x6/1x11	10
	24055	m7x7	10
	24055	m7x8	10
	24055	m8x5,5	10
	24055	m8x7	10
	24055	m10x6	10
	24055	m11x6	10
	24055	m12x2,8	10
	24055	m12x4/1x8	10
	24055	m12x5,3	10
	24055	m13x3,5/1x9,5	10
	24055	m16x3,5	10
	24055	m17x3,5	10
	24055	m20x3,5	10
	24055	m24x3	10
	24056	m1x4/1x5/2x13 *	10
	24056	m1x4/2x6/4x9 *	10
	24056	m1x4/5x10 *	10
	24056	m1x8,5/1x23	10
	24056	m1x13/1x19 *	10
	24056	m1x14/1x17 *	10
	24056	m1x15/1x17	10
	24056	m2x14 *	10
	24056	m2x15 *	10
	24056	m3x7/4x10 *	10
	24056	m3x13	10
	24056	m3x14,5 *	10
	24056	m4x7 *	10
	24056	m4x10,2 *	10
	24056	m4x13 *	10
	24056	m7x9 *	10
	24056	m8x6/4x8 *	10
	24056	m8x8 *	10
	24056	m8x9 *	10
	24056	m12x6,4 *	10
M50x1,5	25056	m1x3,7/4x4,8/1x5,4/1x6,5/1x10	5
	25056	m1x5/1x9/1x11/1x19	5
	25056	m1x5/2x6,5/1x8,5/1x11	5
	25056	m1x5/3x8/1x8,5/1x9,5	5
	25056	m1x8/2x16	5
	25056	m1x8/4x12,5	5
	25056	m1x9,5/2x13,5	5
	25056	m1x10/3x11,5	5
	25056	m1x11/1x21	5
	25056	m1x11/2x13	5

* Dichteinsatz kurz = Art.-Nr.: Ek...

* Sealing insert short = art. no.: Ek...

Fortsetzung auf der nächsten Seite
Continued on next page

UNI Mehrfach-Kabelverschraubung

UNI Multiple cable gland

Fortsetzung von vorheriger Seite
Continued from previous page

Anschlussgewinde Art.-Nr.		Ausführung bitte ergänzen		
Connection thread Art. no.		Please complete product details		
	Messing/Brass	= d		
	VA 1.4305/AISI 303	= st		
A	PC	= PC	= TPE	
	PVDF	= y	p = TPE-V	
M50x1,5	25056	m1x12,5/1x16,5	5	
	25056	m1x13/1x19	5	
	25056	m1x13/2x16,5	5	
	25056	m1x14/1x17	5	
	25056	m1x20,5	5	
	25056	m1x23	5	
	25056	m1x26	5	
	25056	m1x28	5	
	25056	m1x5SB/4x7/1x14	5	
	25056	m2x8/3x10	5	
	25056	m2x9	5	
	25056	m2x15	5	
	25056	m3x10	5	
	25056	m3x14,5	5	
	25056	m4x7	5	
	25056	m4x9	5	
	25056	m4x10,2	5	
	25056	m4x11,5	5	
	25056	m4x12	5	
	25056	m4x13	5	
	25056	m5x11,5	5	
	25056	m6x10	5	
	25056	m7x9	5	
	25056	m8x7	5	
	25056	m8x8	5	
	25056	m8x9	5	
	25056	m9x7	5	
	25056	m11x8	5	
	25056	m13x7	5	
	25056	m15x5	5	
	25056	m16x6	5	

Anschlussgewinde Art.-Nr.		Ausführung bitte ergänzen		
Connection thread Art. no.		Please complete product details		
	Messing/Brass	= d		
	VA 1.4305/AISI 303	= st		
A	PC	= PC	= TPE	
	PVDF	= y	p = TPE-V	
M50x1,5	25057	m1x3/1x5,2/3x6,7/β	***	5
	25057	m1x7,5/3x11/1x13	***	5
	25057	m1x13,5/3x15,6	***	5
	25057	m2x17	***	5
	25057	m3x6,7/1x11/1x14,5	***	5
	25057	m5x11	***	5
M63x1,5	26358	m1x5,5/1x9/2x15,5	**	5
	26358	m1x5,5/4x15,5	**	5
	26358	m1x9/1x11/3x15,5	**	5
	26358	m1x11/1x32	**	5
	26358	m1x13/3x17	**	5
	26358	m1x30	**	5
	26358	m1x35	**	5
	26358	m2x4,5/2x21	**	5
	26358	m2x11/2x17	**	5
	26358	m2x15	**	5
	26358	m2x16	**	5
	26358	m3x12,5	**	5
	26358	m3x13,5	**	5
	26358	m3x14,5	**	5
	26358	m3x18	**	5
	26358	m4x12	**	5
	26358	m4x16	**	5
	26358	m5x13	**	5
	26358	m6x5,1/1x10/1x10,5/2x13	**	5
	26358	m8x10	**	5
	26358	m8x12	**	5
	26358	m13x3,5/9x5,2	**	5
	26358	m18x7	**	5
	26358	m23x3,3/4x5,1	**	5

* Dichteinsatz kurz = Art.-Nr.: Ek... ** Variante PC nicht lieferbar. Variante y aus Werkstoff POM (Farbe weiß), Temperaturbereich: -40 °C bis +110 °C. Es besteht keine CSA-Zulassung.
* Sealing insert short = art. no.: Ek... ** Variant PC not available. Variant y made of POM (white colour), temperature range: -40 °C up to +110 °C, no CSA approval

i **Farbvarianten für** **PC:** **PCn = schwarz**
PVDF: **ya = blau**
yn = schwarz
Colour variants for **PC:** **PCn = black**
PVDF: **ya = blue**
yn = black

i **Ausführung Polycarbonat/PVDF: Schutzart IP 68 (und Type 4X für PC) ausschließlich in Verbindung mit separat erhältlicher Flachdichtung auf Seite 468**
Version polycarbonate/PVDF: type of protection IP 68 (and Type 4X for PC) only in combination with separately available flat seal ring on page 468

20400 | TTD1900

UNI Silikon Mehrfach-Kabelverschraubung

UNI Silicone Multiple cable gland



Abb. 1
Fig. 1

Abb. 2
Fig. 2

Messing vernickelt, Edelstahl 1.4305, Polycarbonat, PVDF
Metrisches Anschlussgewinde gemäß EN 60423
Schutzart IP 65
Schutzart IP 68 bis 10 bar, wenn Kabel- ϕ = Loch- ϕ
Zugentlastung bis Klasse A, EN 62444

Brass, nickel-plated, stainless steel AISI 303, polycarbonate, PVDF
Metric connection thread EN 60423

Type of protection IP 65

Type of protection IP 68 up to 10 bar, achievable if cable ϕ = hole ϕ
Strain relief up to class A, EN 62444

i	Farbvarianten für	PC:	PCn = schwarz
	Colour variants for	PVDF:	ya = blau
			yn = schwarz
		PC:	PCn = black
		PVDF:	ya = blue
			yn = black

Werkstoff Verschraubungskörper Material gland body	Ausführung/Farbe Version/colour	Bestellschlüssel Art. no. supplement	Werkstoff Dichteinsatz Material sealing insert	Farbe Colour	Temperaturbereich min./max. Temperature range (min./max.)
Messing Brass	Vernickelt Nickel-plated	d	Silikon HT Silicone HT	Schwarz Black	-55 °C / +200 °C
VA 1.4305 AISI 303	Blank	st	Silikon HT Silicone HT	Schwarz Black	-55 °C / +200 °C
PC	Grau Grey	PC	Silikon HT Silicone HT	Schwarz Black	-20 °C / +100 °C
PVDF	Transparent	y	Silikon HT Silicone HT	Schwarz Black	-40 °C / +150 °C



Abb. 3 – Beispiel „2 x 3“
 2 = Anzahl Bohrungen
 3 = Bohrungsdurchmesser in mm
 Fig. 3 – Example „2 x 3“
 2 = number of bores
 3 = bore hole diameter in mm

Anschlussgewinde Connection thread	Art.-Nr. Art. no.	Ausführung bitte ergänzen Please complete product details	
A		Messing/Brass	= d
		VA 1.4305/AISI 303	= st
		PC	= PC
		PVDF	= y
M16x1,5	21650	im2x4HT	50
M20x1,5	22052	im2x5HT	50
	22052	im4x3HT	50
	22052	im4x4HT	50
	22052	im5x2HT	50
M25x1,5	22553	im4x5HT	50
	22553	im4x6HT	50
M32x1,5	23254	im3x7HT	25
	23254	im3x9HT	25
	23254	im4x4HT	25
	23254	im4x6HT	25
	23254	im4x8HT	25
M40x1,5	24055	im2x13HT	10
	24055	im3x11HT	10
	24055	im5x10HT	10
	24055	im5x9HT	10
	24055	im7x7HT	10

52100 | IT01920

UNI Dicht Einsatz geschlossen

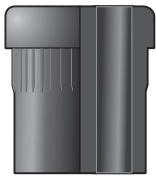
UNI Dicht insert closed



Abb. 1
Fig. 1



Abb. 2
Fig. 2

Messing vernickelt, Edelstahl 1.4305, Polycarbonat, PVDF
Metrisches Anschlussgewinde EN 60423
Mit O-Ring HNBR/Silikon
Schutzart IP 68 bis 10 bar

Brass, nickel-plated, stainless steel AISI 303, polycarbonate, PVDF
Metric connection thread EN 60423
With o-ring HNBR/silicone
Type of protection IP 68 up to 10 bar

i **Maximaler Kabeldurchlass der Druckschraube (F) und maximaler Kabeldurchlass des Doppelnippels (E) siehe Technischer Anhang**
For maximum cable passage of the pressure screw (F) and maximum cable passage of the double nipple (E), see technical appendix.

Werkstoff Verschraubungskörper <i>Material gland body</i>	Ausführung/Farbe <i>Version/colour</i>	Bestellschlüssel <i>Art. no. supplement</i>	Werkstoff Dichteinsatz <i>Material sealing insert</i>	Farbe <i>Colour</i>	Bestellschlüssel <i>Art. no. supplement</i>	Temperaturbereich min./max. <i>Temperature range (min./max.)</i>
Messing <i>Brass</i>	Vernickelt <i>Nickel-plated</i>	d	TPE	Weiß <i>White</i>		-40 °C / +130 °C
Messing <i>Brass</i>	Vernickelt <i>Nickel-plated</i>	d	TPE-V	Natur <i>Natural</i>	p	-40 °C / +135 °C
VA 1.4305 <i>AISI 303</i>	Blank	st	TPE	Weiß <i>White</i>		-40 °C / +130 °C
VA 1.4305 <i>AISI 303</i>	Blank	st	TPE-V	Natur <i>Natural</i>	p	-40 °C / +135 °C
PC	Grau <i>Grey</i>	PC	TPE	Weiß <i>White</i>		-20 °C / +100 °C
PC	Grau <i>Grey</i>	PC	TPE-V	Natur <i>Natural</i>	p	-20 °C / +100 °C
PVDF	Transparent	y	TPE	Weiß <i>White</i>		-40 °C / +130 °C
PVDF	Transparent	y	TPE-V	Natur <i>Natural</i>	p	-40 °C / +135 °C



Abb. 3
Fig. 3

Anschlussgewinde <i>Connection thread</i>	Art.-Nr. <i>Art. no.</i>		
		Ausführung bitte ergänzen <i>Please complete product details</i>	
		Messing/Brass = d	
		VA 1.4305/AISI 303 = st	
		PC = PC	= TPE
		PVDF = y	p = TPE-V
A			
M10x1,0	21049	g * **	50
M10x1,5	21049	g	50
M12x1,5	21249	g **	50
M16x1,5	21650	g	50
M20x1,5	22051	g	50
	22052	g ***	50
M25x1,5	22553	g	50
	22554	g	25
M32x1,5	23254	g	25
	23254	g/21	25
M40x1,5	24055	g	10
	24056	g **	10
M50x1,5	25056	g	5
	25057	g ** ****	5
M63x1,5	26358	g ****	5

* Variante in y und PC nicht erhältlich ** Dichteinsatz kurz = Art.-Nr.: Ek... *** Bei Variante y und PC Dichteinsatz kurz = Art.-Nr.: Ek... **** Variante y und PC aus Werkstoff POM (Farbe weiß); Temperaturbereich: -40 °C bis +110 °C.

* Variant in y and PC not available ** Sealing insert short = art. no.: Ek... *** Variant y and PC sealing insert short = art. no.: Ek... **** Variant y and PC made of POM (white colour), temperature range: -40 °C up to +110 °C

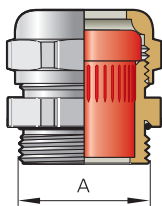
i **Die Anleitung zur Herstellung einer Kabelverschraubung mit eigenem Lochbild aus einem geschlossenen Dichteinsatz finden Sie im Technischer Anhang.**
The instructions for making a cable gland with its own hole pattern from a closed sealing insert can be found in the technical appendix.

i **Ausführung Polycarbonat/PVDF: Schutzart IP 68 ausschließlich in Verbindung mit separat erhältlicher Flachdichtung auf Seite 468**
Version polycarbonate/PVDF: type of protection IP 68 only in combination with separately available flat seal ring on page 468

i **Farbvarianten für**
Colour variants for

PC:	PCn = schwarz
PVDF:	ya = blau
	yn = schwarz
PC:	PCn = black
PVDF:	ya = blue
	yn = black

UNI Stecker-Kabelverschraubung mit geteiltem Dichteinsatz

UNI Connector cable gland with split sealing insert

CE RoHS



Abb. 1
Fig. 1



Abb. 2
Fig. 2

Messing vernickelt, Edelstahl: 1.4305, Polycarbonat, PVDF
Metrisches Anschlussgewinde EN 60423
Schutzart IP 68 bis 10 bar

Brass, nickel-plated, stainless steel: AISI 303, polycarbonate, PVDF
Metric connection thread EN 60423
Type of protection IP 68 up to 10 bar

i **Farbvarianten für** **PC:** **PCn = schwarz**
Colour variants for **PVDF:** **ya = blau**
PC: **yn = schwarz**
PVDF: **PCn = black**
ya = blue
yn = black

Werkstoff Verschraubungskörper Material gland body	Ausführung/Farbe Version/colour	Bestellschlüssel Art. no. supplement	Werkstoff Dichteinsatz Material sealing insert	Farbe Colour	Temperaturbereich min./max. Temperature range (min./max.)
Messing Brass	Vernickelt Nickel-plated	d	TPE-V	Natur Natural	-40 °C / +135 °C
VA 1.4305 AISI 303	Blank	st	TPE-V	Natur Natural	-40 °C / +135 °C
PC	Grau Grey	PC	TPE-V	Natur Natural	-20 °C / +100 °C
PVDF	Transparent	y	TPE-V	Natur Natural	-40 °C / +135 °C

Anschlussgewinde Connection thread	Art.-Nr. Art. no.		
		Ausführung bitte ergänzen Please complete product details	
		Messing/Brass	= d
		VA 1.4305/AISI 303	= st
A		PC	= PC
		PVDF	= y
M40x1,5	24055	pmK	10
	24055	pmK 1/ 5	10
	24055	pmK 1/ 6	10
	24055	pmK 1/ 7	10
	24055	pmK 1/ 8	10
	24055	pmK 1/10	10
	24055	pmK 1/12	10
	24055	pmK 1/13,5	10
	24055	pmK 1/17	10
	24055	pmK 1/21	10
	24055	pmK 1/6-1/ 8,5	10
	24055	pmK 2/6	10
	24055	pmK 2/8	10
	24055	pmK 2/10	10
	24056	pmK *	10
M50x1,5	25056	pmK	5
	25056	pmK 1/ 4,5	5
	25056	pmK 1/ 8	5
	25056	pmK 1/10	5
	25056	pmK 1/11	5
	25056	pmK 1/12	5
	25056	pmK 1/21	5
	25056	pmK 1/23	5
	25056	pmK 1/4,5-1/ 9-1/9,5	5
	25056	pmK 1/5-1/10-1/10,5	5
	25056	pmK 1/8-1/10,5-1/12	5
	25056	pmK 2/6	5
	25056	pmK 2/ 8	5
	25056	pmK 2/8	5

* Dichteinsatz kurz = Art.-Nr.: Ek...
* Sealing insert short = art. no.: Ek...

Fortsetzung auf der nächsten Seite
Continued on next page

UNI Stecker-Kabelverschraubung mit geteiltem Dichteinsatz

UNI Connector cable gland with split sealing insert

Fortsetzung von vorheriger Seite
Continued from previous page

Anschlussgewinde Connection thread	Art.-Nr. Art. no.	Ausführung bitte ergänzen Please complete product details			
		Messing/Brass	= d		
A	VA 1.4305/AISI 303	= st			
	PC	= PC			
	PVDF	= y			
	M50x1,5	25056	pmK 2/11,5	5	
		25056	pmK 2/5,5-1/11,5	5	
		25056	pmK 3/7,2	5	
		25056	pmK 3/7,5	5	
		25056	pmK 3/7,8	5	
		25056	pmK 3/7,8	5	
		25056	pmK 3/10	5	
		25057	pmK * **	5	
		25057	pmK 1/9 * **	5	
		25057	pmK 1/22	5	
25057	pmK 1/26 * **	5			
25057	pmK 1/27 * **	5			

Anschlussgewinde Connection thread	Art.-Nr. Art. no.	Ausführung bitte ergänzen Please complete product details		
		Messing/Brass	= d	
A	VA 1.4305/AISI 303	= st		
	PC	= PC		
	PVDF	= y		
M50x1,5	25057	pmK 1/30 **	5	
	25057	pmK 1/32 * **	5	
	25057	pmK 2/9 * **	5	
M63x1,5	26358	pmK **	5	
	26358	pmK 1/6 **	5	
	26358	pmK 1/6-1/8 **	5	
	26358	pmK 1/8 **	5	
	26358	pmK 1/28 **	5	
	26358	pmK 1/29 **	5	
	26358	pmK 1/32 **	5	
	26358	pmK 2/8 **	5	

* Dichteinsatz kurz = Art.-Nr.: Ek... ** Variante y und PC aus Werkstoff POM (Farbe weiß); Temperaturbereich: -40 °C bis +110 °C.

* Sealing insert short = art. no.: Ek... ** Variant y and PC made of POM (white colour), temperature range: -40 °C up to +110 °C



Das Problem:

Häufig liegen Geräte bereits installiert mit konfektionierten Bauteilen an der Anschlussleitung vor. In der Praxis lassen sich diese Leitungen nur mit geteilten Flanschplatten installieren.

Die Lösung:

Im PFLITSCH-System UNI Stecker sind Dichteinsätze in der Verschraubungsachse geteilt.

- voll, zum Selberbohren mit geeignetem Bohrer
- mit einer Bohrung
- mit mehreren Bohrungen
- Technische Details siehe Seite 477

The problem:

Equipment is frequently installed with assembled components on the connection line. Practically speaking, these lines can only be installed with divided flange plates.

The solution:

In the PFLITSCH UNI Connector system, the sealing inserts are divided on the gland axis.

- Full, for self-drilling with drill
- With one borehole
- With several boreholes
- Technical details see page 477

UNI Dicht ASI-Bus-Kabelverschraubung

UNI Dicht ASI-Bus cable gland

CE RoHS



Abb. 1
Fig. 1



Abb. 2
Fig. 2

Messing vernickelt
Metrisches Anschlussgewinde EN 60423
Mit O-Ring HNBR
Schutzart IP 68 bis 10 bar

Brass, nickel-plated
Metric connection thread EN 60423
With o-ring HNBR
Type of protection IP 68 up to 10 bar

Werkstoff Verschraubungskörper Material gland body	Ausführung/Farbe Version/colour	Werkstoff Dichteinsatz Material sealing insert	Farbe Colour	Temperaturbereich min./max. Temperature range (min./max.)
Messing Brass	Vernickelt Nickel-plated	TPE-V	Natur Natural	-40 °C / +135 °C



Abb. 3
Fig. 3

Anschlussgewinde/-länge Connection thread/length	Art.-Nr. Art. no.	Version ASI Version ASI	Bauhöhe Mounting height	Schlüsselweite Spanner width	
A	D		C	SW x E	
	mm		mm	mm	
M20x1,5	6,5	22052dpm2xASI L	2x links/2x left	21,0	22x24,4
		22052dpm2xASI R	2x rechts/2x right	21,0	22x24,4
	22052dpf4,2ASI10L	links/left	21,0	22x24,4	
	22052dpfm2xASIL/R	links & rechts/left & right	21,0	22x24,4	
	22052dpf4,2ASI10R	rechts/right	21,0	22x24,4	

22500 | IT02500

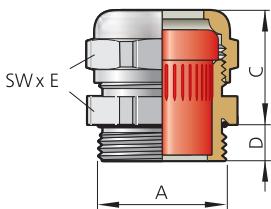

Abb. 4 – ASI-Kabelquerschnitt links = lange Bezugskante
Fig. 4 – ASI cable cross section left = long reference edge

UNI Dicht ASI-Bus-Kabelverschraubung

UNI Dicht ASI-Bus cable gland

CE RoHS

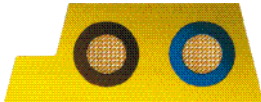

Abb. 1
Fig. 1

Edelstahl: 1.4305
Metrisches Anschlussgewinde EN 60423
Mit O-Ring Silikon
Schutzart IP 68 bis 10 bar

Stainless steel: AISI 303
Metric connection thread EN 60423
With o-ring silicone
Type of protection IP 68 up to 10 bar

Werkstoff Verschraubungskörper Material gland body	Ausführung/Farbe Version/colour	Werkstoff Dichteinsatz Material sealing insert	Farbe Colour	Temperaturbereich min./max. Temperature range (min./max.)
VA 1.4305 AISI 303	Blank	TPE-V	Natur Natural	-40 °C / +135 °C



Abb. 2
Fig. 2

Anschlussgewinde/-länge Connection thread/length	Art.-Nr. Art. no.	Version ASI Version ASI	Bauhöhe Mounting height	Schlüsselweite Spanner width	
A	D		C	SW x E	
	mm		mm	mm	
M20x1,5	6,5	22052stpm2xASI L	2x links/2x left	21,0	22x24,4
		22052stpm2xASI R	2x rechts/2x right	21,0	22x24,4
	22052stpf4,2ASI10L	links/left	21,0	22x24,4	
	22052stpfm2xASIL/R	links & rechts/left & right	21,0	22x24,4	
	22052stpf4,2ASI10R	rechts/right	21,0	22x24,4	

22600 | IT02500

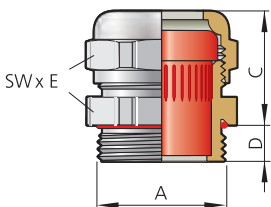

Abb. 3 – ASI-Kabelquerschnitt 2-fach links = lange Bezugskante
Fig. 3 – ASI cable cross section dual left = long reference edge

UNI Dicht ASI-Bus-Kabelverschraubung

UNI Dicht ASI-Bus cable gland

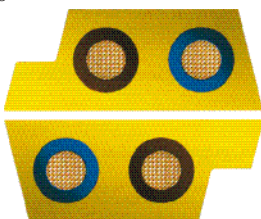

Abb. 1
Fig. 1



Abb. 2
Fig. 2

Polycarbonat, Farbe: grau (RAL 7035), schwarz (RAL 9005)
Metrisches Anschlussgewinde EN 60423
Schutzart IP 68 bis 10 bar

Polycarbonate, colour: grey (RAL 7035), black (RAL 9005)
Metric connection thread EN 60423
Type of protection IP 68 up to 10 bar

i Schutzart IP 68 ausschließlich in Verbindung mit separat erhältlicher Flachdichtung auf Seite 468
Type of protection IP 68 only in combination with separately available flat sealing ring on page 468

Werkstoff Verschraubungskörper Material gland body	Ausführung/Farbe Version/colour	Bestellschlüssel Art. no. supplement	Werkstoff Dichteinsatz Material sealing insert	Farbe Colour	Temperaturbereich min./max. Temperature range (min./max.)
PC	Grau Grey		TPE-V	Natur Natural	-20 °C / +100 °C
PC	Schwarz Black	n	TPE-V	Natur Natural	-20 °C / +100 °C



Abb. 3
Fig. 3



Anschlussgewinde/-länge Connection thread/length		Art.-Nr. Art. no.	Version ASI Version ASI	Bauhöhe Mounting height	Schlüsselweite Spanner width
		Ausführung bitte ergänzen Please complete product details			
A	D mm	Grau/Grey = Schwarz/Black = n		C mm	SW x E mm
M20x1,5	9,0	22052PC	pm2xASI L 2x links/2x left	23,0	24x26,5 50
		22052PC	pm2xASI R 2x rechts/2x right	23,0	24x26,5 50
		22052PC	pf4,2ASI10L links/left	23,0	24x26,5 50
		22052PC	pfm2xASIL/R links & rechts/left & right	23,0	24x26,5 50
		22052PC	pf4,2ASI10R rechts/right	23,0	24x26,5 50

Abb. 4 – ASI-Kabelquerschnitt rechts = lange Bezugskante
Fig. 4 – ASI cable cross section right = long reference edge

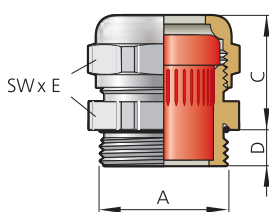
UNI Dicht ASI-Bus-Kabelverschraubung

UNI Dicht ASI-Bus cable gland



Abb. 1
Fig. 1

PVDF, Farbe: transparent, blau (RAL 5015), schwarz (RAL 9005)
Metrisches Anschlussgewinde EN 60423
Schutzart IP 68 bis 10 bar

PVDF, colour: transparent, blue (RAL 5015), black (RAL 9005)
Metric connection thread EN 60423
Type of protection IP 68 up to 10 bar

i Schutzart IP 68 ausschließlich in Verbindung mit separat erhältlicher Flachdichtung auf Seite 468
Type of protection IP 68 only in combination with separately available flat sealing ring on page 468

Werkstoff Verschraubungskörper Material gland body	Ausführung/Farbe Version/colour	Bestellschlüssel Art. no. supplement	Werkstoff Dichteinsatz Material sealing insert	Farbe Colour	Temperaturbereich min./max. Temperature range (min./max.)
PVDF	Transparent		TPE-V	Natur Natural	-40 °C / +135 °C
PVDF	Blau Blue	a	TPE-V	Natur Natural	-40 °C / +135 °C
PVDF	Schwarz Black	n	TPE-V	Natur Natural	-40 °C / +135 °C



Abb. 2
Fig. 2



Anschlussgewinde/-länge Connection thread/length		Art.-Nr. Art. no.	Version ASI Version ASI	Bauhöhe Mounting height	Schlüsselweite Spanner width
		Ausführung bitte ergänzen Please complete product details			
A	D mm	Transparent = Blau/Blue = a Schwarz/Black = n		C mm	SW x E mm
M20x1,5	9,0	22052y	pm2xASI L 2x links/2x left	25,0	24x26,5 50
		22052y	pm2xASI R 2x rechts/2x right	25,0	24x26,5 50
		22052y	pf4,2ASI10L links/left	25,0	24x26,5 50
		22052y	pfm2xASIL/R links & rechts/left & right	25,0	24x26,5 50
		22052y	pf4,2ASI10R rechts/right	25,0	24x26,5 50

Abb. 3 – ASI-Kabelquerschnitt links & rechts = lange Bezugskante
Fig. 3 – ASI cable cross section left & right = long reference edge

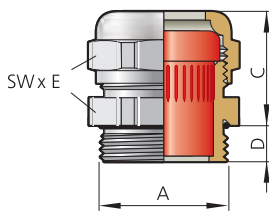
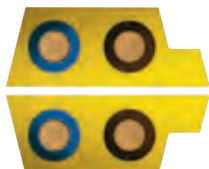
UNI Flach-Kabelverschraubung – Gerundet

UNI Flat cable gland – Rounded



Abb. 1
Fig. 1



Abb. 2
Fig. 2

**Messing vernickelt, Edelstahl 1.4305, Polycarbonat, PVDF
Schutzart IP 65
Form gerundet**

Brass, nickel-plated, stainless steel AISI 303, polycarbonate, PVDF
Type of protection IP 65
Rounded shape

i **Farbvarianten für** **PC:** **PCn = schwarz**
Colour variants for **PVDF:** **ya = blau**
PC: **yn = schwarz**
PVDF: **PCn = black**
ya = blue
yn = black

Werkstoff Verschraubungskörper Material gland body	Ausführung/Farbe Version/colour	Bestellschlüssel Art. no. supplement	Werkstoff Dichteinsatz Material sealing insert	Farbe Colour	Bestellschlüssel Art. no. supplement	Temperaturbereich min./max. Temperature range (min./max.)
Messing Brass	Vernickelt Nickel-plated	d	TPE	Weiß White		-40 °C / +130 °C
Messing Brass	Vernickelt Nickel-plated	d	TPE-V	Natur Natural	p	-40 °C / +135 °C
VA 1.4305 AISI 303	Blank	st	TPE	Weiß White		-40 °C / +130 °C
VA 1.4305 AISI 303	Blank	st	TPE-V	Natur Natural	p	-40 °C / +135 °C
PC	Grau Grey	PC	TPE	Weiß White		-20 °C / +100 °C
PC	Grau Grey	PC	TPE-V	Natur Natural	p	-20 °C / +100 °C
PVDF	Transparent	y	TPE	Weiß White		-40 °C / +130 °C
PVDF	Transparent	y	TPE-V	Natur Natural	p	-40 °C / +135 °C



Abb. 3
Fig. 3

Anschlussgewinde Connection thread	Art.-Nr. Art. no.	Ausführung bitte ergänzen Please complete product details	
		Messing/Brass = d	
		VA 1.4305/AISI 303 = st	
A		PC = PC	= TPE
		PVDF = y	p = TPE-V
M16x1,5	21650	f 3,5g 5,5	50
M20x1,5	22051	f 2,8g10,5	50
	22051	f 3,5g 6	50
	22051	f 3,5g 9	50
	22051	f 4 g 6	50
	22052	f 3 g12 *	50
	22052	f 4,5g10 *	50
	22052	f 5 g11 *	50
	22052	f 5 g12 *	50
M25x1,5	22553	f 5 g16	50
	22553	f 5 g10	50
	22553	f 5 g12	50
	22553	f 5,5g14	50
	22553	f 6 g13	50
	22553	f 7,5g14	50
M32x1,5	23254	f 5 g17	25
	23254	f 7 g18	25

* Bei Variante y und PC Dichteinsatz kurz = Art.-Nr.: Ek...
* Variant y and PC sealing insert short = art. no.: Ek...

UNI Flach-Kabelverschraubung – Gerundet

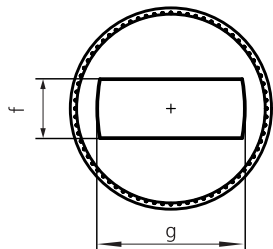
UNI Flat cable gland – Rounded

Fortsetzung von vorheriger Seite
Continued from previous page

Anschlussgewinde Connection thread	Art.-Nr. Art. no.	Ausführung bitte ergänzen Please complete product details		
A	Messing/Brass	= d		
	VA 1.4305/AISI 303	= st		
	PC	= PC	= TPE	
	PVDF	= y	p = TPE-V	
M40x1,5	24055	f 6 g29	10	
	24055	f 8 g25	10	
	24055	f10 g25	10	
	24055	f10 g29	10	
	24055	f13 g28	10	
M50x1,5	25056	f 6 g30	5	
	25056	f 6 g36	5	
	25057	f 6 g38 * **	5	
	25056	f 8 g36	5	
	25056	f11 g34	5	

Anschlussgewinde Connection thread	Art.-Nr. Art. no.	Ausführung bitte ergänzen Please complete product details		
A	Messing/Brass	= d		
	VA 1.4305/AISI 303	= st		
	PC	= PC	= TPE	
	PVDF	= y	p = TPE-V	
M50x1,5	25056	f12 g35	5	
	25057	f10 g38 * **	5	
	25057	f14,5g37 * **	5	
M63x1,5	26358	f 6,5g47 **	5	
	26358	f 9 g43 **	5	
	26358	f14,5g39 **	5	
	26358	f15 g45	5	
M75x1,5	275212	f15 g45 ***	1	
	275212	f18 g54 ***	1	

* Dichteinsatz kurz = Art.-Nr.: Ek... ** Variante PC nicht lieferbar. Variante y aus Werkstoff POM (Farbe weiß), Temperaturbereich: -40 °C bis +110 °C *** Variante in y und PC nicht erhältlich
* Sealing insert short = art. no.: Ek... ** Variant PC not available. Variant y made of POM (white colour), temperature range: -40 °C up to +110 °C *** Variant in y and PC not available

UNI Flach-Kabelverschraubung – Oval

UNI Flat cable gland – Oval



Abb. 1
Fig. 1



Abb. 2
Fig. 2

**Messing vernickelt, Edelstahl 1.4305, Polycarbonat, PVDF
Schutzart IP 65
Form oval**

*Brass, nickel-plated, stainless steel AISI 303, polycarbonate, PVDF
Type of protection IP 65
Oval shape*

i	Farbvarianten für	PC:	PCn = schwarz
	<i>Colour variants for</i>	PVDF:	ya = blau
			yn = schwarz
		<i>PC:</i>	<i>PCn = black</i>
		<i>PVDF:</i>	<i>ya = blue</i>
			<i>yn = black</i>

Werkstoff Verschraubungskörper <i>Material gland body</i>	Ausführung/Farbe <i>Version/colour</i>	Bestellschlüssel <i>Art. no. supplement</i>	Werkstoff Dichteinsatz <i>Material sealing insert</i>	Farbe <i>Colour</i>	Bestellschlüssel <i>Art. no. supplement</i>	Temperaturbereich min./max. <i>Temperature range (min./max.)</i>
PC	Grau <i>Grey</i>	PC	TPE	Weiß <i>White</i>		-20 °C / +100 °C
PC	Grau <i>Grey</i>	PC	TPE-V	Natur <i>Natural</i>	p	-20 °C / +100 °C
Messing <i>Brass</i>	Vernickelt <i>Nickel-plated</i>	d	TPE	Weiß <i>White</i>		-40 °C / +130 °C
Messing <i>Brass</i>	Vernickelt <i>Nickel-plated</i>	d	TPE-V	Natur <i>Natural</i>	p	-40 °C / +135 °C
VA 1.4305 <i>AISI 303</i>	Blank	st	TPE	Weiß <i>White</i>		-40 °C / +130 °C
VA 1.4305 <i>AISI 303</i>	Blank	st	TPE-V	Natur <i>Natural</i>	p	-40 °C / +135 °C
PVDF	Transparent	y	TPE	Weiß <i>White</i>		-40 °C / +130 °C
PVDF	Transparent	y	TPE-V	Natur <i>Natural</i>	p	-40 °C / +135 °C



Abb. 3
Fig. 3

Anschlussgewinde <i>Connection thread</i>	Art.-Nr. <i>Art. no.</i>	Ausführung bitte ergänzen <i>Please complete product details</i>	
A	PC	= PC	
	Messing/Brass	= d	
	VA 1.4305/AISI 303	= st	= TPE
	PVDF	= y	p = TPE-V
M10x1,0	21049	f 1,2v 4/1mm *	50
	21049	f 2 v 4/1mm *	50
M10x1,5	21049	f 1,2v 4/1,5mm *	50
	21049	f 2 v 4/1,5mm *	50
M12x1,5	21249	f 1,2v 4 **	50
	21249	f 2 v 4 **	50
M20x1,5	22051	f 4,5v 7	50
	22052	f 2,5v10 ***	50
	22052	f 5 v 8 ***	50
	22052	f 5 v12 ***	50
	22052	f 6 v 10 ***	50
	22052	f 6 v 9,1 ***	50
M25x1,5	22052	f 8 v10,5 ***	50
	22553	f 5 v10	50
	22553	f 5 v12	50
	22553	f 5 v15	50
	22553	f 5,5v 8,5	50
	22553	f 6 v12,5	50
	22553	f 6 v14	50
	22553	f 6 v15	50
	22553	f 6,5v16,5	50
	22553	f 7 v14	50
22553	f 8 v10,5	50	

* Variante in y und PC nicht erhältlich ** Dichteinsatz kurz = Art.-Nr.: Ek... *** Bei Variante y und PC Dichteinsatz kurz = Art.-Nr.: Ek...
* Variant in y and PC not available ** Sealing insert short = art. no.: Ek... *** Variant y and PC sealing insert short = art. no.: Ek...

Fortsetzung auf der nächsten Seite
Continued on next page

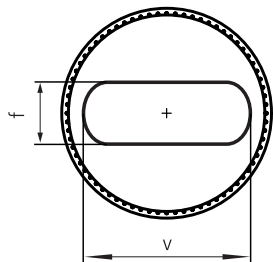
UNI Flach-Kabelverschraubung – Oval

UNI Flat cable gland – Oval

Fortsetzung von vorheriger Seite
Continued from previous page

Anschlussgewinde Connection thread	Art.-Nr. Art. no.	Ausführung bitte ergänzen Please complete product details		
A	Messing/Brass	= d		
	VA 1.4305/AISI 303	= st		
	PC	= PC	= TPE	
	PVDF	= y	p = TPE-V	
M25x1,5	22553	f 8 v14	50	
	22553	f 9 v15	50	
M32x1,5	23254	f 5 v16	25	
	23254	f 7 v16,5	25	
	23254	f 7 v18	25	
	23254	f 7 v20	25	
M40x1,5	24055	f10 v27	10	
	24055	f 4 v23	10	
	24055	f 8 v25	10	

Anschlussgewinde Connection thread	Art.-Nr. Art. no.	Ausführung bitte ergänzen Please complete product details		
A	Messing/Brass	= d		
	VA 1.4305/AISI 303	= st		
	PC	= PC	= TPE	
	PVDF	= y	p = TPE-V	
M40x1,5	24056	f11 v35	10	
M50x1,5	25056	f11 v35	5	
	25056	f13 v30,5	5	
	25056	f 5,5v31	5	
	25056	f 6,5v32	5	
	25057	f 6 v41 * **	5	
	25057	f 9 v38 * **	5	
M63x1,5	26358	f 9 v43 **	5	
M75x1,5	275212	f 9 v55 * ** **	1	

* Dichteinsatz kurz = Art.-Nr.: Ek... ** Variante PC nicht lieferbar. Variante y aus Werkstoff POM (Farbe weiß), Temperaturbereich: -40 °C bis +110 °C *** Nur in Messing lieferbar.
* Sealing insert short = art. no.: Ek... ** Variant PC not available. Variant y made of POM (white colour), temperature range: -40 °C up to +110 °C *** Only available in brass.

234400 | TT01900

UNI Flach-Kabelverschraubung – Eckig

UNI Flat cable gland – Angular



Messing vernickelt, Edelstahl 1.4305, Polycarbonat, PVDF
Schutzart IP 43
Form eckig

Brass, nickel-plated, stainless steel AISI 303, polycarbonate, PVDF
Type of protection IP 43
Angular shape

Abb. 1
Fig. 1

	Farbvarianten für	PC:	PCn = schwarz
	Colour variants for	PVDF:	ya = blau
			yn = schwarz
		PVDF:	PCn = black
			ya = blue
			yn = black

Werkstoff Verschraubungskörper Material gland body	Ausführung/Farbe Version/colour	Bestellschlüssel Art. no. supplement	Werkstoff Dichteinsatz Material sealing insert	Farbe Colour	Bestellschlüssel Art. no. supplement	Temperaturbereich min./max. Temperature range (min./max.)
Messing Brass	Vernickelt Nickel-plated	d	TPE	Weiß White		-40 °C / +130 °C
Messing Brass	Vernickelt Nickel-plated	d	TPE-V	Natur Natural	p	-40 °C / +135 °C
VA 1.4305 AISI 303	Blank	st	TPE	Weiß White		-40 °C / +130 °C
VA 1.4305 AISI 303	Blank	st	TPE-V	Natur Natural	p	-40 °C / +135 °C
PC	Grau Grey	PC	TPE	Weiß White		-20 °C / +100 °C
PC	Grau Grey	PC	TPE-V	Natur Natural	p	-20 °C / +100 °C
PVDF	Transparent	y	TPE	Weiß White		-40 °C / +130 °C
PVDF	Transparent	y	TPE-V	Natur Natural	p	-40 °C / +135 °C



Abb. 2
Fig. 2

Anschlussgewinde Connection thread	Art.-Nr. Art. no.	Ausführung bitte ergänzen Please complete product details	
A	Messing/Brass	= d	
	VA 1.4305/AISI 303	= st	
	PC	= PC	= TPE
	PVDF	= y	p = TPE-V
M25x1,5	22553	f 8 e12	50
M32x1,5	23254	f 4 e15	25
M40x1,5	24055	f 6 e26	10
M50x1,5	25057	f 6 e39 * **	5

23410 | ITD1900

* Dichteinsatz kurz = Art.-Nr.: Ek... ** Variante PC nicht lieferbar. Variante y aus Werkstoff POM (Farbe weiß), Temperaturbereich: -40 °C bis +110 °C
 * Sealing insert short = art. no.: Ek... ** Variant PC not available. Variant y made of POM (white colour), temperature range: -40 °C up to +110 °C

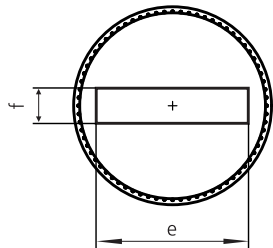
Zugentlastung und Biegeschutz – metrisch

*Strain relief
and bending protection – metric*



Abb. 1 – UNI Biegeschutz Dicht-Kabelverschraubung
Fig. 1 – UNI Dicht Bending protection cable gland

Abb. 2 – UNI Zug Dicht-Kabelverschraubung
Fig. 2 – UNI Dicht Strain relief cable gland

Abb. 3 – UNI Flex Dicht
Fig. 3 – UNI Flex Dicht

Erhöhte Zugentlastung inklusive

PFLITSCH-Kabelverschraubungen verfügen bereits serienmäßig über Zugentlastungswerte, die der Norm EN 62444, Klasse A, entsprechen. Noch mehr Sicherheit durch erhöhte Zugentlastung bringen die Baureihen UNI Zug, UNI Klemm und UNI Biege Zug aus dem UNI Dicht-Baukasten. Ebenso sind hier Lösungen für einen umfassenden Biegeschutz zu finden.

UNI Zug mit integrierten Spannbacken

Bei der UNI Zug bestehen die Dichteinsätze aus TPE und TPE-V mit integrierten Klemmkörpern aus PA, die wie ein Spannfutter wirken und Zugkräfte bis über 200 N am Kabel vibrationsfest abfangen.

UNI Klemm mit Bügelschellen

Mit zwei Bügelschellen an der Druckschraube lassen sich bei der UNI Klemm Kabel sicher fixieren. Dabei werden Zugkräfte bis über 500 N abgefangen. UNI Klemm entspricht damit der in der Norm EN 62444 geforderten „Ausführung B“.

UNI Biegeschutz Dicht-Kabelverschraubungen

Diese Kabelverschraubungen verhindern durch eine lange, konische Biegeschutztülle aus TPE-V, dass die Kabel an der Biegestelle beschädigt werden. Die Tülle liegt fest am Kabel an und hält äußere Einflüsse, wie z. B. UV-Strahlung und aggressive Medien, von dem unter Biegestress stehenden Kabelabschnitt fern. Zur einfacheren Montage kann die Tülle aufgeweitet werden, um das Kabel leichter durchschieben zu können.

UNI Biege Zug – die perfekte Kombination

Eine interessante Variante ist die UNI Biege Zug-Kabelverschraubung. Ihr Dichteinsatz ist mit Spannbacken für eine vibrationsfeste Zugentlastung ausgestattet und verfügt über eine angespritzte große Tülle, die das Kabel sicher vor dem Abknicken schützt, beispielsweise bei Industrie-Steckverbindern.

UNI Flex für noch mehr Biegeschutz

Mit einer speziell gewendelten Edelstahlfeder mit progressiver Kennlinie optimiert die UNI Flex die Verteilung der Biegebeanspruchungen des Kabels. Auf etwa 10 cm Länge fängt diese Kabelverschraubung selbst hohe dynamische Biegebelastungen am Kabeleintritt sicher ab.

Increased strain relief included

PFLITSCH cable glands are produced as standard with strain relief values that correspond to the EN 62444 class A standard. The models UNI Strain relief, UNI Clamping and UNI Bending Strain relief from the UNI Dicht modular range provide even more safety with increased strain relief.

UNI Strain relief with integrated clamping jaws

With UNI Strain relief, the sealing inserts made of TPE and TPE-V are fitted with integrated clamping bodies made of PA which act like clamping jaws. Tractive forces on the cable are intercepted up to 200 N with vibration resistance.

UNI Clamping with clips

With two clips on the pressure screw, cables can be securely fixated using UNI Clamping. Tractive forces of up to over 500 N can be absorbed here. UNI Clamping is thus consistent with "Execution B" in the EN 62444 standard.

UNI Bending protection cable glands

These cable glands prevent – through a long, conical bending protection socket made of TPE-V – cables from being damaged at the bending point. The socket fits rigidly to the cable and keeps external influences, such as UV radiation and aggressive media, away from the section of cable which is under bending strain. The socket can be widened for simpler mounting so the cable can be pushed through more easily.

UNI Bending Strain relief – the perfect combination

An interesting variant is the UNI Bending Strain relief cable gland. Its sealing insert is fitted with clamping jaws and is equipped with an extruded large nozzle, reliably protecting the cable against kinking, for example, in industrial plug connectors.

UNI Flex for even more bending protection

UNI Flex optimises distribution of the cable's bending loads with a specially coiled stainless steel spring with progressive characteristic. This cable gland will safely absorb even high dynamic bending loads at the cable entry over a length of approx. 10 cm.

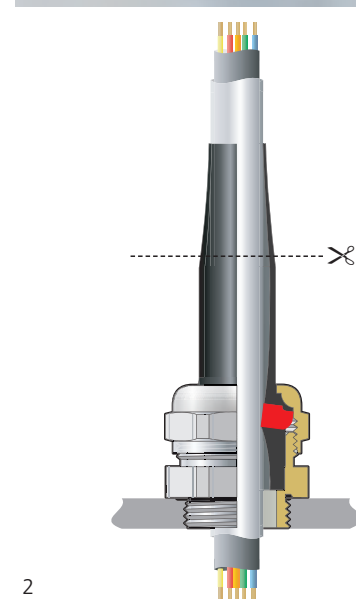

2

✂ Durch Kürzen des Konus wird die Tülle an den jeweiligen Kabelquerschnitt angepasst.

✂ Shortening the cone enables the socket to be adapted to the particular cable cross section concerned.

Abb. 1 – UNI Klemm Dicht-Kabelverschraubung
Fig. 1 – UNI Clamping Dicht cable gland

Abb. 2 – Schema UNI Biege Zug
Fig. 2 – Section of the UNI Bending Strain relief

UNI Zug Dicht-Kabelverschraubung

UNI Dicht Strain relief cable gland



Abb. 1
Fig. 1



Abb. 2
Fig. 2

Messing vernickelt
Metrisches Anschlussgewinde EN 60423
Mit O-Ring HNBR
Schutzart IP 54

Brass, nickel-plated
Metric connection thread EN 60423
With o-ring HNBR
Type of protection IP 54

i Auf Anfrage erhältlich: Anschlussgewinde 15 mm und Ausführung in Edelstahl
Available on request: connection thread 15 mm and stainless steel version

Werkstoff Verschraubungskörper Material gland body	Ausführung/Farbe Version/colour	Werkstoff Dichteinsatz Material sealing insert	Farbe Colour	Bestellschlüssel Art. no. supplement	Temperaturbereich min./max. Temperature range (min./max.)
Messing Brass	Vernickelt Nickel-plated	TPE	s. FC s. CC		-20 °C / +100 °C
Messing Brass	Vernickelt Nickel-plated	TPE-V	Natur Natural	p	-20 °C / +100 °C



Abb. 3
Fig. 3

Anschlussgewinde/-länge Connection thread/length		Art.-Nr. Art. no.	Dichtbereich Sealing range	Bauhöhe Mounting height	Schlüsselweite Spanner width
A	D mm	Ausführung bitte ergänzen Please complete product details		C mm	SW₁ x E₁ / SW₂ x E₂ mm
		TPE =	max./min. ø mm		
		TPE-V = p			
M10x1,0	5,0	21049d	z 7/1mm	19,0	14x15,5 50
M10x1,5	5,0	21049d	z 7/1,5mm	19,0	14x15,5 50
M12x1,5	5,0	21249d	z 7	20,0	14x15,5 50
		21250d	z 9 *	21,0	17x18,9 50
M16x1,5	6,0	21650d	z 7	20,0	18x20/17x18,9 50
		21650d	z 9	20,0	18x20/17x18,9 50
		21651d	z 11 *	21,0	20x22,2 50
		21652d	z 13 *	21,0	22x24,4 50
M20x1,5	6,5	22052d	z 9	21,0	22x24,4 50
		22052d	z 11	21,0	22x24,4 50
		22052d	z 13	21,0	22x24,4 50
		22053d	z 16 *	21,0	24x26,7 50
		22054d	z 18 *	24,0	30x33,5 25
		22054d	z 20 *	24,0	30x33,5 25
M25x1,5	7,5	22553d	z 11	21,0	28x31,2/24x26,7 50
		22553d	z 13	21,0	28x31,2/24x26,7 50
		22553d	z 16	21,0	28x31,2/24x26,7 50
		22554d	z 18 *	25,0	30x33,5 25
		22554d	z 20 *	25,0	30x33,5 25
		22555d	z 25 *	25,0	40x43,5 10
		22555d	z 28 *	25,0	40x43,5 10
M32x1,5	8,0	23254d	z 13	26,0	35x38,5/30x33,5 25
		23254d	z 16	26,0	35x38,5/30x33,5 25
		23254d	z 18	26,0	35x38,5/30x33,5 25
		23254d	z 20	26,0	35x38,5/30x33,5 25
		23255d	z 25 *	29,0	40x43,5 25
		23255d	z 28 *	29,0	40x43,5 10
M40x1,5	8,0	24055d	z 20	29,0	43x47,3/40x43,5 10
		24055d	z 25	29,0	43x47,3/40x43,5 10
		24055d	z 28	29,0	43x47,3/40x43,5 10
M40x1,5	9,0	24056d	z 32 *	28,0	50x54 10
		24056d	z 36 *	28,0	50x54 10
M50x1,5	10,0	25056d	z 32	30,0	54x58/50x54 5
		25056d	z 36	30,0	54x58/50x54 5
		25057d	z 40 *	30,0	57x61 5
M63x1,5	10,0	26358d	z 44	30,0	68x74/64x69 5

* Dichteinsatz kurz = Art.-Nr.: Ek...
* Sealing insert short = art. no.: Ek...

i Passende Gegenmuttern ab Seite 442
Corresponding locknuts see from page 442

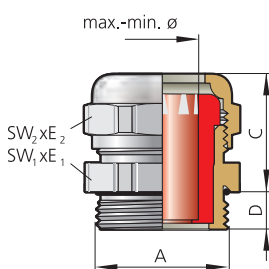
UNI Zug Dicht-Kabelverschraubung

UNI Dicht Strain relief cable gland



Abb. 1
Fig. 1

Abb. 2
Fig. 2

Polycarbonat, Farbe: grau (RAL 7035), schwarz (RAL 9005)
Metrisches Anschlussgewinde EN 60423
Schutzart IP 54

Polycarbonate, colour: grey (RAL 7035), black (RAL 9005)
Metric connection thread EN 60423
Type of protection IP 54

i **Type 4X ausschließlich in Verbindung mit Flachdichtung auf Seite 468**
Type 4X only in combination with flat sealing ring on page 468

Werkstoff Verschraubungskörper Material gland body	Ausführung/Farbe Version/colour	Bestellschlüssel Art. no. supplement	Werkstoff Dichteinsatz Material sealing insert	Farbe Colour	Bestellschlüssel Art. no. supplement	Temperaturbereich min./max. Temperature range (min./max.)
PC	Grau Grey		TPE	s. FC s. CC		-20 °C / +100 °C
PC	Grau Grey		TPE-V	Natur Natural	p	-20 °C / +100 °C
PC	Schwarz Black	n	TPE	s. FC s. CC		-20 °C / +100 °C
PC	Schwarz Black	n	TPE-V	Natur Natural	p	-20 °C / +100 °C



Abb. 3
Fig. 3

Anschlussgewinde/-länge Connection thread/length		Art.-Nr. Art. no.	Dichtbereich Sealing range	Bauhöhe Mounting height	Schlüsselweite Spanner width
Ausführung bitte ergänzen Please complete product details					
A	D mm	Grau/Grey = Schwarz/Black = n p	= TPE = TPE-V	max./min. ø mm	C mm
M12x1,5	8,0	21249PC 21250PC	z 7 z 9 *	6,5 – 4,0 9,0 – 5,5	22,0
M16x1,5	9,0	21650PC 21650PC 21651PC	z 7 z 9 z11 *	6,5 – 4,0 9,0 – 5,5 10,0 – 6,0	22,0 22,0 23,0
M20x1,5	9,0	22052PC 22052PC 22052PC 22053PC	z 9 * z11 * z13 * z16 *	9,0 – 5,5 10,0 – 6,0 12,0 – 8,0 15,0 – 12,0	23,0 23,0 23,0 24,0
M25x1,5	9,0	22553PC 22553PC 22553PC	z11 z13 z16	10,0 – 6,0 12,0 – 8,0 15,0 – 12,0	24,0 24,0 24,0
M25x1,5	11,0	22554PC 22554PC 22555PC 22555PC	z18 * z20 * z25 * z28 *	17,0 – 14,0 20,0 – 16,0 24,0 – 20,0 27,0 – 23,0	29,0 29,0 29,0 29,0
M32x1,5	11,0	23254PC 23254PC 23254PC 23254PC 23255PC 23255PC	z13 z16 z18 z20 z25 * z28 *	12,0 – 8,0 15,0 – 12,0 17,0 – 14,0 20,0 – 16,0 24,0 – 20,0 27,0 – 23,0	29,0 29,0 29,0 29,0 32,0 32,0
M40x1,5	11,5	24055PC 24055PC 24055PC	z20 z25 z28	20,0 – 16,0 24,0 – 20,0 27,0 – 23,0	33,0 33,0 33,0
M40x1,5	13,0	24056PC 24056PC	z32 z36	31,5 – 27,0 36,0 – 32,0	35,0 35,0
M50x1,5	14,0	25056PC 25056PC	z32 z36	31,5 – 27,0 36,0 – 32,0	34,0 34,0

* Dichteinsatz kurz = Art.-Nr.: Ek...
* Sealing insert short = art. no.: Ek...

i **Passende Gegenmuttern ab Seite 442**
Corresponding locknuts see from page 442

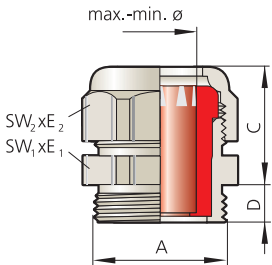
UNI Zug Dicht-Kabelverschraubung

UNI Dicht Strain relief cable gland



Abb. 1
Fig. 1

Abb. 2
Fig. 2

PVDF, Farben: transparent, blau (RAL 5015), schwarz (RAL 9005)
Metrisches Anschlussgewinde EN 60423
Schutzart IP 54

PVDF, colours: transparent, blue (RAL 5015), black (RAL 9005)
Metric connection thread EN 60423
Type of protection IP 54

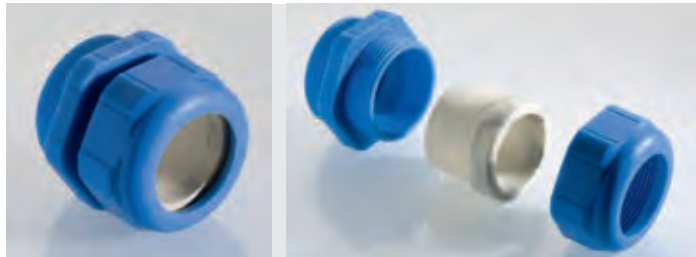
i Anschlussgewinde mit 15 mm Länge auf Anfrage
Long connection thread 15 mm on request

Werkstoff Verschraubungskörper <i>Material gland body</i>	Ausführung/Farbe <i>Version/colour</i>	Bestellschlüssel <i>Art. no. supplement</i>	Werkstoff Dichteinsatz <i>Material sealing insert</i>	Farbe <i>Colour</i>	Bestellschlüssel <i>Art. no. supplement</i>	Temperaturbereich min./max. <i>Temperature range (min./max.)</i>
PVDF	Transparent		TPE	s. FC s. CC		-20 °C / +100 °C
PVDF	Transparent		TPE-V	Natur <i>Natural</i>	p	-20 °C / +100 °C
PVDF	Blau <i>Blue</i>	a	TPE	s. FC s. CC		-20 °C / +100 °C
PVDF	Blau <i>Blue</i>	a	TPE-V	Natur <i>Natural</i>	p	-20 °C / +100 °C
PVDF	Schwarz <i>Black</i>	n	TPE	s. FC s. CC		-20 °C / +100 °C
PVDF	Schwarz <i>Black</i>	n	TPE-V	Natur <i>Natural</i>	p	-20 °C / +100 °C





Abb. 3
Fig. 3

Anschlussgewinde/-länge <i>Connection thread/length</i>		Art.-Nr. <i>Art. no.</i>	Dichtbereich <i>Sealing range</i>	Bauhöhe <i>Mounting height</i>	Schlüsselweite <i>Spanner width</i>
Ausführung bitte ergänzen <i>Please complete product details</i>					
		Transparent =	a = TPE		
		Blau/Blue =	n = TPE-V		
		Schwarz/Black =	p = TPE-V		
A	D mm		max./min. ø mm	C mm	SW ₁ x E ₁ /SW ₂ x E ₂ mm
M12x1,5	8,0	21249y	z 7 *	6,5– 4,0	15x16,5
M16x1,5	8,5	21651y	z11 *	10,0– 6,0	22x24,5
M16x1,5	9,0	21650y	z 7	6,5– 4,0	19x21,2
		21650y	z 9	9,0– 5,5	19x21,2
M20x1,5	9,0	22052y	z 9 *	9,0– 5,5	24x26,5
		22052y	z11 *	10,0– 6,0	24x26,5
		22052y	z13 *	12,0– 8,0	24x26,5
		22053y	z16 *	15,0– 12,0	27x29,5
M20x1,5	11,0	22054y	z18 *	17,0– 14,0	33x36,5
		22054y	z20 *	20,0– 16,0	33x36,5
M25x1,5	9,0	22553y	z11	10,0– 6,0	29x31,5/27x29,5
		22553y	z13	12,0– 8,0	29x31,5/27x29,5
		22553y	z16	15,0– 12,0	29x31,5/27x29,5
M25x1,5	11,0	22554y	z18 *	17,0– 14,0	33x36,5
		22554y	z20 *	20,0– 16,0	33x36,5
		22555y	z25 *	24,0– 20,0	43x46
		22555y	z28 *	27,0– 23,0	43x46
M32x1,5	11,0	23254y	z13	12,0– 8,0	38x42/33x36,5
		23254y	z16	15,0– 12,0	38x42/33x36,5
		23254y	z18	17,0– 14,0	38x42/33x36,5
		23254y	z20	20,0– 16,0	38x42/33x36,5
		23255y	z25 *	24,0– 20,0	43x46
		23255y	z28 *	27,0– 23,0	43x46
M40x1,5	11,5	24055y	z20	20,0– 16,0	46x50/43x46,5
		24055y	z25	24,0– 20,0	46x50/43x46,5
		24055y	z28	27,0– 23,0	46x50/43x46,5

* Dichteinsatz kurz = Art.-Nr.: Ek...
* Sealing insert short = art. no.: Ek...

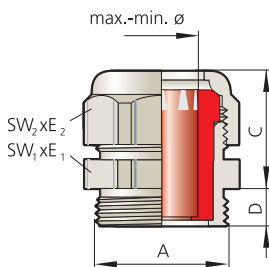
12660 | TT06500

UNI Zug Dicht-Kabelverschraubung
UNI Dicht Strain relief cable gland
 Fortsetzung von vorheriger Seite
Continued from previous page

Anschlussgewinde/-länge Connection thread/length		Art.-Nr. Art. no.	Dichtbereich Sealing range	Bauhöhe Mounting height	Schlüsselweite Spanner width		
		Ausführung bitte ergänzen Please complete product details					
A	D mm	Transparent =	max./min. ø mm	C mm	SW ₁ x E ₁ /SW ₂ x E ₂ mm		
		Blau/Blue = a = TPE					
		Schwarz/Black = n p = TPE-V					
M40x1,5	13,0	24056y	z32 *	31,5–27,0	35,0	53x57	5
		24056y	z36 *	36,0–32,0	35,0	53x57	5
M50x1,5	13,0	25056y	z32	31,5–27,0	35,0	56x61/53x57	5
		25056y	z36	36,0–32,0	35,0	56x61/53x57	5
M50x1,5	14,0	25057y	z40 * **	40,0–36,0	38,0	60x65	5
M63x1,5	14,0	26358y	z44 * **	44,0–39,0	41,0	68x73/65x70	5

* Dichteinsatz kurz = Art.-Nr.: Ek... ** Variante y aus Werkstoff POM (Farbe weiß); Temperaturbereich: -40 °C bis +110 °C
* Sealing insert short = art. no.: Ek... ** Variant y made of POM (white colour), temperature range: -40 °C up to +110 °C

12660 | TT0950

UNI Klemm Dicht-Kabelverschraubung

UNI Clamping Dicht cable gland



Abb. 1
Fig. 1



Abb. 2
Fig. 2

Messing vernickelt
Metrisches Gewinde EN 60423
Mit O-Ring HNBR
Schutzart IP 68

Brass, nickel-plated
Metric connection thread EN 60423
With o-ring HNBR
Type of protection IP 68

i Anschlussgewinde mit 15 mm Länge auf Anfrage
Long connection thread 15 mm on request

Werkstoff Verschraubungskörper Material gland body	Ausführung/Farbe Version/colour	Werkstoff Dichteinsatz Material sealing insert	Farbe Colour	Bestellschlüssel Art. no. supplement	Temperaturbereich min./max. Temperature range (min./max.)
Messing Brass	Vernickelt Nickel-plated	TPE	s. FC s. CC		-40 °C / +130 °C
Messing Brass	Vernickelt Nickel-plated	TPE-V	Natur Natural	p	-40 °C / +135 °C
Messing Brass	Vernickelt Nickel-plated	Silikon HT Silicone HT	Schwarz Black	H	-55 °C / +200 °C



Abb. 3
Fig. 3

Anschlussgewinde/-länge Connection thread/length		Art.-Nr. Art. no.	Dichtbereich Sealing range	Bauhöhe Mounting height	Schlüsselweite Spanner width		
Ausführung bitte ergänzen Please complete product details							
A	D mm	TPE =	max./min. ø mm	C mm	SW ₁ x E ₁ / SW ₂ x E ₂		
		TPE-V = p					
		Silikon HT/Silicone HT = H					
M12x1,5	5,0	21250d	8zu *	8,0 – 6,0	39,0	17x18,9	50
		21250d	9zu *	9,5 – 6,5	39,0	17x18,9	50
M16x1,5	6,0	21650d	8zu	8,0 – 6,0	39,0	18x20/17x18,9	50
		21650d	9zu	9,5 – 6,5	39,0	18x20/17x18,9	50
		21651d	11zu *	10,5 – 7,0	39,0	20x22,2	50
		21652d	13zu *	13,0 – 9,0	39,0	22x24,4	50
M20x1,5	6,5	22052d	9zu	9,5 – 7,0	39,0	22x24,4	50
		22052d	11zu	10,5 – 7,0	39,0	22x24,4	50
		22052d	13zu	13,0 – 9,0	39,0	22x24,4	50
		22053d	16zu *	15,5 – 11,5	41,0	24x26,7	50
M25x1,5	7,5	22553d	9zu	9,5 – 7,0	41,0	28x31,2/24x26,7	50
		22553d	11zu	10,5 – 7,0	41,0	28x31,2/24x26,7	50
		22553d	13zu	13,0 – 9,0	41,0	28x31,2/24x26,7	50
		22553d	16zu	15,5 – 11,5	41,0	28x31,2/24x26,7	25
		22554d	18zu *	18,0 – 14,0	48,0	30x33,5	25
		22554d	20zu *	20,5 – 17,0	48,0	30x33,5	25
M32x1,5	8,0	23254d	13zu	13,0 – 10,0	48,0	35x38,5/30x33,5	25
		23254d	16zu	15,5 – 11,5	48,0	35x38,5/30x33,5	25
		23254d	18zu	18,0 – 14,0	48,0	35x38,5/30x33,5	25
		23254d	20zu	20,5 – 17,0	48,0	35x38,5/30x33,5	25
		23255d	25zu *	25,0 – 20,0	52,0	40x43,5	10
M40x1,5	8,0	24055d	18zu	18,0 – 14,0	51,0	43x47,3/40x43,5	10
		24055d	20zu	20,5 – 17,0	51,0	43x47,3/40x43,5	10
		24055d	25zu	25,0 – 20,0	51,0	43x47,3/40x43,5	10
		24055d	28zu	28,0 – 24,0	51,0	43x47,3/40x43,5	10
M40x1,5	9,0	24056d	32zu *	32,0 – 27,0	52,0	50x54	5

* Dichteinsatz kurz = Art.-Nr.: Ek...
* Sealing insert short = art. no.: Ek...

1311001 | IT00400

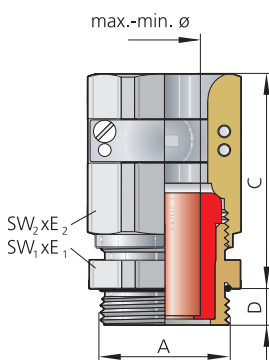
UNI Klemm Dicht-Kabelverschraubung

UNI Clamping Dicht cable gland

Fortsetzung von vorheriger Seite
Continued from previous page

Anschlussgewinde/-länge Connection thread/length		Art.-Nr. Art. no.	Dichtbereich Sealing range	Bauhöhe Mounting height	Schlüsselweite Spanner width		
Ausführung bitte ergänzen Please complete product details							
A	D mm	TPE =	max./min. ø mm	C mm	SW ₁ x E ₁ /SW ₂ x E ₂ mm		
		TPE-V = p					
		Silikon HT/Silicone HT = H					
M50x1,5	10,0	25056d	32zu	32,0 – 27,0	52,0	54x58/50x54	5
		25056d	34zu	34,0 – 29,0	52,0	54x58/50x54	5
		25056d	36zu	36,0 – 32,0	52,0	54x58/50x54	5
M63x1,5	10,0	26358d	44zu *	44,0 – 39,0	54,0	68x74/64x69	5
M75x1,5	15,0	275212d	47zu *	47,0 – 42,0	63,0	81x87	1
		275212d	52zu *	52,0 – 45,0	63,0	81x87	1
		275212d	55zu *	55,0 – 51,0	63,0	81x87	1
		275212d	58zu *	58,0 – 54,0	63,0	81x87	1
M80x2	15,0	280300d	57zu *	57,0 – 52,0	77,0	95x102	1
		280300d	64zu *	64,0 – 58,0	77,0	95x102	1
		280300d	70zu *	70,0 – 63,0	77,0	95x102	1

* Dichteinsatz aus Silikon HT nicht lieferbar
* Sealing insert silicone HT not available

i Passende Gegenmuttern ab Seite 442
Corresponding locknuts see from page 442

131100 | IT000400

UNI Biegeschutz Dicht-Kabelverschraubung

UNI Dicht Bending protection cable gland



Abb. 1
Fig. 1



Abb. 2
Fig. 2

Messing vernickelt
Metrisches Anschlussgewinde EN 60423
Mit O-Ring HNBR
Schutzart IP 68 bis 10 bar

Brass, nickel-plated
Metric connection thread EN 60423
With o-ring HNBR
Type of protection IP 68 up to 10 bar

i Anschlussgewinde mit 15 mm Länge auf Anfrage
Long connection thread 15 mm on request

Werkstoff Verschraubungskörper Material gland body	Ausführung/Farbe Version/colour	Werkstoff Dichteinsatz Material sealing insert	Farbe Colour	Temperaturbereich min./max. Temperature range (min./max.)
Messing Brass	Vernickelt (v) Nickel-plated (n)	TPE-V	Schwarz Black	-40 °C / +135 °C



Abb. 3
Fig. 3

Anschlussgewinde/-länge Connection thread/length		Art.-Nr. Art. no.	Dichtbereich Sealing range	Bauhöhe Mounting height	Schlüsselweite Spanner width	
A	D mm		max./min. ø mm	C mm	SW ₁ x E ₁ /SW ₂ x E ₂ mm	
M12x1,5	5,0	21249dLp 4/V2	4,0 – 2,5	53,0	14x15,5	50
		21249dLp 5/V2	5,0 – 3,5	53,0	14x15,5	50
		21249dLp 6/V2	6,0 – 4,5	53,0	14x15,5	50
		21249dLp 6,5/V2	6,5 – 5,5	53,0	14x15,5	50
M16x1,5	6,0	21650dLp 5,5/V2	5,5 – 4,0	66,0	18x20/17x18,9	50
		21650dLp 6/V2	6,0 – 5,0	66,0	18x20/17x18,9	50
		21650dLp 7,5/V2	7,5 – 5,5	66,0	18x20/17x18,9	50
M20x1,5	6,5	22051dLp 5,5/V2	5,5 – 4,0	66,0	22x24,4/20x22,2	50
		22051dLp 6,5/V2	6,5 – 5,0	66,0	22x24,4/20x22,2	50
		22052dLp 6,5/V2	6,5 – 5,0	77,0	22x24,4/20x22,2	50
		22052dLp 7,5/V2	7,5 – 6,0	77,0	22x24,4	50
		22051dLp 8/V2	8,0 – 6,0	66,0	22x24,4/20x22,2	50
		22052dLp 8,5/V2	8,5 – 7,0	77,0	22x24,4	50
		22051dLp 9,5/V2	9,5 – 7,5	66,0	22x24,4/20x22,2	50
		22052dLp 10,5/V2	10,5 – 8,0	77,0	22x24,4	50
M25x1,5	7,5	22553dLp 8/V2	8,0 – 6,5	83,0	28x31,2/24x26,7	25
		22553dLp 9,5/V2	9,5 – 7,5	83,0	28x31,2/24x26,7	25
		22553dLp 11/V2	11,0 – 9,0	83,0	28x31,2/24x26,7	25
		22553dLp 13/V2	13,0 – 10,5	83,0	28x31,2/24x26,7	25
M32x1,5	8,0	23254dLp 10/V2	10,0 – 8,0	80,0	35x38,5/30x33,5	10
		23254dLp 11,5/V2	11,5 – 9,5	80,0	35x38,5/30x33,5	10
		23254dLp 13,5/V2	13,5 – 11,0	80,0	35x38,5/30x33,5	10
		23254dLp 15,5/V2	15,5 – 13,0	80,0	35x38,5/30x33,5	10
		23254dLp 17,5/V2	17,5 – 15,0	80,0	35x38,5/30x33,5	10
M40x1,5	8,0	24055dLp 19,5/V2	19,5 – 16,0	84,0	43x47,3/40x43,5	10
		24055dLp 22/V2	22,0 – 19,0	84,0	43x47,3/40x43,5	10
		24055dLp 24/V2	24,0 – 21,0	84,0	43x47,3/40x43,5	10

i Passende Gegenmuttern ab Seite 442
Corresponding locknuts see from page 442

UNI Biegeschutz Dicht-Kabelverschraubung

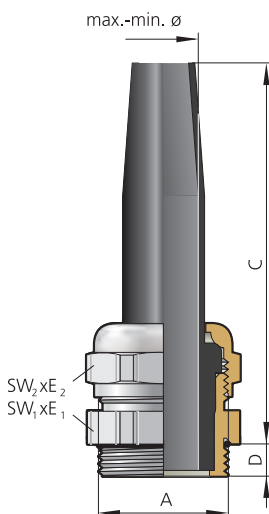
UNI Dicht Bending cable gland



Abb. 1
Fig. 1

Abb. 2
Fig. 2

Polycarbonat, Farbe: grau (RAL 7035), schwarz (RAL 9005)
Metrisches Anschlussgewinde EN 60423
Schutzart IP 68 bis 10 bar

Polycarbonate, colour: grey (RAL 7035), black (RAL 9005)
Metric connection thread EN 60423
Type of protection IP 68 up to 10 bar

i Schutzart IP 68/Type 4X ausschließlich in Verbindung mit separat erhältlicher Flachdichtung auf Seite 468
Type of protection IP 68/Type 4X only in combination with separately available flat seal ring on page 468

Werkstoff Verschraubungskörper Material gland body	Ausführung/Farbe Version/colour	Bestellschlüssel Art. no. supplement	Werkstoff Dichteinsatz Material sealing insert	Farbe Colour	Temperaturbereich min./max. Temperature range (min./max.)
PC	Grau Grey		TPE-V	Schwarz Black	-20 °C / +100 °C
PC	Schwarz Black	n	TPE-V	Schwarz Black	-20 °C / +100 °C



Abb. 3
Fig. 3

Anschlussgewinde/-länge Connection thread/length		Art.-Nr. Art. no.	Dichtbereich Sealing range	Bauhöhe Mounting height	Schlüsselweite Spanner width		
Ausführung bitte ergänzen Please complete product details							
A	D mm	Grau/Grey =	max./min. ø mm	C mm	SW ₁ x E ₁ /SW ₂ x E ₂ mm		
		Schwarz/Black = n					
M12x1,5	8,0	21249PC	Lp 4/V2	4,0– 2,5	55,0	15x16,5	50
		21249PC	Lp 5/V2	5,0– 3,5	55,0	15x16,5	50
		21249PC	Lp 6/V2	6,0– 4,5	55,0	15x16,5	50
		21249PC	Lp 6,5/V2	6,5– 5,5	55,0	15x16,5	50
M16x1,5	9,0	21650PC	Lp 5,5/V2	5,5– 4,0	68,0	19x21,2	50
		21650PC	Lp 6/V2	6,0– 5,0	68,0	19x21,2	50
		21650PC	Lp 7,5/V2	7,5– 5,5	68,0	19x21,2	50
M20x1,5	9,0	22051PC	Lp 5,5/V2	5,5– 4,0	75,0	24x26,5/22x24,4	50
		22051PC	Lp 6,5/V2	6,5– 5,0	75,0	24x26,5/22x24,4	50
		22052PC	Lp 6,5/V2	6,5– 5,0	80,0	24x26,5	50
		22052PC	Lp 7,5/V2	7,5– 6,0	80,0	24x26,5	50
		22051PC	Lp 8/V2	8,0– 6,0	75,0	24x26,5/22x24,4	50
		22052PC	Lp 8,5/V2	8,5– 7,0	80,0	24x26,5	50
		22051PC	Lp 9,5/V2	9,5– 7,5	75,0	24x26,5/22x24,4	50
		22052PC	Lp 10,5/V2	10,5– 8,0	80,0	24x26,5	50
M25x1,5	9,0	22553PC	Lp 8/V2	8,0– 6,0	85,0	30x33/27x29,5	25
		22553PC	Lp 9,5/V2	9,5– 7,5	85,0	30x33/27x29,5	25
		22553PC	Lp 11/V2	11,0– 9,0	85,0	30x33/27x29,5	25
		22553PC	Lp 13/V2	13,0– 10,5	85,0	30x33/27x29,5	25
M32x1,5	11,0	23254PC	Lp 10/V2	10,0– 8,0	82,0	36x39,5/33x36,5	10
		23254PC	Lp 11,5/V2	11,5– 9,5	82,0	36x39,5/33x36,5	10
		23254PC	Lp 13,5/V2	13,5– 11,0	82,0	36x39,5/33x36,5	10
		23254PC	Lp 15,5/V2	15,5– 13,0	82,0	36x39,5/33x36,5	10
		23254PC	Lp 17,5/V2	17,5– 15,0	82,0	36x39,5/33x36,5	10
M40x1,5	11,5	24055PC	Lp 19,5/V2	19,5– 16,0	84,0	46x50/43x46,5	10
		24055PC	Lp 22/V2	22,0– 19,0	84,0	46x50/43x46,5	10
		24055PC	Lp 24/V2	24,0– 21,0	84,0	46x50/43x46,5	10

i Passende Gegenmuttern ab Seite 442
Corresponding locknuts see from page 442

UNI Biegeschutz Dicht-Kabelverschraubung

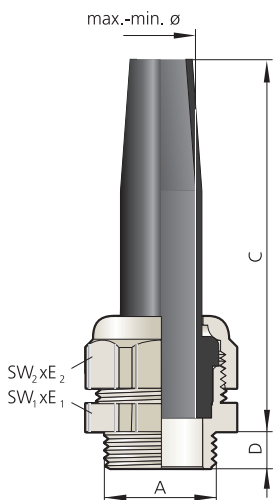
UNI Dicht Bending protection cable gland



Abb. 1
Fig. 1

Abb. 2
Fig. 2

PVDF, Farbe: transparent, blau, schwarz (RAL 9005)
Metrisches Anschlussgewinde EN 60423
Schutzart IP 68 bis 10 bar

PVDF, colour: transparent, blue, black (RAL 9005)
Metric connection thread EN 60423
Type of protection IP 68 up to 10 bar

i Anschlussgewinde mit 15 mm Länge auf Anfrage
Long connection thread 15 mm on request

Werkstoff Verschraubungskörper <i>Material gland body</i>	Ausführung/Farbe <i>Version/colour</i>	Bestellschlüssel <i>Art. no. supplement</i>	Werkstoff Dichteinsatz <i>Material sealing insert</i>	Farbe <i>Colour</i>	Temperaturbereich min./max. <i>Temperature range (min./max.)</i>
PVDF	Transparent		TPE-V	Schwarz Black	-40 °C / +135 °C
PVDF	Blau Blue	a	TPE-V	Schwarz Black	-40 °C / +135 °C
PVDF	Schwarz Black	n	TPE-V	Schwarz Black	-40 °C / +135 °C



Abb. 3
Fig. 3

Anschlussgewinde/-länge <i>Connection thread/length</i>		Art.-Nr. <i>Art. no.</i>	Dichtbereich <i>Sealing range</i>	Bauhöhe <i>Mounting height</i>	Schlüsselweite <i>Spanner width</i>		
		Ausführung bitte ergänzen <i>Please complete product details</i>					
		Transparent =					
		Blau/Blue = a					
		Schwarz/Black = n					
A	D mm		max./min. ø mm	C mm	SW₁ x E₁ / SW₂ x E₂ mm		
M12x1,5	8,0	21249y	Lp 4/V2	4,0– 2,5	55,0	15x16,5	50
		21249y	Lp 5/V2	5,0– 3,5	55,0	15x16,5	50
		21249y	Lp 6/V2	6,0– 4,5	55,0	15x16,5	50
		21249y	Lp 6,5/V2	6,5– 5,5	55,0	15x16,5	50
M16x1,5	9,0	21650y	Lp 5,5/V2	5,5– 4,0	65,0	19x21,2	50
		21650y	Lp 6/V2	6,0– 4,5	65,0	19x21,2	50
		21650y	Lp 7,5/V2	7,5– 5,5	65,0	19x21,2	50
M20x1,5	9,0	22051y	Lp 5,5/V2	5,5– 4,0	75,0	24x26,5/22x24,4	50
		22051y	Lp 6,5/V2	6,5– 5,0	75,0	24x26,5/22x24,4	50
		22052y	Lp 6,5/V2	6,5– 5,0	80,0	24x26,5	50
		22052y	Lp 7,5/V2	7,5– 5,5	80,0	24x26,5	50
		22051y	Lp 8/V2	8,0– 6,0	75,0	24x26,5/22x24,4	50
		22052y	Lp 8,5/V2	8,5– 7,0	80,0	24x26,5	50
		22051y	Lp 9,5/V2	9,5– 7,5	75,0	24x26,5/22x24,4	50
		22051y	Lp 9,5/V2	9,5– 7,5	75,0	24x26,5	50
		22052y	Lp10,5/V2	10,5– 8,0	72,0	24x26,5	50
		22052y	Lp10,5/V2	10,5– 8,0	80,0	24x26,5	50
M25x1,5	9,0	22553y	Lp 8/V2	8,0– 6,0	85,0	29x31,5/27x29,5	25
		22553y	Lp 9,5/V2	9,5– 7,5	85,0	29x31,5/27x29,5	25
		22553y	Lp11/V2	11,0– 9,0	85,0	29x31,5/27x29,5	25
		22553y	Lp13/V2	13,0– 10,5	85,0	29x31,5/27x29,5	25
M32x1,5	11,0	23254y	Lp10/V2	10,0– 8,0	82,0	38x42/33x36,5	10
		23254y	Lp11,5/V2	11,5– 9,5	82,0	38x42/33x36,5	10
		23254y	Lp13,5/V2	13,5– 11,0	82,0	38x42/33x36,5	10
		23254y	Lp15,5/V2	15,5– 13,0	82,0	38x42/33x36,5	10
		23254y	Lp17,5/V2	17,5– 15,0	82,0	38x42/33x36,5	10
M40x1,5	11,5	24055y	Lp19,5/V2	19,5– 16,0	88,0	46x50/43x46	10
		24055y	Lp22/V2	22,0– 19,0	88,0	46x50/43x46	10
		24055y	Lp24/V2	24,0– 21,0	88,0	46x50/43x46	10

i Schutzart IP 68 ausschließlich in Verbindung mit separat erhältlicher Flachdichtung auf Seite 468
Type of protection IP 68 only in combination with separately available flat sealing ring on page 468

UNI Flex Dicht-Kabelverschraubung

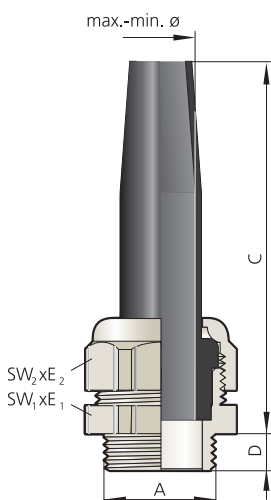
UNI Flex Dicht cable gland



Abb. 1
Fig. 1



Abb. 2
Fig. 2

Messing vernickelt, Feder aus Edelstahl
Metrisches Anschlussgewinde EN 60423
Mit O-Ring HNBR/Silikon
Schutzart IP 68 – statisch geprüft
Zugentlastung bis Klasse A, EN 62444

Brass, nickel-plated, spring made of stainless steel
Metric connection thread EN 60423
With o-ring HNBR/silicone
Type of protection IP 68 – statically tested
Strain relief up to class A, EN 62444

i Flexible Leitungen an Robotern, Handbediengeräten, Fußschaltern etc. sind am Gerät besonderen Beanspruchungen unterworfen. Die UNI Flex gibt den Leitungen einen definierten Biegeradius und schützt vor Aderbruch.
Flexible lines on robots, hand controllers, foot switches, etc. are subjected to special loads at the cross-over to the equipment. The UNI Flex provides the lines with a defined bending radius and protection against conductor breaks.

Werkstoff Verschraubungskörper Material gland body	Ausführung/Farbe Version/colour	Werkstoff Dichteinsatz Material sealing insert	Farbe Colour	Bestellschlüssel Art. no. supplement	Temperaturbereich min./max. Temperature range (min./max.)
Messing Brass	Vernickelt Nickel-plated	TPE	s. FC s. CC		-40 °C / +130 °C
Messing Brass	Vernickelt Nickel-plated	TPE-V	Natur Natural	p	-40 °C / +135 °C
Messing Brass	Vernickelt Nickel-plated	Silikon HT Silicone HT	Schwarz Black	H	-55 °C / +200 °C



Abb. 3
Fig. 3

Anschlussgewinde/-länge Connection thread/length		Art.-Nr. Art. no.	Dichtbereich Sealing range	Bauhöhe Mounting height	Schlüsselweite Spanner width	
		Ausführung bitte ergänzen Please complete product details				
A	D mm	TPE = TPE-V = p Silikon HT/Silicone HT = H	max./min. ø mm	C mm	SW₁ x E₁ / SW₂ x E₂ mm	
M16x1,5	6,0	21652dF	14.07V2 6,5 – 4,0	80,0	22x24,4	25
		21652dF	14.09V2 9,5 – 6,5	80,0	22x24,4	25
		21652dF	14.11V2 10,5 – 7,0	80,0	22x24,4	25
M20x1,5	6,5	22052dF	14.07V2 6,5 – 4,0	82,0	22x24,4	25
		22052dF	14.08V2 8,0 – 5,0	82,0	22x24,4	25
		22052dF	14.09V2 9,5 – 6,5	82,0	22x24,4	25
		22052dF	14.11V2 10,5 – 7,0	82,0	22x24,4	25
		22052dF	14.13V2 13,0 – 9,0	82,0	22x24,4	25
		22053dF	16.16V2 15,5 – 11,5	82,0	24x26,7	25
M25x1,5	7,5	22553dF	16.11V2 10,5 – 7,0	85,0	28x31,2/24x26,7	25
		22553dF	16.13V2 13,0 – 9,0	85,0	28x31,2/24x26,7	25
		22553dF	16.16V2 15,5 – 11,5	85,0	28x31,2/24x26,7	25
		22554dF	19.18V2 18,0 – 14,0	90,0	30x33,5	25
M32x1,5	8,0	23254dF	19.18V2 18,0 – 14,0	90,0	35x38,5/30x33,5	10

i Passende Gegenmuttern ab Seite 442
Corresponding locknuts see from page 442

UNI Biege Zug-Kabelverschraubung

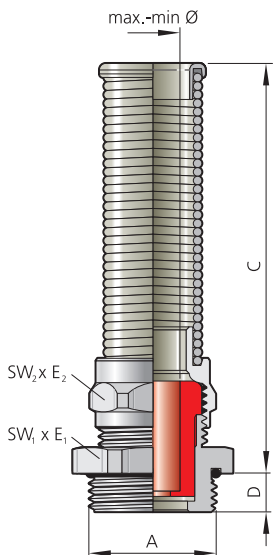
UNI Bending Strain relief cable gland



Abb. 1
Fig. 1



Abb. 2
Fig. 2

Messing vernickelt
Metrisches Anschlussgewinde EN 60423
Mit O-Ring HNBR
Schutzart IP 54
Integrierte Zugentlastung – vibrationsfest

Brass, nickel-plated
Metric connection thread EN 60423
With o-ring HNBR
Type of protection IP 54
Integrated strain relief – vibration resistant

i Anschlussgewinde mit 15 mm Länge auf Anfrage
Long connection thread 15 mm on request

Werkstoff Verschraubungskörper <i>Material gland body</i>	Ausführung/Farbe <i>Version/colour</i>	Werkstoff Dichteinsatz <i>Material sealing insert</i>	Farbe <i>Colour</i>	Temperaturbereich min./max. <i>Temperature range (min./max.)</i>
Messing Brass	Vernickelt Nickel-plated	TPE-V	Schwarz Black	-20 °C / +100 °C



Abb. 3
Fig. 3

Anschlussgewinde/-länge <i>Connection thread/length</i>	Art.-Nr. <i>Art. no.</i>	Dichtbereich <i>Sealing range</i>	Bauhöhe <i>Mounting height</i>	Schlüsselweite <i>Spanner width</i>		
A	D	max./min. ø	C	SW ₁ x E ₁ /SW ₂ x E ₂	mm	
M12x1,5	5,0	21250dLzp 7*	6,5 – 4,5	54,0	17x18,9	50
M16x1,5	6,0	21650dLzp 7	6,5 – 4,5	54,0	18x20/17x18,9	50
		21651dLzp 9*	9,0 – 6,0	63,0	20x22,2	50
		21652dLzp 9*	9,5 – 6,5	68,0	22x24,4	50
		21652dLzp11*	10,5 – 8,5	68,0	22x24,4	50
M20x1,5	6,5	22051dLzp 9	9,5 – 6,5	69,0	22x24,4/20x22,2	50
		22052dLzp 9	9,5 – 6,5	69,0	22x24,4	50
		22052dLzp11	10,5 – 8,5	69,0	22x24,4	50
		22053dLzp13*	13,0 – 9,0	77,0	24x26,7	25
		22054dLzp16*	15,5 – 13,0	78,0	30x33,5	10
M25x1,5	7,5	22553dLzp 9	9,5 – 6,5	73,0	28x31,2/24x26,7	25
		22553dLzp11	10,5 – 8,5	73,0	28x31,2/24x26,7	25
		22553dLzp13	13,0 – 9,0	73,0	28x31,2/24x26,7	25
		22554dLzp16*	15,5 – 13,0	78,0	30x33,5	10
M32x1,5	8,0	23254dLzp13	13,0 – 9,0	78,0	35x38,5/30x33,5	10
		23254dLzp16	15,5 – 13,0	78,0	35x38,5/30x33,5	10
		23254dLzp18	17,5 – 14,0	78,0	35x38,5/30x33,5	10
		23255dLzp21*	20,0 – 17,0	103,0	40x43,5	10
M40x1,5	8,0	24055dLzp21	20,0 – 17,0	104,0	43x47,3/40x43,5	10
		24055dLzp25	24,5 – 21,0	104,0	43x47,3/40x43,5	5

* Dichteinsatz kurz = Art.-Nr.: Ek...
* Sealing insert short = art. no.: Ek...

i Passende Gegenmuttern ab Seite 442
Corresponding locknuts see from page 442

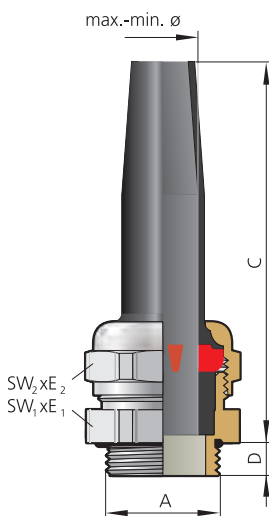
UNI Biege Zug-Kabelverschraubung

UNI Bending Strain relief cable gland



Abb. 1
Fig. 1



Abb. 2
Fig. 2

Polycarbonat, Farbe: grau (RAL 7035), schwarz (RAL 9005)
Metrisches Anschlussgewinde EN 60423
Schutzart IP 54
Integrierte Zugentlastung – vibrationsfest

Polycarbonate, colour: grey (RAL 7035), black (RAL 9005)
 Metric connection thread EN 60423
 Type of protection IP 54
 Integrated strain relief – vibration resistant

Werkstoff Verschraubungskörper Material gland body	Ausführung/Farbe Version/colour	Bestellschlüssel Art. no. supplement	Werkstoff Dichteinsatz Material sealing insert	Farbe Colour	Temperaturbereich min./max. Temperature range (min./max.)
PC	Grau Grey		TPE-V	Schwarz Black	-20 °C / +100 °C
PC	Schwarz Black	n	TPE-V	Schwarz Black	-20 °C / +100 °C



Abb. 3
Fig. 3

Anschlussgewinde/-länge Connection thread/length		Art.-Nr. Art. no.	Dichtbereich Sealing range	Bauhöhe Mounting height	Schlüsselweite Spanner width		
		Ausführung bitte ergänzen Please complete product details					
A	D mm	Grau/Grey = Schwarz/Black = n	max./min. ø mm	C mm	SW₁ x E₁/SW₂ x E₂ mm		
M12x1,5	8,0	21250PC	Lzp 7 *	6,5 – 4,5	55,0	19x21,2	50
M16x1,5	9,0	21650PC	Lzp 7	6,5 – 4,5	58,0	19x21,2	50
M16x1,5	8,5	21651PC	Lzp 9 *	9,0 – 6,5	64,0	22x24,5	50
M20x1,5	9,0	22052PC	Lzp 9 *	9,5 – 6,5	72,0	24x26,5	50
		22052PC	Lzp 11 *	10,5 – 8,5	72,0	24x26,5	50
		22053PC	Lzp 13 *	13,0 – 9,0	75,0	27x29,5	25
M25x1,5	9,0	22553PC	Lzp 9	9,5 – 6,5	80,0	30x33/27x29,5	25
		22553PC	Lzp 11	10,5 – 7,0	80,0	30x33/27x29,5	25
		22553PC	Lzp 13	13,0 – 9,0	80,0	30x33/27x29,5	25
M25x1,5	11,0	22554PC	Lzp 16 *	15,5 – 13,0	80,0	33x36,5	10
		22554PC	Lzp 18 *	17,5 – 14,0	80,0	33x36,5	10
M32x1,5	11,0	23254PC	Lzp 13	13,0 – 9,0	80,0	36x39,5/33x36,5	10
		23254PC	Lzp 16	15,5 – 13,0	80,0	36x39,5/33x36,5	10
		23254PC	Lzp 18	17,5 – 14,0	80,0	36x39,5/33x36,5	10
		23255PC	Lzp 21 *	20,5 – 17,0	104,0	43x46	10
M40x1,5	11,5	23255PC	Lzp 25 *	24,0 – 20,0	104,0	43x46	10
		24055PC	Lzp 21	20,5 – 17,0	108,0	46x50/43x46,5	5
		24055PC	Lzp 25	24,0 – 20,0	108,0	46x50/43x46,5	5

* Dichteinsatz kurz = Art.-Nr.: Ek...
 * Sealing insert short = art. no.: Ek...

i **Passende Gegenmütern ab Seite 442**
 Corresponding locknuts see from page 442

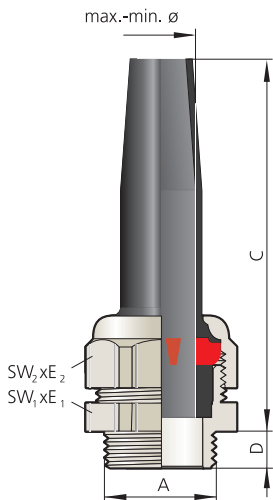
UNI Biege Zug-Kabelverschraubung

UNI Bending Strain relief cable gland



Abb. 1
Fig. 1



Abb. 2
Fig. 2

PVDF, Farbe: transparent, blau (RAL 5015), schwarz (RAL 9005)
Metrisches Anschlussgewinde EN 60423
Schutzart IP 54
Integrierte Zugentlastung – vibrationsfest

PVDF, colour: transparent, blue (RAL 5015), black (RAL 9005)
Metric connection thread EN 60423
Type of protection IP 54
Integrated strain relief – vibration resistant

Werkstoff Verschraubungskörper Material gland body	Ausführung/Farbe Version/colour	Bestellschlüssel Art. no. supplement	Werkstoff Dichteinsatz Material sealing insert	Farbe Colour	Temperaturbereich min./max. Temperature range (min./max.)
PVDF	Transparent		TPE-V	Schwarz Black	-20 °C / +100 °C
PVDF	Blau Blue	a	TPE-V	Schwarz Black	-20 °C / +100 °C
PVDF	Schwarz Black	n	TPE-V	Schwarz Black	-20 °C / +100 °C



Abb. 3
Fig. 3

Anschlussgewinde/-länge Connection thread/length		Art.-Nr. Art. no.	Dichtbereich Sealing range	Bauhöhe Mounting height	Schlüsselweite Spanner width	
		Ausführung bitte ergänzen Please complete product details				
		Transparent =				
A	D	Blau/Blue = a	max./min. ø	C	SW₁ x E₁	SW₂ x E₂
	mm	Schwarz/Black = n	mm	mm	mm	mm
M16x1,5	9,0	21650y	Lzp 7	6,5– 4,5	55,0	19x21,2
M16x1,5	8,5	21651y	Lzp 9	9,0– 6,5	64,0	22x24,5
M20x1,5	9,0	22052y	Lzp 9	9,5– 6,5	72,0	24x26,5
		22052y	Lzp11	10,5– 8,5	72,0	24x26,5
		22053y	Lzp13	13,0– 9,0	76,0	27x29,5
M25x1,5	9,0	22553y	Lzp 9	9,5– 6,5	80,0	29x31,5/27x29,5
		22553y	Lzp11	10,5– 7,0	80,0	29x31,5/27x29,5
		22553y	Lzp13	13,0– 9,0	80,0	29x31,5/27x29,5
M25x1,5	11,0	22554y	Lzp16	15,5– 13,0	80,0	33x36,5
		22554y	Lzp18	17,5– 14,0	80,0	33x36,5
		22555y	Lzp21	20,0– 17,0	104,0	43x46
M32x1,5	11,0	23254y	Lzp13	13,0– 9,0	80,0	38x42/33x36,5
		23254y	Lzp16	15,5– 13,0	80,0	38x42/33x36,5
		23254y	Lzp18	17,5– 14,0	80,0	38x42/33x36,5
		23255y	Lzp21	20,0– 17,0	104,0	43x46
		23255y	Lzp25	24,0– 21,0	104,0	43x46
M40x1,5	11,5	24055y	Lzp21	20,0– 17,0	108,0	46x50/43x46,5
		24055y	Lzp25	24,0– 21,0	108,0	46x50/43x46,5

13500 | IT000700

Übersichtstabelle für die UNI Dicht-Komponenten – M

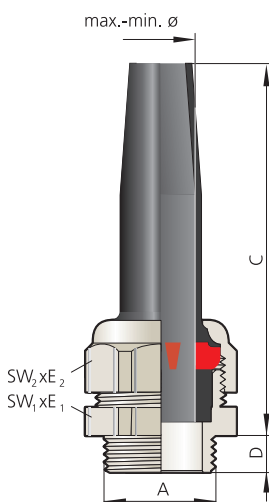
Overview of UNI Dicht components – M

Messing vernickelt, VA: 1.4305, Polycarbonat: Farbe grau (RAL 7035), PVDF: Farbe transparent, mit metr. Gewinde EN 60423, Schutzart IP 68 bis 10 bar

Brass, nickel-plated, stainless steel: AISI 303, polycarbonate: colour grey (RAL7035), PVDF: colour transparent, with metric connecting thread EN 60423, type of protection IP 68 up to 10 bar

Anschlussgewinde Connection thread	Messing vernickelt Brass, nickel-plated			Edelstahl 1.4305 Stainless steel AISI 303			Polycarbonat Polycarbonate
	DS ¹⁾	DN ¹⁾	VK ¹⁾	DS ¹⁾	DN ¹⁾	VK ¹⁾	DS ¹⁾
M4x0,7	DS 205d	DN 20405d	VK 20405d				
M6x0,75	DS 206d	DN 206d	VK 206d				
M8x1,0	DS 210208d	DN 208210d	VK 208210d				
M10x1,0	DS 149d	DN 21049d/1mm	VK 21049d/1mm	DS 149st	DN 21049d/1mm	VK 21049st/1mm	
M10x1,5	DS 149d	DN 21049d/1,5mm	VK 21049d/1,5mm				
M12x1,5	DS 149d	DN 21249d *	VK 21249d *	DS 149st	DN 21249st *	VK 21249st *	DS 149PC
M12x1,5	DS 150d	DN 21250d	VK 21250d				
M16x1,5	DS 150d	DN 21650d	VK 21650d	DS 150st	DN 21650st	VK 21650st	DS 150PC
M16x1,5	DS 151d	DN 21651d	VK 21651d	DS 151st	DN 21651st	VK 21651st	DS 151PC
M20x1,5	DS 152d	DN 22052d	VK 22052d	DS 152st	DN 22052st	VK 22052st	DS 152PC
M20x1,5	DS 153d	DN 22053d	VK 22053d	DS 153st	DN 22053st	VK 22053st	DS 153PC
M25x1,5	DS 153d	DN 22553d	VK 22553d	DS 153st	DN 22553st	VK 22553st	DS 153PC
M25x1,5	DS 154d18	DN 22554d	VK 22554d	DS 154st18	DN 22554st	VK 22554st	DS 154PC
M25x1,5	DS 154d21	DN 22554d	VK 22554d21	DS 154st21	DN 22554st	VK 22554st21	
M32x1,5	DS 154d18	DN 23254d	VK 23254d	DS 154st18	DN 23254st	VK 23254st	DS 154PC
M32x1,5	DS 154d21	DN 23254d	VK 23254d20	DS 154st21	DN 23254st	VK 23254st20	DS 154PC
M32x1,5	DS 155d	DN 23255d	VK 23255d	DS 155st	DN 23255st	VK 23255st	DS 155PC
M40x1,5	DS 155d	DN 24055d	VK 24055d	DS 155st	DN 24055st	VK 24055st	DS 155PC
M40x1,5	DS 156d	DN 24056d	VK 24056d	DS 156st	DN 24056st	VK 24056st	DS 156PC
M50x1,5	DS 156d	DN 25056d	VK 25056d	DS 156st	DN 25056st	VK 25056st	DS 156PC
M50x1,5	DS 157d	DN 25057d	VK 25057d	DS 157st	DN 25057st	VK 25057st	
M63x1,5	DS 158d	DN 26358d	VK 26358d	DS 158st	DN 26358st	VK 26358st	

1) Abkürzungen siehe Seite 74 bis 79 * Dichteinsatz kurz = Art.-Nr.: Ek... ** Werkstoff POM (Farbe weiß), Temperaturbereich: -40 °C bis +110 °C.

1) Abbreviations see page 74 to 79 * Sealing insert short = art. no.: Ek... ** Material POM (white colour), temperature range: -40 °C up to +110 °C

0 bar

Polycarbonat Polycarbonate		PVDF PVDF			Dichteinsätze Sealing inserts			
DN ¹⁾	VK ¹⁾	DS ¹⁾	DN ¹⁾	VK ¹⁾	TPE	TPE-V	Silikon silicone	TPE geschlossen TPE closed
					Ek204/1,6			
						Ek206kp 3		
					Ek149/ 7	Ek149p 7	E 149i 7 HF/HT	Ek149g
					Ek149/ 7	Ek149p 7	E 149i 7 HF/HT	Ek149g
DN 21249PC	VK 21249PC *	DS 149y	DN 21249y *	VK 21249y *	Ek149/ 7	Ek149p 7	E 149i 7 HF/HT	Ek149g
					Ek150/ 8	Ek150p 8	E 150i 8 HF/HT	Ek150g
					Ek150/ 9	Ek150p 9	E 150i 9 HF/HT	
DN 21650PC	VK 21650PC	DS 150y	DN 21650y	VK 21650y	E 150/ 7	E 150p 7	E 150i 7/HT	E 150g
					E 150/ 8	E 150p 8	E 150i 8/HT	
					E 150/ 9	E 150p 9	E 150i 9/HT	
DN 21651PC	VK 21651PC	DS 151y	DN 21651y	VK 21651y	Ek151/ 9	Ek151p 9	E 151i 9 HF/HT	Ek151g
					Ek151/11	Ek151p11	E 151i11 HF/HT	
DN 22052PC	VK 22052PC *	DS 152y	DN 22052y *	VK 22052y *	E 152/ 7	E 152p 7	E 152i 7/HT	E 152g
					E 152/ 8	E 152p 8	E 152i 8/HT	
					E 152/ 9	E 152p 9	E 152i 9/HT	
					E 152/11	E 152p11	E 152i11/HT	
					E 152/13	E 152p13	E 152i13/HT	
DN 22053PC	VK 22053PC	DS 153y	DN 22053y	VK 22053y	Ek153/11	Ek153p11	E 153i11 HF/HT	Ek153g
					Ek153/13	Ek153p13	E 153i13 HF/HT	
					Ek153/16	Ek153p16	E 153i16 HF/HT	
DN 22553PC	VK 22553PC	DS 153y	DN 22553y	VK 22553y	E 153/ 7	E 153p 7	E 153i 7/HT	E 153g
					E 153/ 8	E 153p 8	E 153i 8/HT	
					E 153/ 9	E 153p 9	E 153i 9/HT	
					E 153/11	E 153p11	E 153i11/HT	
					E 153/13	E 153p13	E 153i13/HT	
					E 153/16	E 153p16	E 153i16/HT	
DN 22554PC	VK 22554PC	DS 154y	DN 22554y	VK 22554y	Ek154/13	Ek154p13	E 154i13 HF/HT	Ek154g
					Ek154/16	Ek154p16	E 154i16 HF/HT	
					Ek154/18	Ek154p18	E 154i18 HF/HT	
		DS 154y	DN 22554y	VK 22554y	Ek154/20	Ek154p20	E 154i20 HF/HT	Ek154g
DN 23254PC	VK 23254PC	DS 154y	DN 23254y	VK 23254y	E 154/11	E 154p11	E 154i11/HT	E 154g
					E 154/13	E 154p13	E 154i13/HT	
					E 154/16	E 154p16	E 154i16/HT	
					E 154/18	E 154p18	E 154i18/HT	
DN 23254PC	VK 23254PC	DS 154y	DN 23254y	VK 23254y	E 154/20	E 154p20	E 154i20/HT	E 154g
DN 23255PC	VK 23255PC	DS 155y	DN 23255y	VK 23255y	Ek155/18	Ek155p18	E 155i18 HF/HT	Ek155g
					Ek155/20	Ek155p20	E 155i20 HF/HT	
					Ek155/25	Ek155p25	E 155i25 HF/HT	
					Ek155/28	Ek155p28	E 155i28 HF/HT	
DN 24055PC	VK 24055PC	DS 155y	DN 24055y	VK 24055y	E 155/16	E 155p16	E 155i16/HT	E 155g
					E 155/18	E 155p18	E 155i18/HT	
					E 155/20	E 155p20	E 155i20/HT	
					E 155/25	E 155p25	E 155i25/HT	
					E 155/28	E 155p28	E 155i28/HT	
DN 24056PC	VK 24056PC	DS 156y	DN 24056y	VK 24056y	Ek156/32	Ek156p32	E 156i32 HF/HT	Ek156g
					Ek156/34	Ek156p34	E 156i34 HF/HT	
					Ek156/36	Ek156p36	E 156i36 HF/HT	
DN 25056PC	VK 25056PC	DS 156y	DN 25056y	VK 25056y	E 156/32	E 156p32	E 156i32/HT	E 156g
					E 156/34	E 156p34	E 156i34/HT	
					E 156/36	E 156p36	E 156i36/HT	
		DS 157p **	DN 25057p **	VK 25057y **	E 157/40 HF	E 157p40 HF		Ek157g
		DS 158p **	DN 26358p **	VK 26358y **	E 158/44	E 158p44		E 158g

Die bewährte UNI Dicht – Pg
Tried and tested: UNI Dicht – Pg



Abb. 1 – UNI Zug Dicht-Kabelverschraubung
Fig. 1 – UNI Dicht Strain relief cable gland

Abb. 2 – UNI Mehrfach mit geteiltem Dichteinsatz für konfektionierte Kabel
Fig. 2 – UNI Multiple with split sealing insert for pre-assembled cables

Anwendungsorientierte Individualität

Das PFLITSCH-Kabelverschraubungssystem UNI Dicht erfüllt mit seiner Typenvielfalt viele weltweite Anforderungen für Kabel- und Leitungseinführungen. EMV- und Ex-Schutz, Lösungen für das Einführen von Flach- und Sonderkabeln (z. B. ASI-Bus) oder konfektionierten Kabeln durch geteilte Dichteinsätze oder mehrere Leitungen durch eine Mehrfach-Kabelverschraubung sind ebenso vorhanden wie Winkel- und Flanschverschraubungen. Auch Kombinationen mit Wellrohren und Schutzschläuchen für einen umfassenden mechanischen Kabelschutz sind möglich.

Individualität in Metall und Kunststoff

Die UNI Dicht-Kabelverschraubung besteht aus einem Verschraubungskörper und einem entsprechenden Dichteinsatz. Aus diesen Systemteilen stellt sich der Anwender seine individuelle Verschraubung zusammen – passend zu Einsatzbedingungen, Kabeldurchmessern, Umgebungstemperaturen, Anzahl der Kabel usw. Das ist Individualität in Serienqualität!

UNI Dicht gibt es in den aktuellen Größen Pg 7 bis Pg 48, weiterhin aber auch mit den gängigen M-Gewinden und mit internationalen Sondergewinden wie NPT oder Zoll. Die Verschraubungskörper sind verfügbar in den Metallen Messing, Zink, Edelstahl, Aluminium und in den Kunststoffen PVDF und Polycarbonat. Die Dichteinsätze fertigt PFLITSCH aus den hochwertigen Materialien TPE, TPE-V und Silikon. Diese thermoplastischen Elastomere (TPE + TPE-V) und das Silikon sind resistent gegen Chemikalien und sorgen für eine verbesserte Zugentlastung, da sie z. B. in Kontakt mit Schneidölen, ihr Volumen leicht vergrößern. Darüber hinaus erfüllen die Verschraubungen serienmäßig hohe Schutzarten bis zu IP 68 (bis 10 bar) bzw. IP 69.

Baukastensystem für alle Anforderungen

Entsprechend den Einsatzanforderungen kann der Anwender seine individuelle Kabelverschraubung zusammenstellen: Ein bestimmtes Anschlussgewinde, Biegeschutz, erhöhte Zugentlastung, Winkelverschraubungen, Abdichtung von Flachkabeln, geteilte Dichteinsätze für konfektionierte Kabel oder die Kombination mit Schläuchen oder Wellrohren sind im System einfach zu realisieren. Sind vorhandene Bohrungen zu klein, hilft UNI Dicht in der erweiterten Bauform. Auch das „Lochen nach Wunsch“ ist auf Anfrage möglich.

Application-oriented individuality

With its multiplicity of types, the PFLITSCH cable gland system UNI Dicht fulfils all the EU requirements for line and cable entries. Solutions for EMC and explosion protection, insertion of flat and special cables (e.g. ASI-Bus) or pre-assembled cables through divided sealing inserts or several – even different – lines by a multiple gland can be realised, as well as angle and flange glands. Combinations with corrugated pipes and protective hoses for comprehensive mechanical cable protection are possible.

Individuality in metal and plastic

The UNI Dicht gland comprises a gland body and an individual sealing insert. Users assemble their individual gland from these system parts in order to meet their conditions of application, the cable diameters, ambient temperatures, number of cables, etc. This is individuality in serial quality!

UNI Dicht currently comes in the sizes Pg 7 to Pg 48, as well as in the well-established M threads and with international special threads such as NPT or inch. The system is available in the metals brass, zinc, stainless steel and aluminium, and in the plastics PVDF and polycarbonate. PFLITSCH produces the sealing inserts from high-grade TPE, TPE-V and silicone. These thermoplastic elastomers (TPE + TPE-V) and the silicone are resistant to many modern chemicals and make for improved strain relief, since volume increases slightly on contact with liquids, for example cutting oil. Furthermore, the cable glands achieve a high protection rating of up to IP 68 (up to 10 bar) or IP 69 as standard.

Modular system for all requirements

Users can fit their individual cable gland to meet the application requirements: Another connecting thread, bending protection, increased strain relief, angle glands, sealing of flat cables, split sealing inserts for pre-assembled cables or the combination with hoses or corrugated pipes are simple to achieve in the system. Should existing boreholes be a little too small, UNI Dicht will help in the extended configuration. Customised perforations are also available on request.



1



2



Pg

Abb. 1 – Kabelverschraubung mit geschlossenem Dichteinsatz
Fig. 1 – Cable gland with closed sealing insert

Abb. 2 – UNI Biegeschutz Dicht-Kabelverschraubung
Fig. 2 – UNI Dicht Bending protection cable gland

**Das PFLITSCH-System
UNI Dicht Pg
Systemteile/Seitenübersicht**

*The PFLITSCH system
UNI Dicht Pg
System parts/Page reference*

DS = Druckschraube
DS = pressure screw

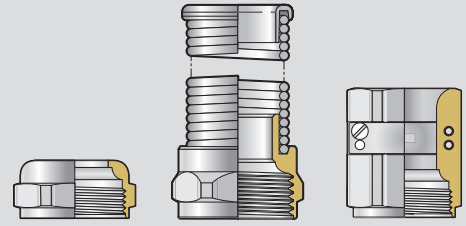

Werkstoff <i>Material</i>	Standard <i>Standard</i>	UNI Flex <i>UNI Flex</i>	UNI Klemm <i>UNI Clamping</i>
Messing <i>Brass</i>	Seite 144 <i>Page 144</i>	Seite 184 <i>Page 184</i>	Seite 179-180 <i>Page 179-180</i>
Edelstahl <i>Stainless steel</i>	Seite 145-146 <i>Page 145-146</i>		
Polycarbonat <i>Polycarbonate</i>	Seite 147 <i>Page 147</i>		
PVDF <i>PVDF</i>	Seite 148-149 <i>Page 148-149</i>		

E = Dichteinsatz
E = sealing insert



Werkstoff <i>Material</i>	Standard <i>Standard</i>	Erweitert kurz <i>Extended short</i>	Erhöhte Zugentlastung <i>Increased strain relief</i>	EMV HF <i>EMC HF</i>	EMV Konus <i>EMC cone</i>	Mehrfach Form N <i>Multiple form N</i>
TPE <i>TPE</i>	Seite 144-149 <i>Page 144-149</i>	Seite 152-154 <i>Page 152-154</i>	Seite 176-178 <i>Page 176-178</i>	Seite 233-235 <i>Page 233-235</i>	Seite 252-253 <i>Page 252-253</i>	Seite 158-163 <i>Page 158-163</i>
TPE-V <i>TPE-V</i>	Seite 144-149 <i>Page 144-149</i>	Seite 152-154 <i>Page 152-154</i>	Seite 176-178 <i>Page 176-178</i>	Seite 233-235 <i>Page 233-235</i>	Seite 252-253 <i>Page 252-253</i>	Seite 158-163 <i>Page 158-163</i>
Silikon <i>Silicone</i>	Seite 144-149 <i>Page 144-149</i>	Seite 152-154 <i>Page 152-154</i>		Seite 233-235 <i>Page 233-235</i>	Seite 252 <i>Page 252</i>	

DN = Doppelnippel
DN = double nipple



Werkstoff <i>Material</i>	Gewindelänge Standard <i>Standard thread length</i>
Messing <i>Brass</i>	Seite 144 <i>Page 144</i>
Edelstahl <i>Stainless steel</i>	Seite 145-146 <i>Page 145-146</i>
Polycarbonat <i>Polycarbonate</i>	Seite 147 <i>Page 147</i>
PVDF <i>PVDF</i>	Seite 148-149 <i>Page 148-149</i>
Zink <i>Zinc</i>	

DS & DN = VK (Verschraubungskörper)
DS & DN = VK (gland body)

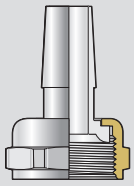

Glatte Schläuche dünnwandig
Plain, thin-walled hoses

Auf Anfrage
On request

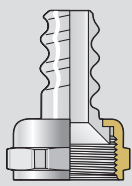

UL-Schlauch
UL hose

Seite 422
Page 422

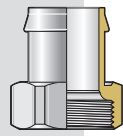

Glatte Schläuche
Plain hose

Seite 424-425
Page 424-425

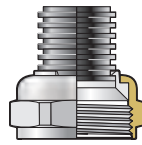

UNI Wellrohr
UNI corrugated conduit

Seite 407
Page 407

Auf Anfrage
On request

Auf Anfrage
On request

Seite 426
Page 426

Auf Anfrage
On request

Seite 423
Page 423

Auf Anfrage
On request



Mehrfach Form E
Multiple form E

Seite 158-163
Page 158-163

Seite 158-163
Page 158-163

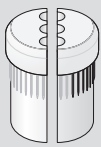

Mehrfach geteilt
Multiple split version

Seite 165-166
Page 165-166



Geschlossen
Closed

Seite 164
Page 164

Seite 164
Page 164

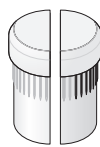

Geschlossen – geteilt
Closed – split version

Seite 165-166
Page 165-166



Flachkabel
Flat cable

Seite 169-173
Page 169-173

Seite 169-173
Page 169-173



ASi-Bus-Kabel
ASi-Bus cable

Seite 167-168
Page 167-168



Biegeschutz
Bending protection

Seite 181-183
Page 181-183

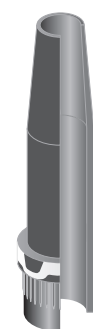

Biegeschutz/erhöhte Zugentlastung
Bending protection incl. strain relief

Seite 185-187
Page 185-187

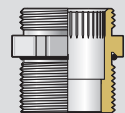

Gewindelänge lang
Long thread length

Seite 144
Page 144

Seite 145-146
Page 145-146

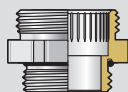

Form E erweitert
Form E extended

Seite 152
Page 152

Seite 153
Page 153

Auf Anfrage
On request

Seite 154
Page 154

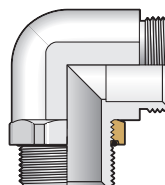

Winkel
Angle

Seite 369
Page 369

**Das PFLITSCH-System
UNI Dicht Pg
Aufbau der Artikelnummern**

*The PFLITSCH system
UNI Dicht Pg
Article number structure*

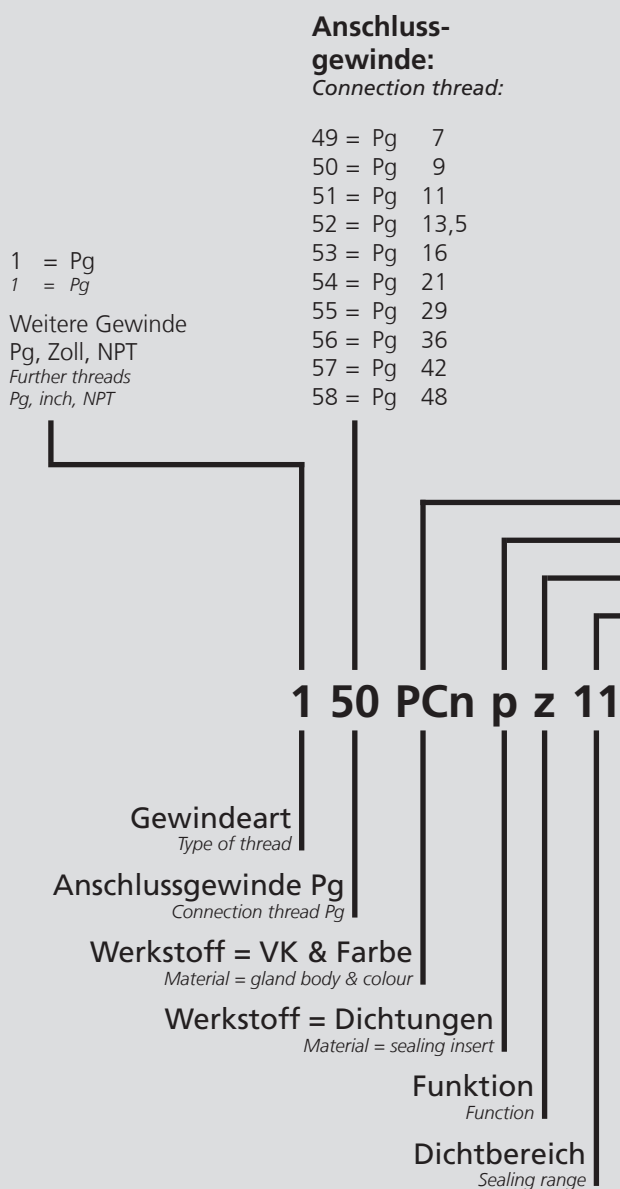

Werkstoffe

Verschraubungskörper:

Materials gland body:

d	= Messing vernickelt <i>brass, nickel plated</i>	
st	= VA (1.4305) <i>AISI 303</i>	
PC	= Polycarbonat <i>polycarbonate</i>	
PCn	= Polycarbonat <i>polycarbonate</i>	Farbe schwarz <i>Colour black</i>
PCw	= Polycarbonat <i>polycarbonate</i>	Winkel <i>Angle</i>
y	= PVDF	Farbe transparent <i>Colour transparent</i>
ya	= PVDF	Farbe blau <i>Colour blue</i>
yn	= PVDF	Farbe schwarz <i>Colour black</i>
VW	= Zink <i>zinc</i>	Winkel <i>Angle</i>

Werkstoffe

Dichtungen:

Materials sealing inserts:

-	= TPE
p	= TPE-V
H	= Silikon <i>silicone</i>

Funktion:

Function:

-	= Standard-Dichteinsatz <i>standard sealing insert</i>
z	= Zugentlastung <i>strain relief</i>
e	= Entstörung <i>interference suppression</i>
ez	= Entstörung & Zugentlastung <i>interference suppression & strain relief</i>
L	= Biegeschutz <i>bending protection</i>
Lz	= Biegeschutz & Zugentlastung <i>bending protection & strain relief</i>
m	= Mehrfach <i>multiple</i>
mK	= Multifunktion (Stecker) <i>multifunction (connector)</i>
s	= Schlauch <i>hose</i>
f...g	= flach gerundet <i>flat rounded</i>
f...v	= flach oval <i>flat oval</i>
f...e	= flach eckig <i>flat angular</i>
F	= Flex <i>flex</i>
W	= Wellrohr <i>corrugated</i>
UL	= Schlauchverschraubung <i>UL hose</i>
g	= geschlossen <i>closed</i>
B	= Brandschutz <i>fire protection</i>

Dichtbereich:

Sealing range:

7	= 6,5 - 4,0
8	= 8,0 - 5,0
9	= 9,5 - 6,5
11	= 10,5 - 7,0
13	= 13,0 - 9,0
16	= 15,5 - 11,5
18	= 18,0 - 14,0
20	= 20,5 - 17,0
25	= 25,0 - 20,0
28	= 28,0 - 24,0
32	= 32,0 - 27,0
34	= 34,0 - 29,0
36	= 36,0 - 32,0
40	= 40,0 - 36,0
44	= 44,0 - 39,0

Das PFLITSCH-System UNI Dicht – Komponenten

The PFLITSCH system
UNI Dicht –
components

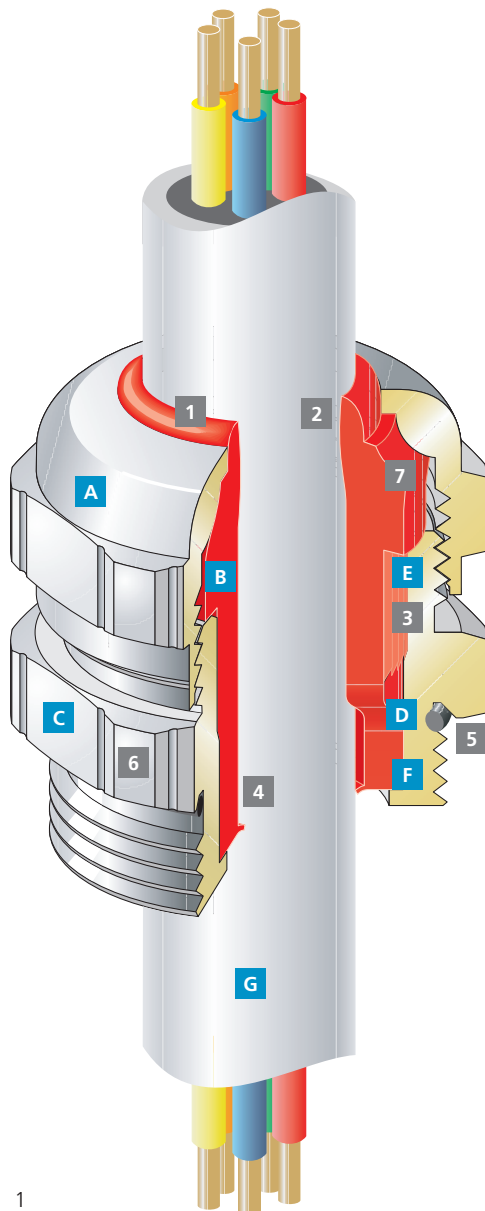

1

Abb. 1 – Querschnitt einer UNI Dicht-Kabelverschraubung
Fig. 1 – Cross-section of a UNI Dicht cable gland

Komponenten:

Components:

- A** Druckschraube (DS)
Pressure screw (DS)
 - Messing, galvanisch vernickelt
- Brass, galvanic nickel-plated
 - Edelstahl (1.4305)
- Stainless steel (AISI 303)
 - Edelstahl (1.4571)
- Stainless steel (AISI 316 Ti)
 - Polycarbonat (PC)
- Polycarbonate (PC)
 - PVDF
 - PVDF

- B** Dichteinsatz (E)
Sealing insert (E)
 - TPE
 - TPE
 - TPE-V
 - TPE-V
 - Silikon
- Silicone

- C** Doppelnippel (DN)
Double nipple (DN)
 - Messing, galvanisch vernickelt
- Brass, galvanic nickel-plated
 - Edelstahl (1.4305)
- Stainless steel (AISI 303)
 - Edelstahl (1.4571)
- Stainless steel (AISI 316 Ti)
 - Polycarbonat (PC)
- Polycarbonate (PC)
 - PVDF
 - PVDF

- D** O-Ring
O-ring
Bei metallischen DN
With metallic DN
 - Kautschuk (HNBR)
- Rubber (HNBR)
 - Silikon
- Silicone

- E** Kopfgewinde
Head thread
 - Standard
 - Standard
 - Erweitert
- Extended
 - Reduziert (auf Anfrage)
- Reduced (on request)

- F** Anschlussgewinde
Connection thread
 - Metrisch
- Metric
 - Pg
 - Pg
 - NPT
 - NPT
 - Zoll
- Inch
 - Standard/Lang
- Standard/long

- G** Kabel
Cable

Vorteile:

Advantages:

- 1** - Kein stehendes Wasser
- No standing water
- IP 68 bis 10 bar zum Kabel und zur Druckschraube
- IP 68 up to 10 bar to the cable and pressure screw
- 2** - Radialsymmetrisch weiche Kabelpressung
- Radially symmetrical soft cable pressing
- Großflächige Zugentlastung
- Large-area strain relief
- Keine Beschädigung des Kabels
- No damage to the cable
- 3** - Verdrehenschutz durch Rändelung am Doppelnippel (DN) und Dichteinsatz (E)
- Protection against distortion by knurling on the double nipple (DN) and sealing insert (E)
- Kein Verdrehen des Kabels bei Montage/Demontage
- No cable twisting in assembly/disassembly
- 4** - IP 54 durch Membrane am Dichteinsatz ohne Anziehen der Druckschraube (DS)
- IP 54 through diaphragms on the sealing insert without the pressure screw (DS) tightened up
- 5** - Nutgeführter O-Ring sichert Abdichtung zur Gehäusewandung
- Groove-guided o-ring secures sealing to the housing wall
- 6**  Kennzeichnung unserer Qualität: zwölf Riefen – das PFLITSCH-Warenzeichen
- Marking of our quality: Twelve grooves – the PFLITSCH trademark
- 7** - Farbcodierung der TPE-Dichteinsätze (E), dadurch direkte Zuordnung und Überprüfung der Dichteinsätze zu den verwendeten Kabeldurchmessern
- Colour coding of the TPE sealing inserts (E), thereby enabling direct assignment and checking of the sealing inserts for the cable diameters used



UNI-Farbcode (FC) für TPE-Dichteinsätze

UNI colour code (CC) for TPE sealing inserts

	Farbcode FC Colour code CC	Dichtbereich Sealing range max./min. Ø	Anschlussgewinde Connection thread
	Gelb Yellow	(ge) 6,5 – 4,0	M10, M12, M16, M20, M25 Pg 7, Pg 9, Pg 11, Pg 13,5, Pg 16
	Grau Grey	(gu) 8,0 – 5,0	M12, M16, M20, M25 Pg 9, Pg 11, Pg 13,5, Pg 16
	Schwarz Black	(sw) 9,5 – 6,5	M12, M16, M20, M25 Pg 9, Pg 11, Pg 13,5, Pg 16
	Grün Green	(gr) 10,5 – 7,0	M16, M20, M25, M32 Pg 11, Pg 13,5, Pg 16, Pg 21
	Rot Red	(rt) 13,0 – 9,0	M16, M20, M25, M32 Pg 9, Pg 13,5, Pg 16, Pg 21
	Weiß White	(ws) 15,5 – 11,5	M20, M25, M32, M40 Pg 16, Pg 21, Pg 29
	Blau Blue	(bl) 18,0 – 14,0	M20, M25, M32, M40 Pg 16, Pg 21, Pg 29
	Braun Brown	(br) 20,5 – 17,0	M20, M25, M32, M40 Pg 13,5, Pg 16, Pg 21, Pg 29
	Orange Orange	(or) 25,0 – 20,0	M32, M40 Pg 16, Pg 21, Pg 29
	Hellgelb Light yellow	(hg) 28,0 – 24,0	M32, M40 Pg 16, Pg 21, Pg 29
	Anthrazit Anthracite	(an) 32,0 – 27,0	M32, M40, M50 Pg 21, Pg 29, Pg 36
	Hellblau Light blue	(hb) 34,0 – 29,0	M32, M40, M50 Pg 21, Pg 29, Pg 36
	Rosa Pink	(rs) 36,0 – 32,0	M32, M40, M50 Pg 21, Pg 29, Pg 36
	Weiß White	(ws) 40,0 – 36,0	M50 Pg 36, Pg 42
	Weiß White	(ws) 44,0 – 39,0	M63 Pg 48

UNI Dicht Pg-Kabelverschraubung

UNI Dicht Pg cable gland



Abb. 1
Fig. 1



Abb. 2
Fig. 2

Messing vernickelt
Pg-Anschlussgewinde
Mit O-Ring HNBR
Schutzart IP 68 bis 10 bar
Zugentlastung bis Klasse A, EN 62444

Brass, nickel-plated
Pg connection thread
With o-ring HNBR
Type of protection IP 68 up to 10 bar
Strain relief up to class A, EN 62444

i Gewinde-Varianten: Standard-Maß D = Art.-Nr. 15...
Thread variants: 15 mm Länge = Art.-Nr. 18...
Standard size D = art. no. 15...
15 mm length = art. no. 18...

Werkstoff Verschraubungskörper Material gland body	Ausführung/Farbe Version/colour	Werkstoff Dichteinsatz Material sealing insert	Farbe Colour	Bestellschlüssel Art. no. supplement	Temperaturbereich min./max. Temperature range (min./max.)
Messing Brass	Vernickelt Nickel-plated	TPE	s. FC s. CC	d	-40 °C / +130 °C
Messing Brass	Vernickelt Nickel-plated	TPE-V	Natur Natural	p	-40 °C / +135 °C
Messing Brass	Vernickelt Nickel-plated	Silikon HT Silicone HT	Schwarz Black	H	-55 °C / +200 °C



Abb. 3
Fig. 3



Abb. 4 – Ausführung lang/D = 15 mm
Fig. 4 – Longer execution/D = 15 mm

Anschlussgewinde/-länge Connection thread/length		Art.-Nr. Art. no.	Dichtbereich Sealing range	Bauhöhe Mounting height	Schlüsselweite Spanner width		
Ausführung bitte ergänzen Please complete product details							
A	D mm	TPE = d TPE-V = p Silikon HT/Silicone HT = H	max./min. Ø mm	C mm	SW x E mm		
Pg 7	5,0	149	7	6,5– 4,0	20,0	14x15,5	50
Pg 9	6,0	150	7	6,5– 4,0	20,0	17x18,9	50
		150	8	8,0– 5,0	20,0	17x18,9	50
		150	9	9,5– 6,5	20,0	17x18,9	50
Pg 11	6,0	151	7	6,5– 4,0	20,0	20x22,2	50
		151	8	8,0– 5,0	20,0	20x22,2	50
		151	9	9,5– 6,5	20,0	20x22,2	50
		151	11	10,5– 7,0	20,0	20x22,2	50
Pg 13,5	6,5	152	7	6,5– 4,0	21,0	22x24,4	50
		152	8	8,0– 5,0	21,0	22x24,4	50
		152	9	9,5– 6,5	21,0	22x24,4	50
		152	11	10,5– 7,0	21,0	22x24,4	50
		152	13	13,0– 9,0	21,0	22x24,4	50
Pg 16	6,5	153	7	6,5– 4,0	21,0	24x26,7	50
		153	8	8,0– 5,0	21,0	24x26,7	50
		153	9	9,5– 6,5	21,0	24x26,7	50
		153	11	10,5– 7,0	21,0	24x26,7	50
		153	13	13,0– 9,0	21,0	24x26,7	50
Pg 21	7,0	154	11	10,5– 7,0	25,0	30x33,5	25
		154	13	13,0– 9,0	25,0	30x33,5	25
		154	16	15,5– 11,5	25,0	30x33,5	25
		154	18	18,0– 14,0	25,0	30x33,5	25
		154	20	20,5– 17,0	25,0	30x33,5	25
Pg 29	8,0	155	13 *	13,0– 9,0	28,0	40x43,5	10
		155	16	15,5– 11,5	28,0	40x43,5	10
		155	18	18,0– 14,0	28,0	40x43,5	10
		155	20	20,5– 17,0	28,0	40x43,5	10
		155	25	25,0– 20,0	28,0	40x43,5	10
		155	28	28,0– 24,0	28,0	40x43,5	10
Pg 36	9,0	156	32	32,0– 27,0	28,0	50x54	10
		156	34	34,0– 29,0	28,0	50x54	10
		156	36	36,0– 32,0	28,0	50x54	10
Pg 42	10,0	157	36 *	36,0– 32,0	30,0	57x61	5
		157	40 *	40,0– 36,0	30,0	57x61	5
Pg 48	10,0	158	44 *	44,0– 39,0	30,0	64x69	5

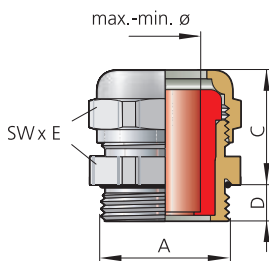
* Dichteinsatz aus Silikon HT nicht lieferbar
* Sealing insert silicone HT not available

i Passende Gegenmuttern ab Seite 442
Corresponding locknuts see from page 442

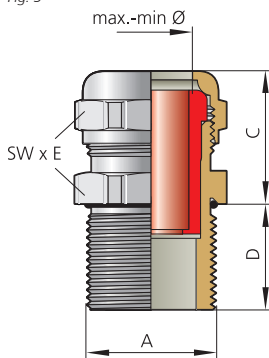
UNI Dicht Pg-Kabelverschraubung

UNI Dicht Pg cable gland



Abb. 1
Fig. 1



Abb. 2
Fig. 2

Edelstahl 1.4305
Pg-Anschlussgewinde
Mit O-Ring Silikon
Schutzart IP 68 bis 10 bar
Zugentlastung bis Klasse A, EN 62444

Stainless steel AISI 303
Pg connection thread
With o-ring silicone
Type of protection IP 68 up to 10 bar
Strain relief up to class A, EN 62444

i Anschlussgewinde mit 15 mm Länge auf Anfrage
Long connection thread 15 mm on request

Werkstoff Verschraubungskörper <i>Material gland body</i>	Ausführung/Farbe <i>Version/colour</i>	Werkstoff Dichteinsatz <i>Material sealing insert</i>	Farbe <i>Colour</i>	Bestellschlüssel <i>Art. no. supplement</i>	Temperaturbereich min./max. <i>Temperature range (min./max.)</i>
VA 1.4305 AISI 303	Blank	TPE	s. FC s. CC		-40 °C / +130 °C
VA 1.4305 AISI 303	Blank	TPE-V	Natur <i>Natural</i>	p	-40 °C / +135 °C
VA 1.4305 AISI 303	Blank	Silikon HT <i>Silicone HT</i>	Schwarz <i>Black</i>	H	-55 °C / +200 °C



Abb. 3
Fig. 3

Anschlussgewinde/-länge <i>Connection thread/length</i>		Art.-Nr. <i>Art. no.</i>	Dichtbereich <i>Sealing range</i>	Bauhöhe <i>Mounting height</i>	Schlüsselweite <i>Spanner width</i>	
Ausführung bitte ergänzen <i>Please complete product details</i>						
A	D mm	TPE = TPE-V = p Silikon HT/Silicone HT = H	max./min. ø mm	C mm	SW x E mm	
Pg 7	5,0	149st	7	6,5 – 4,0	20,0	14x15,5
Pg 9	6,0	150st	7	6,5 – 4,0	20,0	17x18,9
		150st	8	8,0 – 5,0	20,0	17x18,9
Pg 11	6,0	150st	9	9,5 – 6,5	20,0	17x18,9
		151st	7	6,5 – 4,0	20,0	22x24,4
		151st	8 *	8,0 – 5,0	20,0	22x24,4
		151st	9	9,5 – 6,5	20,0	22x24,4
Pg 13,5	6,5	151st	11	10,5 – 7,0	20,0	22x24,4
		152st	7	6,5 – 4,0	21,0	22x24,4
		152st	8	8,0 – 5,0	21,0	22x24,4
		152st	9	9,5 – 6,5	21,0	22x24,4
		152st	11	10,5 – 7,0	21,0	22x24,4
Pg 16	6,5	152st	13	13,0 – 9,0	21,0	22x24,4
		153st	7	6,5 – 4,0	21,0	24x26,7
		153st	8	8,0 – 5,0	21,0	24x26,7
		153st	9	9,5 – 6,5	21,0	24x26,7
		153st	11	10,5 – 7,0	21,0	24x26,7
Pg 21	7,0	153st	13	13,0 – 9,0	21,0	24x26,7
		153st	16	15,5 – 11,5	21,0	24x26,7
		154st	11	10,5 – 7,0	26,0	30x33,5
		154st	13	13,0 – 9,0	26,0	30x33,5
		154st	16	15,5 – 11,5	26,0	30x33,5
Pg 29	8,0	154st	18	18,0 – 14,0	26,0	30x33,5
		154st	20	20,5 – 17,0	26,0	30x33,5
		155st	13 *	13,0 – 9,0	28,0	41x44,5
		155st	16	15,5 – 11,5	28,0	41x44,5
		155st	18	18,0 – 14,0	28,0	41x44,5
Pg 36	9,0	155st	20	20,5 – 17,0	28,0	41x44,5
		155st	25	25,0 – 20,0	28,0	41x44,5
		155st	28	28,0 – 24,0	28,0	41x44,5
Pg 42	10,0	156st	32	32,0 – 27,0	28,0	50x54
		156st	34	34,0 – 29,0	28,0	50x54
		156st	36	36,0 – 32,0	28,0	50x54
Pg 48	10,0	157st	36 *	36,0 – 32,0	30,0	60x65
		157st	40 *	40,0 – 36,0	30,0	60x65
		158st	44 *	44,0 – 39,0	30,0	65x70

* Dichteinsatz aus Silikon HT nicht lieferbar
 * Sealing insert silicone HT not available

i Passende Gegenmuttern ab Seite 442
Corresponding locknuts see from page 442

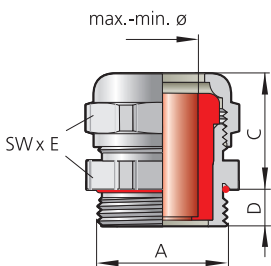
UNI Dicht Pg-Kabelverschraubung

UNI Dicht Pg cable gland



Abb. 1
Fig. 1



Abb. 2
Fig. 2

Edelstahl 1.4571
Pg-Anschlussgewinde
Mit O-Ring Silikon
Schutzart IP 68 bis 10 bar
Zugentlastung bis Klasse A, EN 62444

Stainless steel AISI 316Ti
Pg connection thread
With o-ring silicone
Type of protection IP 68 up to 10 bar
Strain relief up to class A, EN 62444

i Anschlussgewinde mit 15 mm Länge auf Anfrage
Long connection thread 15 mm on request

Werkstoff Verschraubungskörper <i>Material gland body</i>	Ausführung/Farbe <i>Version/colour</i>	Werkstoff Dichteinsatz <i>Material sealing insert</i>	Farbe <i>Colour</i>	Bestellschlüssel <i>Art. no. supplement</i>	Temperaturbereich min./max. <i>Temperature range (min./max.)</i>
VA 1.4571 AISI 316Ti	Blank	TPE	s. FC s. CC		-40 °C / +130 °C
VA 1.4571 AISI 316Ti	Blank	TPE-V	Natur Natural	p	-40 °C / +135 °C
VA 1.4571 AISI 316Ti	Blank	Silikon HT Silicone HT	Schwarz Black	H	-55 °C / +200 °C



Abb. 3
Fig. 3

Anschlussgewinde/-länge <i>Connection thread/length</i>		Art.-Nr. <i>Art. no.</i>	Dichtbereich <i>Sealing range</i>	Bauhöhe <i>Mounting height</i>	Schlüsselweite <i>Spanner width</i>	
Ausführung bitte ergänzen <i>Please complete product details</i>						
A	D mm	TPE = TPE-V = p Silikon HT/Silicone HT = H	max./min. ø mm	C mm	SW x E mm	
Pg 7	5,0	149st	7 V4A	6,5 – 4,0	20,0	14x15,5 50
Pg 9	6,0	150st	7 V4A	6,5 – 4,0	20,0	17x18,9 50
		150st	8 V4A	8,0 – 5,0	20,0	17x18,9 50
		150st	9 V4A	9,5 – 6,5	20,0	17x18,9 50
Pg 11	6,0	151st	7 V4A	6,5 – 4,0	20,0	22x24,4 50
		151st	9 V4A	8,0 – 5,0	20,0	22x24,4 50
		151st	9 V4A	9,5 – 6,5	20,0	22x24,4 50
		151st	11V4A	10,5 – 7,0	20,0	22x24,4 50
Pg 13,5	6,5	152st	7 V4A	6,5 – 4,0	21,0	22x24,4 50
		152st	8 V4A	8,0 – 5,0	21,0	22x24,4 50
		152st	9 V4A	9,5 – 6,5	21,0	22x24,4 50
		152st	11V4A	10,5 – 7,0	21,0	22x24,4 50
		152st	13V4A	13,0 – 9,0	21,0	22x24,4 50
Pg 16	6,5	153st	7 V4A	6,5 – 4,0	21,0	24x26,7 50
		153st	8 V4A	8,0 – 5,0	21,0	24x26,7 50
		153st	9 V4A	9,5 – 6,5	21,0	24x26,7 50
		153st	11V4A	10,5 – 7,0	21,0	24x26,7 50
		153st	13V4A	13,0 – 9,0	21,0	24x26,7 50
Pg 21	7,0	154st	11V4A	10,5 – 7,0	26,0	30x33,5 25
		154st	13V4A	13,0 – 9,0	26,0	30x33,5 25
		154st	16V4A	15,5 – 11,5	26,0	30x33,5 25
		154st	18V4A	18,0 – 14,0	26,0	30x33,5 25
		154st	20V4A	20,5 – 17,0	26,0	30x33,5 25
Pg 29	8,0	155st	13V4A *	13,0 – 9,0	28,0	41x44,5 10
		155st	16V4A	15,5 – 11,5	28,0	41x44,5 10
		155st	18V4A	18,0 – 14,0	28,0	41x44,5 10
		155st	20V4A	20,5 – 17,0	28,0	41x44,5 10
		155st	25V4A	25,0 – 20,0	28,0	41x44,5 10
Pg 36	9,0	156st	28V4A	28,0 – 24,0	28,0	41x44,5 10
		156st	32V4A	32,0 – 27,0	28,0	50x54 10
		156st	34V4A	34,0 – 29,0	28,0	50x54 10
		156st	36V4A	36,0 – 32,0	28,0	50x54 10
		Pg 42	10,0	157st	36V4A *	36,0 – 32,0
157st	40V4A *			40,0 – 36,0	30,0	60x65 5
Pg 48	10,0	158st	44V4A *	44,0 – 39,0	30,0	65x70 5

* Dichteinsatz aus Silikon HT nicht lieferbar
* Sealing insert silicone HT not available

i Passende Gegenmuttern ab Seite 442
Corresponding locknuts see from page 442

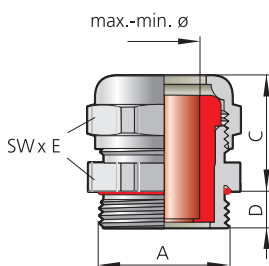
UNI Dicht Pg-Kabelverschraubung

UNI Dicht Pg cable gland



Abb. 1
Fig. 1

Abb. 2
Fig. 2

Polycarbonat, Farbe: grau (RAL 7035), schwarz (RAL 9005)
Pg-Anschlussgewinde
Schutzart IP 68 bis 10 bar

Polycarbonate, colour: grey (RAL 7035), black (RAL 9005)
Pg connection thread
Type of protection IP 68 up to 10 bar

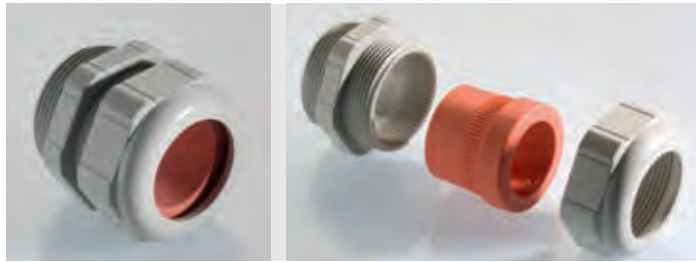
i **Passende Gegenmuttern ab Seite 442**
Corresponding locknuts see from page 442

Werkstoff Verschraubungskörper Material gland body	Ausführung/Farbe Version/colour	Bestellschlüssel Art. no. supplement	Werkstoff Dichteinsatz Material sealing insert	Farbe Colour	Bestellschlüssel Art. no. supplement	Temperaturbereich min./max. Temperature range (min./max.)
PC	Grau Grey	PC	TPE	s. FC s. CC		-20 °C / +100 °C
PC	Grau Grey	PC	TPE-V	Natur Natural	p	-20 °C / +100 °C
PC	Grau Grey	PC	Silikon HT Silicone HT	Schwarz Black	H	-20 °C / +100 °C
PC	Schwarz Black	PCn	TPE	s. FC s. CC		-20 °C / +100 °C
PC	Schwarz Black	PCn	TPE-V	Natur Natural	p	-20 °C / +100 °C
PC	Schwarz Black	PCn	Silikon HT Silicone HT	Schwarz Black	H	-20 °C / +100 °C



Abb. 3
Fig. 3

Anschlussgewinde/-länge Connection thread/length		Art.-Nr. Art. no.	Dichtbereich Sealing range	Bauhöhe Mounting height	Schlüsselweite Spanner width
Ausführung bitte ergänzen Please complete product details					
A	D mm	Grau/Grey = PC Schwarz/Black = PCn	p = TPE H = TPE-V H = Silikon HT/Silicone HT	max./min. ø mm	C mm
					SW x E mm
Pg 7	8,0	149	7	6,5 – 4,0	23,0
Pg 9	9,0	150	7	6,5 – 4,0	23,0
		150	8	8,0 – 5,0	23,0
		150	9	9,5 – 6,5	23,0
Pg 11	9,0	151	7	6,5 – 4,0	24,0
		151	8 *	8,0 – 5,0	24,0
		151	9	9,5 – 6,5	24,0
		151	11	10,5 – 7,0	24,0
Pg 13,5	9,0	152	7	6,5 – 4,0	24,0
		152	8	8,0 – 5,0	24,0
		152	9	9,5 – 6,5	24,0
		152	11	10,5 – 7,0	24,0
		152	13	13,0 – 9,0	24,0
Pg 16	9,0	153	7	6,5 – 4,0	24,0
		153	8	8,0 – 5,0	24,0
		153	9	9,5 – 6,5	24,0
		153	11	10,5 – 7,0	24,0
		153	13	13,0 – 9,0	24,0
		153	16	15,5 – 11,5	24,0
Pg 21	11,0	154	11	10,5 – 7,0	29,0
		154	13	13,0 – 9,0	29,0
		154	16	15,5 – 11,5	29,0
		154	18	18,0 – 14,0	29,0
		154	20	20,5 – 17,0	29,0
Pg 29	11,0	155	13 *	13,0 – 9,0	33,0
		155	16	15,5 – 11,5	33,0
		155	18	18,0 – 14,0	33,0
		155	20	20,5 – 17,0	33,0
		155	25	25,0 – 20,0	33,0
		155	28	28,0 – 24,0	33,0
Pg 36	14,0	156	32	32,0 – 27,0	33,0
		156	34	34,0 – 29,0	33,0
		156	36	36,0 – 32,0	33,0

* Dichteinsatz aus Silikon HT nicht lieferbar
* Sealing insert silicone HT not available

i **Schutzart IP 68 ausschließlich in Verbindung mit separat erhältlicher Flachdichtung auf Seite 468**
Type of protection IP 68 only in combination with separately available flat sealing ring on page 468

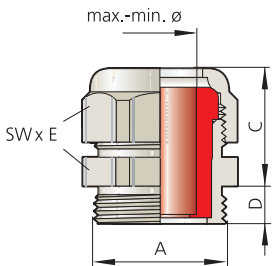
UNI Dicht Pg-Kabelverschraubung

UNI Dicht Pg cable gland



Abb. 1
Fig. 1



Abb. 2
Fig. 2

PVDF, Farbe: transparent, blau (RAL 5015), schwarz (RAL 9005)
Pg-Anschlussgewinde
Schutzart IP 68 bis 10 bar
Zugentlastung bis Klasse A, EN 62444

PVDF, colour: transparent, blue (RAL 5015), black (RAL 9005)
Pg connection thread
Type of protection IP 68 up to 10 bar
Strain relief up to class A, EN 62444

i Anschlussgewinde mit 15 mm Länge auf Anfrage
 Long connection thread 15 mm on request

Werkstoff Verschraubungskörper Material gland body	Ausführung/Farbe Version/colour	Bestellschlüssel Art. no. supplement	Werkstoff Dichteinsatz Material sealing insert	Farbe Colour	Bestellschlüssel Art. no. supplement	Temperaturbereich min./max. Temperature range (min./max.)
PVDF	Transparent		TPE	s. FC s. CC		-40 °C / +130 °C
PVDF	Transparent		TPE-V	Natur Natural	p	-40 °C / +135 °C
PVDF	Transparent		Silikon HT Silicone HT	Schwarz Black	H	-40 °C / +150 °C
PVDF	Blau Blue	a	TPE	s. FC s. CC		-40 °C / +130 °C
PVDF	Blau Blue	a	TPE-V	Natur Natural	p	-40 °C / +135 °C
PVDF	Blau Blue	a	Silikon HT Silicone HT	Schwarz Black	H	-40 °C / +150 °C
PVDF	Schwarz Black	n	TPE	s. FC s. CC		-40 °C / +130 °C
PVDF	Schwarz Black	n	TPE-V	Natur Natural	p	-40 °C / +135 °C
PVDF	Schwarz Black	n	Silikon HT Silicone HT	Schwarz Black	H	-40 °C / +150 °C



Abb. 3
Fig. 3

Anschlussgewinde/-länge Connection thread/length		Art.-Nr. Art. no.	Dichtbereich Sealing range	Bauhöhe Mounting height	Schlüsselweite Spanner width	
Ausführung bitte ergänzen Please complete product details						
A	D mm	Transparent = a	= TPE	max./min. ø mm	C mm	SW x E mm
		Blau/Blue = a	p = TPE-V			
		Schwarz/Black = n	H = Silikon HT/Silicone HT			
Pg 7	8,0	149y	7	6,5– 4,0	23,0	15x16,5 50
Pg 9	8,0	150y	7	6,5– 4,0	24,0	19x21,2 50
		150y	8	8,0– 5,0	24,0	19x21,2 50
		150y	9	9,5– 6,5	24,0	19x21,2 50
Pg 11	8,0	151y	7	6,5– 4,0	24,0	22x24,4 50
		151y	8 *	8,0– 5,0	24,0	22x24,4 50
		151y	9	9,5– 6,5	24,0	22x24,4 50
		151y	11	10,5– 7,0	24,0	22x24,4 50
Pg 13,5	9,0	152y	7	6,5– 4,0	26,0	24x26,5 50
		152y	8	8,0– 5,0	26,0	24x26,5 50
		152y	9	9,5– 6,5	26,0	24x26,5 50
		152y	11	10,5– 7,0	26,0	24x26,5 50
		152y	13	13,0– 9,0	26,0	24x26,5 50
Pg 16	9,0	153y	7	6,5– 4,0	26,0	27x29,5 50
		153y	8	8,0– 5,0	26,0	27x29,5 50
		153y	9	9,5– 6,5	26,0	27x29,5 50
		153y	11	10,5– 7,0	26,0	27x29,5 50
		153y	13	13,0– 9,0	26,0	27x29,5 50
		153y	16	15,5– 11,5	26,0	27x29,5 50
Pg 21	11,0	154y	11	10,5– 7,0	29,0	33x36,5 25
		154y	13	13,0– 9,0	29,0	33x36,5 25
		154y	16	15,5– 11,5	29,0	33x36,5 25
		154y	18	18,0– 14,0	29,0	33x36,5 25
		154y	20	20,5– 17,0	29,0	33x36,5 25

* Dichteinsatz aus Silikon HT nicht lieferbar
 * Sealing insert silicone HT not available

Fortsetzung auf der nächsten Seite
 Continued on next page

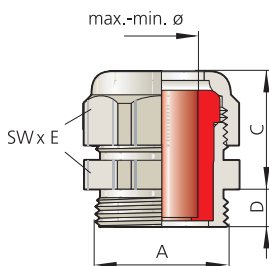
UNI Dicht Pg-Kabelverschraubung

UNI Dicht Pg cable gland

Fortsetzung von vorheriger Seite
Continued from previous page

Anschlussgewinde/-länge Connection thread/length		Art.-Nr. Art. no.	Dichtbereich Sealing range	Bauhöhe Mounting height	Schlüsselweite Spanner width		
		Ausführung bitte ergänzen Please complete product details					
A	D mm	Transparent =	a = TPE	max./min. ø mm	C mm	SW x E mm	
		Blau/Blue =	p = TPE-V				
		Schwarz/Black =	n H = Silikon HT/Silicone HT				
Pg 29	10,5	155y	13 *	13,0 – 9,0	33,0	43x46,5	10
		155y	16	15,5 – 11,5	33,0	43x46,5	10
		155y	18	18,0 – 14,0	33,0	43x46,5	10
		155y	20	20,5 – 17,0	33,0	43x46,5	10
		155y	25	25,0 – 20,0	33,0	43x46,5	10
		155y	28	28,0 – 24,0	33,0	43x46,5	10
Pg 36	13,0	156y	32	32,0 – 27,0	34,0	53x57	5
		156y	34	34,0 – 29,0	34,0	53x57	5
		156y	36	36,0 – 32,0	34,0	53x57	5
Pg 42	13,0	157y	36 * **	36,0 – 32,0	38,0	60x65	5
		157y	40 * **	40,0 – 36,0	38,0	60x65	5
Pg 48	14,0	158y	44 * **	44,0 – 39,0	41,0	65x70	5

* Dichteinsatz aus Silikon HT nicht lieferbar ** Werkstoff POM (Farbe weiß), Temperaturbereich: -40 °C bis +110 °C. Es besteht keine CSA-Zulassung.
* Sealing insert silicone HT not available ** Material POM (white colour), temperature range: -40 °C up to +110 °C, no CSA approval

i Schutzart IP 68 ausschließlich in Verbindung mit separat erhältlicher Flachdichtung auf Seite 468
Type of protection IP 68 only in combination with separately available flat sealing ring on page 468

14000 | TT0510

UNI Dicht Erweitert – Pg

UNI Dicht Extended – Pg



1

Abb. 1 – UNI Dicht Erweitert Messing
Fig. 1 – UNI Dicht Extended brass

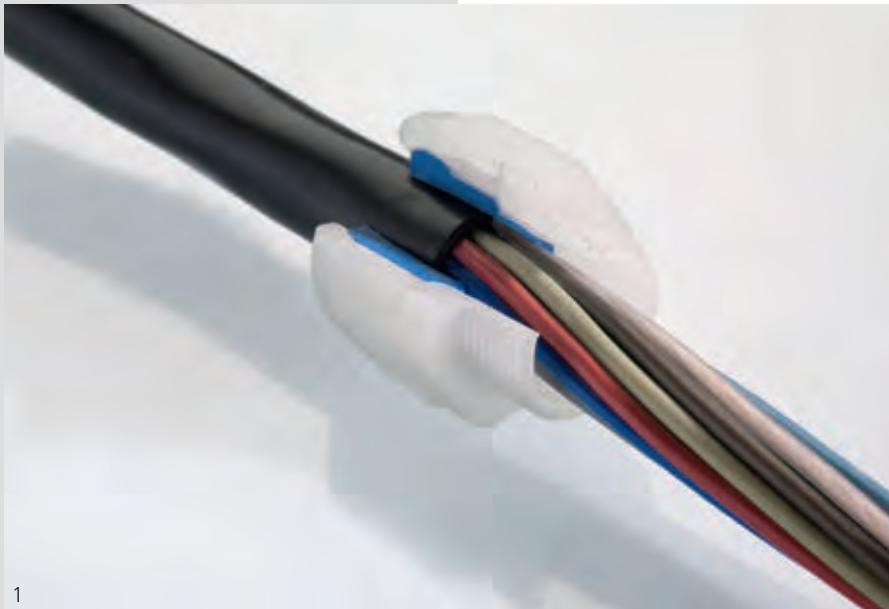

1



2

Dicke Kabel durch kleine Bohrung

Sollen Kabel mit dickerem Durchmesser durch eine bestehende Bohrung geführt werden, lässt sich das mit sogenannten „erweiterten“ Doppelnippeln einfach realisieren. Diese verfügen über ein vergrößertes Kopfteil für die Aufnahme eines entsprechend kurzen Dichtensatzes. Das abgemantelte Kabel mit seinem deutlich kleineren Adernquerschnitt wird sicher durch den Anschlussbereich der Kabelverschraubung geführt.

Thick cables through small boreholes

If a thicker cable has to be fed through an existing hole, this can be simply done with an "extended" double nipple. This has an enlarged head to accept a correspondingly short sealing insert. The unsheathed cable with its significantly smaller diameter can be fitted easily through the connection area of the cable gland.

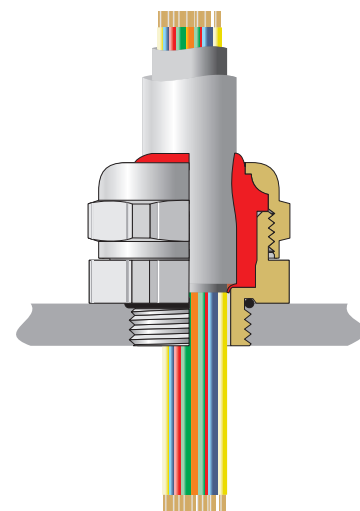

3

Abb. 1 – UNI Dicht Erweitert PVDF
Fig. 1 – UNI Dicht Extended PVDF

Abb. 2 – UNI Dicht Erweitert PVDF
Fig. 2 – UNI Dicht Extended PVDF

Abb. 3 – Querschnitt UNI Dicht Erweitert
Fig. 3 – Cross section UNI Dicht Extended

UNI Dicht Erweitert – Pg

UNI Dicht Extended – Pg



Abb. 1
Fig. 1



Abb. 2
Fig. 2

Messing vernickelt
Pg-Anschlussgewinde
Mit O-Ring HNBR
Schutzart IP 68 bis 10 bar
Zugentlastung bis Klasse A, EN 62444

Brass, nickel-plated
Pg connection thread
With o-ring HNBR
Type of protection IP 68 up to 10 bar
Strain relief up to class A, EN 62444

i Achtung: Dichteinsätze mit kurzer Bauform Art.-Nr.: Ek... verwenden
Note: Only use short sealing inserts art. no.: Ek...

Werkstoff Verschraubungskörper Material gland body	Ausführung/Farbe Version/colour	Werkstoff Dichteinsatz Material sealing insert	Farbe Colour	Bestellschlüssel Art. no. supplement	Temperaturbereich min./max. Temperature range (min./max.)
Messing Brass	Vernickelt Nickel-plated	TPE	s. FC s. CC	d	-40 °C / +130 °C
Messing Brass	Vernickelt Nickel-plated	TPE-V	Natur Natural	p	-40 °C / +135 °C
Messing Brass	Vernickelt Nickel-plated	Silikon HT Silicone HT	Schwarz Black	H	-55 °C / +200 °C



Abb. 3
Fig. 3

Anschlussgewinde/-länge Art.-Nr. Connection thread/length Art. no.		Dichtbereich Sealing range	Innendurchmesser Inner diameter	Durchlass Druck- Bauhöhe Opening pressure Mounting height	Schlüsselweite Spanner width			
Ausführung bitte ergänzen Please complete product details								
A	TPE = d	max./min. ø E	mm	mm	mm			
	TPE-V = p							
	Silikon HT/Silicone HT = H							
Pg 7	D 5,0	14950	8	8,0 – 5,0 9,0	10,0	20,0	17x18,9	50
		14950	9	9,5 – 6,5 9,0	10,0	20,0	17x18,9	50
		14951	11	10,5 – 7,0 9,0	11,5	21,0	20x22,2	50
Pg 7	D 5,5	14951	11	10,5 – 7,0 9,0	11,5	21,0	20x22,2	50
Pg 9	D 6,0	15051	11	10,5 – 7,0 12,0	11,5	21,0	20x22,2	50
		15052	13	13,0 – 9,0 12,0	13,5	21,0	22x24,4	50
Pg 11	D 6,0	15152	13	13,0 – 9,0 13,5	13,5	21,0	22x24,4	50
		15153	16	15,5 – 11,5 14,0	16,0	21,0	24x26,7	50
Pg 13,5	D 6,5	15253	16	15,5 – 11,5 17,0	16,0	21,0	24x26,7	50
		15254	18	18,0 – 14,0 17,0	18,5	25,0	30x33,5	25
		15254	20	20,5 – 17,0 17,0	21,0	25,0	30x33,5	25
Pg 16	D 6,5	15354	18	18,0 – 14,0 18,5	18,5	24,0	30x33,5	25
		15354	20	20,5 – 17,0 18,5	21,0	24,0	30x33,5	25
		15355	25	25,0 – 20,0 18,5	29,0	27,0	40x43,5	25
		15355	28	28,0 – 24,0 18,5	29,0	27,0	40x43,5	25
Pg 21	D 7,0	15455	25	25,0 – 20,0 24,0	29,0	27,0	40x43,5	10
		15455	28	28,0 – 24,0 24,0	29,0	27,0	40x43,5	10
		15456	32	32,0 – 27,0 24,0	38,0	28,0	50x54	5
		15456	34	34,0 – 29,0 24,0	38,0	28,0	50x54	5
		15456	36	36,0 – 32,0 24,0	38,0	28,0	50x54	5
Pg 29	D 8,0	15556	32	32,0 – 27,0 32,0	38,0	28,0	50x54	5
		15556	34	34,0 – 29,0 32,0	38,0	28,0	50x54	5
		15556	36	36,0 – 32,0 32,0	38,0	28,0	50x54	5
Pg 36	D 9,0	15657	38 *	38,0 – 33,0 42,0	42,0	30,0	57x61,5	5
		15657	40 *	40,0 – 36,0 42,0	42,0	30,0	57x61,5	5
Pg 48	D 10,0	158212	47 *	47,0 – 42,0 52,3	59,5	45,0	81x87	1
		158212	52 *	52,0 – 45,0 52,3	59,5	45,0	81x87	1
		158212	55 *	55,0 – 51,0 52,3	59,5	45,0	81x87	1
		158212	58 *	58,0 – 54,0 52,3	59,5	45,0	81x87	1
		158300	64 *	64,0 – 58,0 52,3	72,5	45,0	95x102	1
		158300	70 *	70,0 – 63,0 52,3	72,5	45,0	95x102	1

* Dichteinsatz aus Silikon HT nicht lieferbar
* Sealing insert silicone HT not available

i Passende Gegenmuttern ab Seite 442
Corresponding locknuts see from page 442

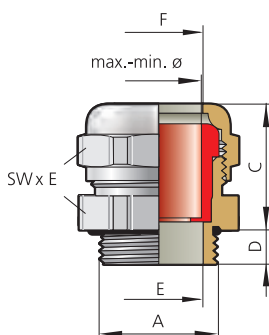
UNI Dicht Erweitert – Pg

UNI Dicht Extended – Pg



Abb. 1
Fig. 1



Abb. 2
Fig. 2

Polycarbonat, Farbe: grau (RAL 7035), schwarz (RAL 9005)
Pg-Anschlussgewinde
Schutzart IP 68 bis 10 bar
Zugentlastung bis Klasse A, EN 62444

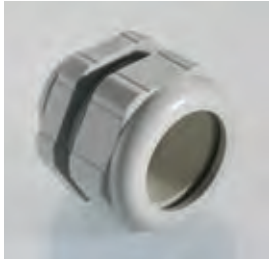
Polycarbonate, colour: grey (RAL 7035), black (RAL 9005)
 Pg connection thread
 Type of protection IP 68 up to 10 bar
 Strain relief up to class A, EN 62444

i **Achtung: Dichteinsätze mit kurzer Bauform Art.-Nr.: Ek... verwenden**
 Note: Only use short sealing inserts art. no.: Ek...

Werkstoff Verschraubungskörper Material gland body	Ausführung/Farbe Version/colour	Bestellschlüssel Art. no. supplement	Werkstoff Dichteinsatz Material sealing insert	Farbe Colour	Bestellschlüssel Art. no. supplement	Temperaturbereich min./max. Temperature range (min./max.)
PC	Grau Grey		TPE	s. FC s. CC		-20 °C / +100 °C
PC	Grau Grey		TPE-V	Natur Natural	p	-20 °C / +100 °C
PC	Grau Grey		Silikon HT Silicone HT	Schwarz Black	H	-20 °C / +100 °C
PC	Schwarz Black	n	TPE	s. FC s. CC		-20 °C / +100 °C
PC	Schwarz Black	n	TPE-V	Natur Natural	p	-20 °C / +100 °C
PC	Schwarz Black	n	Silikon HT Silicone HT	Schwarz Black	H	-20 °C / +100 °C



Abb. 3
Fig. 3

Anschlussgewinde/-länge Connection thread/length	Art.-Nr. Art. no.	Dichtbereich Sealing range	Innendurchmesser Inner diameter	Durchlass Druckschraube max. Opening pressure screw max.	Bauhöhe Mounting height	Schlüsselweite Spanner width		
	Ausführung bitte ergänzen Please complete product details							
A	D	Grau/Grey = p Schwarz/Black = n	= TPE = TPE-V = Silikon HT/ = Silicone HT	max./min. ø	E	F	C	SW x E
	mm		mm	mm	mm	mm	mm	mm
Pg 7	8,0	14950PC	8	8,0 – 5,0	8,5	10,0	22,0	19x21,2 50
		14950PC	9	9,5 – 6,5	8,5	10,0	22,0	19x21,2 50
Pg 9	8,0	15051PC	11	10,5 – 7,0	11,5	11,0	23,0	22x24,5 50
Pg 11	8,0	15152PC	13	13,0 – 9,0	14,5	13,0	24,0	24x26,5 50
Pg 13,5	8,5	15253PC	16	15,5 – 11,5	16,4	16,0	24,0	27x29,5 50
Pg 13,5	9,0	15254PC	18	18,0 – 14,0	16,4	21,0	29,0	33x36,5 25
		15254PC	20	20,5 – 17,0	16,4	21,0	29,0	33x36,5 25
Pg 16	9,0	15354PC	18	18,0 – 14,0	17,2	21,0	30,0	33x36,5 25
		15354PC	20	20,5 – 17,0	17,2	21,0	30,0	33x36,5 25
Pg 21	11,0	15455PC	25	25,0 – 20,0	23,0	28,0	34,0	43x46,5 10
		15455PC	28	28,0 – 24,0	23,0	28,0	34,0	43x46,5 10
Pg 29	11,0	15556PC	32	32,0 – 27,0	31,5	37,0	35,0	53x57 5
		15556PC	34	34,0 – 29,0	31,5	37,0	35,0	53x57 5
		15556PC	36	36,0 – 32,0	31,5	37,0	35,0	53x57 5

i **Passende Gegenmuttern ab Seite 442**
 Corresponding locknuts see from page 442

i **Schutzart IP 68 ausschließlich in Verbindung mit separat erhältlicher Flachdichtung auf Seite 468**
 Type of protection IP 68 only in combination with separately available flat sealing ring on page 468

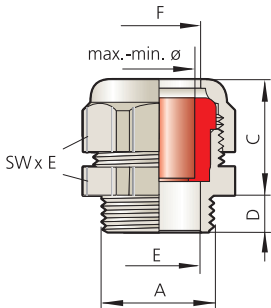
UNI Dicht Erweitert – Pg

UNI Dicht Extended – Pg



Abb. 1
Fig. 1



Abb. 2
Fig. 2

**PVDF, Farbe: transparent, blau (RAL 5015), schwarz (RAL 9005)
Pg-Anschlussgewinde
Schutzart IP 68 bis 10 bar
Zugentlastung bis Klasse A, EN 62444**

*PVDF, colour: transparent, blue (RAL 5015), black (RAL 9005)
Pg connection thread
Type of protection IP 68 up to 10 bar
Strain relief up to class A, EN 62444*

i Achtung: Dichteinsätze mit kurzer Bauform Art.-Nr.: Ek... verwenden
Note: Only use short sealing inserts art. no.: Ek...

Werkstoff Verschraubungskörper <i>Material gland body</i>	Ausführung/Farbe <i>Version/colour</i>	Bestellschlüssel <i>Art. no. supplement</i>	Werkstoff Dichteinsatz <i>Material sealing insert</i>	Farbe <i>Colour</i>	Bestellschlüssel <i>Art. no. supplement</i>	Temperaturbereich min./max. <i>Temperature range (min./max.)</i>
PVDF	Transparent		TPE	s. FC s. CC		-40 °C / +130 °C
PVDF	Transparent		TPE-V	Natur <i>Natural</i>	p	-40 °C / +135 °C
PVDF	Transparent		Silikon HT <i>Silicone HT</i>	Schwarz <i>Black</i>	H	-40 °C / +150 °C
PVDF	Blau <i>Blue</i>	a	TPE	s. FC s. CC		-40 °C / +130 °C
PVDF	Blau <i>Blue</i>	a	TPE-V	Natur <i>Natural</i>	p	-40 °C / +135 °C
PVDF	Blau <i>Blue</i>	a	Silikon HT <i>Silicone HT</i>	Schwarz <i>Black</i>	H	-40 °C / +150 °C
PVDF	Schwarz <i>Black</i>	n	TPE	s. FC s. CC		-40 °C / +130 °C
PVDF	Schwarz <i>Black</i>	n	TPE-V	Natur <i>Natural</i>	p	-40 °C / +135 °C
PVDF	Schwarz <i>Black</i>	n	Silikon HT <i>Silicone HT</i>	Schwarz <i>Black</i>	H	-40 °C / +150 °C



Abb. 3
Fig. 3

Anschlussgewinde/-länge <i>Connection thread/length</i>	Art.-Nr. <i>Art. no.</i>	Dichtbereich <i>Sealing range</i>	Innendurchmesser <i>Inner diameter</i>	Durchlassdruckschraube max. <i>Opening pressure screw max.</i>	Bauhöhe <i>Mounting height</i>	Schlüsselweite <i>Spanner width</i>			
Ausführung bitte ergänzen <i>Please complete product details</i>									
A	D	max./min. ø	E	F	C	SW x E			
	mm	mm	mm	mm	mm	mm			
Pg 7	8,0	14950y	8	8,0– 5,0	8,5	10,0	23,0	19x21,2	50
		14950y	9	9,5– 6,5	8,5	10,0	23,0	19x21,2	50
Pg 9	8,0	15051y	11	10,5– 7,0	11,5	11,0	23,0	22x24,5	50
	8,5	15052y	13	13,0– 9,0	11,5	13,0	26,0	26,5x26,5	50
		15052y	13	13,0– 9,0	11,5	13,0	26,0	24x26,5	50
Pg 11	8,0	15152y	13	13,0– 9,0	14,2	13,0	26,0	24x26,5	50
Pg 11	9,0	15153y	16	15,5– 11,5	14,2	16,0	27,0	27x29,5	50
Pg 13,5	8,5	15253y	16	15,5– 11,5	16,4	16,0	27,0	27x29,5	50
	9,0	15254y	18	18,0– 14,0	16,4	21,0	30,0	33x36,5	50
		15254y	20	20,5– 17,0	16,4	21,0	30,0	33x36,5	25
Pg 16	9,0	15354y	18	18,0– 14,0	17,2	21,0	30,0	33x36,5	25
		15354y	20	20,5– 17,0	17,2	21,0	30,0	33x36,5	25
Pg 16	10,0	15355y	25	25,0– 20,0	22,0	28,0	32,0	43x46,5	10
		15355y	28	28,0– 24,0	22,0	28,0	32,0	43x46,5	10
Pg 21	10,0	15456y	32	32,0– 27,0	28,0	37,0	35,0	53x57	5
		15456y	34	34,0– 29,0	28,0	37,0	35,0	53x57	5
		15456y	36	36,0– 32,0	28,0	37,0	35,0	53x57	5
Pg 21	11,0	15455y	25	25,0– 20,0	23,0	28,0	33,0	43x46,5	10
		15455y	28	28,0– 24,0	23,0	28,0	33,0	43x46,5	10
Pg 29	11,0	15556y	32	32,0– 27,0	31,5	37,0	35,0	53x57	5
		15556y	34	34,0– 29,0	31,5	37,0	35,0	53x57	5
		15556y	36	36,0– 32,0	31,5	37,0	35,0	53x57	5

i Schutzart IP 68 ausschließlich in Verbindung mit separat erhältlicher Flachdichtung auf Seite 468
Type of protection IP 68 only in combination with separately available flat sealing ring on page 468

UNI Mehrfach – Pg

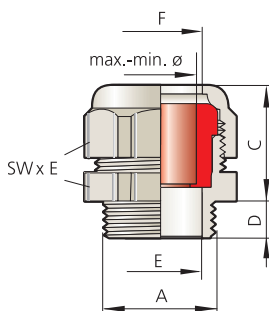
UNI Multiple – Pg



Abb. 1 – UNI Mehrfach montiert
Fig. 1 – Assembled UNI Multiple

Abb. 2 – UNI Mehrfach und Verschlussbolzen für nicht belegte Löcher
Fig. 2 – UNI Multiple and bolt for unused holes

Abb. 3 – UNI Mehrfach-Dichteinsätze mit unterschiedlichen Lochbildern
Fig. 3 – UNI Multiple sealing inserts with different hole patterns

Mehrere Kabel sicher durch eine Bohrung führen

Wer aus Platz- oder Handlinggründen mehrere Kabel sicher durch eine Bohrung führen möchte, ersetzt den Standard-Dichteinsatz einfach durch Typen aus dem UNI Mehrfach-Programm. Verschiedene Lochbilder stehen zur Verfügung, sodass sich auch unterschiedliche Kabeldurchmesser abdichten lassen. Dabei erreicht die UNI Mehrfach die Schutzart IP 65, wenn die Differenz von Kabeldurchmesser und Loch weniger als 10 % beträgt. Sind beide gleich, lässt sich auch IP 68 (bis 10 bar) erreichen. Dichtigkeit und Zugentlastung sind abhängig vom verwendeten Kabel. Entsprechende Tests bietet PFLITSCH im eigenen Prüflabor an.

Dichteinsätze nach Kundenwunsch

PFLITSCH fertigt diese Dichteinsätze exakt nach Kundenvorgabe aus dem hochwertigen Kunststoff TPE-V, der Einsatztemperaturen von -40 °C bis +135 °C erlaubt. Dank dieser Fertigungsmethode kann PFLITSCH selbst Prototypen und Kleinserien zu wirtschaftlichen Preisen realisieren. Alternativ kann der Kunde geschlossene Dichteinsätze selbst mit Lochungen versehen. Nicht belegte Löcher werden mit einem Verschlussbolzen abgedichtet. Neben den runden Lochungen fertigt PFLITSCH auch Varianten für unterschiedliche Flach- oder Sonderkabel, beispielsweise für den ASI-Bus oder für Kabel, die mit Trageilen ausgestattet sind.

Dichteinsätze für konfektionierte Kabel

Die Mehrfach-Dichteinsätze gibt es auch geteilt, z. B. für die Abdichtung von Kabeln, die bereits mit Steckern oder Sensoren konfektioniert sind. Diese Bauteile werden durch den Verschraubungskörper geführt, bevor die Kabel von den zwei Hälften des Dichteinsatzes zuverlässig umschlossen werden.

Für den gleichen Anwendungsfall bieten sich die seitlich geschlitzten Dichteinsätze an: Durch den nach außen offenen Schlitz lassen sich Kabel unkompliziert einführen.

Inserting several cables securely through a borehole

Users intending to thread several cables reliably through a borehole for space or handling reasons can replace the standard sealing insert with types from the UNI Multiple range. A number of hole patterns are available, so that a variety of cable diameters can also be sealed. Here UNI Multiple achieves protection class IP 65, when the difference between the cable diameter and breakthrough is less than 10%. Should the values be the same, IP 68 (up to 10 bar) can be achieved. The tightness and strain relief depend on the cable used. PFLITSCH conducts the corresponding testing in its own test laboratory.

Sealing inserts according to customer wishes

PFLITSCH manufactures these sealing inserts exactly according to customer wishes from the high-grade plastic TPE-V, permitting application temperatures from -40 °C to +135 °C. Due to this production method, PFLITSCH can realise even prototypes and short runs economically. Alternatively, with a slowly running drill customers can make their own holes in closed sealing inserts. Unused holes are sealed with a bolt. In addition to the round perforations, PFLITSCH also produces variants for different flat cables or special cables, for example, for the ASI-Bus or for cables with track cables.

Sealing inserts for ready-made cables

The multiple sealing inserts also come split, e.g. for sealing cables, already made up with connectors or sensors. These components are threaded through the gland body before the cables are reliably enclosed by the two halves of the sealing insert.

The laterally slotted sealing inserts also lend themselves to this application: Cables can be inserted through the slot open to the outside.



1



2

Abb. 1 – Geteilter Mehrfach-Dichteinsatz
Fig. 1 – Split multiple sealing insert

Abb. 2 – Kabelverschraubung für zwei ASI-Bus-Kabel
Fig. 2 – Cable gland for two ASI-Bus cables

UNI Mehrfach Pg-Kabelverschraubung

UNI Multiple Pg cable gland



Abb. 1
Fig. 1



Abb. 2
Fig. 2

Messing vernickelt, Edelstahl 1.4305, Polycarbonat, PVDF
Pg-Anschlussgewinde
Schutzart IP 65
Schutzart IP 68 bis 10 bar, wenn Kabel- \varnothing = Loch- \varnothing
Zugentlastung bis Klasse A, EN 62444

Brass, nickel-plated, stainless steel AISI 303, polycarbonate, PVDF
 Pg connection thread
 Type of protection IP 65
 Type of protection IP 68 up to 10 bar, achievable if cable \varnothing = hole \varnothing
 Strain relief up to class A, EN 62444

i **Farbvarianten für** **PC:** **PCn = schwarz**
Colour variants for **PVDF:** **ya = blau**
PC: **PCn = schwarz**
PVDF: **ya = blue**
PC: **PCn = black**
PVDF: **yn = black**

Werkstoff Verschraubungskörper	Ausführung/Farbe	Bestellschlüssel	Werkstoff Dichteinsatz	Farbe	Bestellschlüssel	Temperaturbereich min./max.
Material gland body	Version/colour	Art. no. supplement	Material sealing insert	Colour	Art. no. supplement	Temperature range (min./max.)
Messing Brass	Vernickelt Nickel-plated		TPE	Weiß White		-40 °C / +130 °C
Messing Brass	Vernickelt Nickel-plated		TPE-V	Natur Natural	p	-40 °C / +135 °C
VA 1.4305 AISI 303	Blank	st	TPE	Weiß White		-40 °C / +130 °C
VA 1.4305 AISI 303	Blank	st	TPE-V	Natur Natural	p	-40 °C / +135 °C
PC	Grau Grey	PC	TPE	Weiß White		-20 °C / +100 °C
PC	Grau Grey	PC	TPE-V	Natur Natural	p	-20 °C / +100 °C
PVDF	Transparent	y	TPE	Weiß White		-40 °C / +130 °C
PVDF	Transparent	y	TPE-V	Natur Natural	p	-40 °C / +135 °C



Abb. 3 – Beispiel „2 x 3“
 2 = Anzahl Bohrungen
 3 = Bohrungsdurchmesser in mm
 Fig. 3 – Example „2 x 3“
 2 = number of bores
 3 = bore hole diameter in mm

Anschlussgewinde	Art.-Nr.		
Connection thread	Art. no.	Ausführung bitte ergänzen Please complete product details	
		Messing/Brass =	
		VA 1.4305/AISI 303 = st	
A		PC = PC	= TPE
		PVDF = y	p = TPE-V
Pg 7	149	m1x3	50
	149	m1x4	50
	149	m1x5	50
	149	m4x1,7	50
	14950	m1x5 *	50
	14950	m2x3 *	50
	14950	m2x4 *	50
	14950	m3x3 *	50
Pg 9	150	m1x1,5S/1x4	50
	150	m1x3	50
	150	m1x4	50
	150	m1x5	50
	150	m2x1,2	50
	150	m2x3	50
	150	m2x4	50
	150	m3x3	50
	150	m3x3,5	50
	150	m4x1,4	50
	150	m4x3	50
	150	m4x3,3	50
	15051	m1x2/2x4 * **	50
	15051	m1x4/1x6 * **	50

* Dichteinsatz kurz = Art.-Nr.: Ek... ** Ausführung in Edelstahl nicht lieferbar
 * Sealing insert short = art. no.: Ek... ** Version made of stainless steel is not available

Fortsetzung auf der nächsten Seite
 Continued on next page

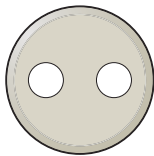
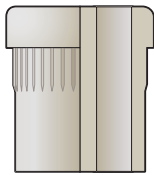
UNI Mehrfach Pg-Kabelverschraubung

UNI Multiple Pg cable gland

Fortsetzung von vorheriger Seite
Continued from previous page

Anschlussgewinde Connection thread	Art.-Nr. Art. no.	Ausführung bitte ergänzen Please complete product details			
		Messing/Brass =	VA 1.4305/AISI 303 = st		
A		PC =	TPE		
		PVDF = y p	TPE-V		
		Pg 9	15052	m1x4,7/1x6,4	50
			15052	m2x3 **	50
	15052	m2x4 **	50		
	15052	m2x5 **	50		
	15052	m2x6 **	50		
	15052	m3x5,3 **	50		
	15052	m4x4 **	50		
	15052	m8x3 **	50		
Pg 11	151	m1x3	50		
	151	m1x3/1x6	50		
	151	m1x4	50		
	151	m1x5	50		
	151	m2x2,3	50		
	151	m2x3	50		
	151	m2x4	50		
	151	m2x5	50		
	151	m2x6	50		
	151	m3x3	50		
	151	m3x4	50		
	151	m4x1,5	50		
	151	m4x2,5/1x3,5	50		
	151	m5x2,5	50		
	151	m5x3	50		
	151	m5x3,5	50		
	151	m6x2	50		
	151	m6x2,5	50		
	151	m7x1,5	50		
	151	m9x1,5	50		
	15152	m2x6 **	50		
15152	m3x4 **	50			
15152	m3x5,3 **	50			
15152	m4x4 **	50			
15152	m8x3 **	50			
Pg 13,5	152	m1x2/3x3	50		
	152	m1x2,5	50		
	152	m1x3	50		
	152	m1x3/2x6	50		
	152	m1x3,5/1x6	50		
	152	m1x3,5/2x4,5	50		
	152	m1x4	50		
	152	m1x4,7/1x6,4	50		
	152	m1x5	50		
	152	m1x8S	50		
	152	m2x3	50		

Anschlussgewinde Connection thread	Art.-Nr. Art. no.	Ausführung bitte ergänzen Please complete product details			
		Messing/Brass =	VA 1.4305/AISI 303 = st		
A		PC =	TPE		
		PVDF = y p	TPE-V		
		Pg 13,5	152	m2x4/1x5,5	50
			152	m2x5	50
	152	m2x5/1x5,5	50		
	152	m2x6	50		
	152	m3x1,9/1x6	50		
	152	m3x2	50		
	152	m3x3	50		
	152	m3x3/1x6	50		
	152	m3x4	50		
	152	m3x5,3	50		
	152	m3x5,3S	50		
	152	m4x3	50		
	152	m4x4	50		
	152	m6x2,5	50		
	152	m6x3,5	50		
	152	m7x3,3	50		
	152	m8x1,5	50		
	152	m8x2	50		
	152	m10x2	50		
	15253	m1x3/1x6/1x8 **	50		
	15253	m1x5/1x9 **	50		
	15253	m2x4 **	50		
	15253	m2x6 **	50		
	15253	m2x6/1x7 **	50		
	15253	m2x6,5 **	50		
	15253	m2x8 **	50		
	15253	m3x5/1x8 **	50		
	15253	m3x7 **	50		
	15253	m4x6 **	50		
	15253	m6x4 **	50		
Pg 16	153	m1x2,6	50		
	153	m1x3	50		
	153	m1x3/1x8	50		
	153	m1x3/1x9	50		
	153	m1x3/2x7,7	50		
	153	m1x3,3/2x3,7	50		
	153	m1x3,5	50		
	153	m1x4	50		
	153	m1x4/1x5	50		
	153	m1x4/2x6/1x7	50		
	153	m1x4/3x5	50		
	153	m1x5	50		
	153	m1x5/1x9	50		
	153	m1x5/2x6	50		

212001/1701900

* Dichteinsatz kurz = Art.-Nr.: Ek... ** Ausführung in Edelstahl nicht lieferbar
* Sealing insert short = art. no.: Ek... ** Version made of stainless steel is not available

Fortsetzung auf der nächsten Seite
Continued on next page

UNI Mehrfach Pg-Kabelverschraubung

UNI Multiple Pg cable gland

Fortsetzung von vorheriger Seite
Continued from previous page

Anschlussgewinde Art.-Nr.		Ausführung bitte ergänzen Please complete product details	
Connection thread Art. no.			
		Messing/Brass =	
		VA 1.4305/AISI 303 = st	
A		PC = PC	= TPE
		PVDF = y	p = TPE-V
Pg 16	153	m1x6/1x8	50
	153	m1x6/1x9S	50
	153	m1x8S	50
	153	m2x3,2/2x6	50
	153	m2x3,3	50
	153	m2x3,5	50
	153	m2x3,5/1x5,5	50
	153	m2x3,5/1x8,5	50
	153	m2x4	50
	153	m2x5	50
	153	m2x5/1x6	50
	153	m2x6	50
	153	m2x6/1x7	50
	153	m2x6/1x8	50
	153	m2x8	50
	153	m3x1,9/1x2,4/1x7	50
	153	m3x2,5/1x3,5/1x7	50
	153	m3x3	50
	153	m3x3/1x6	50
	153	m3x3,5	50
	153	m3x4/1x9	50
	153	m3x5/1x8	50
	153	m3x6	50
	153	m3x7	50
	153	m4x3	50
	153	m4x4	50
	153	m4x5	50
	153	m4x6	50
	153	m6x4	50
	153	m7x2	50
	153	m9x3	50
	153	m13x2,7	50
	15354	m1x4/1x12 *	25
	15354	m1x4,5/1x12 *	50
	15354	m1x4,5/2x6,5 *	50
	15354	m1x5,5/1x9 *	50
	15354	m1x5,5/1x10,5 *	25
	15354	m1x5,8/1x6,9/1x8,4 *	50
	15354	m1x6/2x9 *	50
	15354	m1x6,5/1x12 *	25
	15354	m1x6,9/1x7,4/1x8,4 *	50
	15354	m1x7/1x8,5 *	50
	15354	m1x7/1x10,5 *	50
	15354	m1x7,5/1x8,5/1x10 *	50
	15354	m1x8,5/1x12 *	25
	15354	m1x11,8 *	50

Anschlussgewinde Art.-Nr.		Ausführung bitte ergänzen Please complete product details	
Connection thread Art. no.			
		Messing/Brass =	
		VA 1.4305/AISI 303 = st	
A		PC = PC	= TPE
		PVDF = y	p = TPE-V
Pg 16	15354	m2x5/1x5,5 *	25
	15354	m2x6 *	25
	15354	m2x6/2x8 *	50
	15354	m2x6,5/1x9,5 *	25
	15354	m2x7 *	50
	15354	m2x8 *	25
	15354	m2x9 *	25
	15354	m2x10 *	25
	15354	m3x2,5/3x8 *	50
	15354	m3x7 *	50
	15354	m3x8 *	25
	15354	m3x9 *	25
	15354	m4x4,6/3x5,1 *	50
	15354	m4x5 *	50
	15354	m4x5/1x6,5 *	50
	15354	m4x6 *	50
	15354	m4x6,5 *	50
	15354	m4x7,5 *	25
	15354	m4x8 *	50
	15354	m5x5 *	25
	15354	m5x6 *	25
	15354	m6x5,5 *	50
	15354	m6x6,5 *	50
	15354	m7x4 *	25
	15354	m8x4 *	25
	15354	m12x3,5 *	50
Pg 21	154	m1x2,9/2x6/1x6,1/1x6,8/1x7,3	25
	154	m1x3,2/2x5/1x6S	25
	154	m1x3,2/2x6/1x6,1/1x6,8/1x7,3	25
	154	m1x3,2/2x6/3x7	25
	154	m1x3,2S/2x5S/1x8,5S	25
	154	m1x4/1x5/1x13	25
	154	m1x4,3/1x6/1x8	25
	154	m1x4,5/2x7/1x8	25
	154	m1x4,5/2x8	25
	154	m1x5/1x9	25
	154	m1x5,4	25
	154	m1x5,7/1x13	25
	154	m1x5,7/2x6,3/1x8,5	25
	154	m1x6/2x9	25
	154	m1x6,5/1x12	25
	154	m1x7	25
	154	m1x7/1x8,5	25
	154	m1x7/1x10,5	25
	154	m1x8,5/1x12	25

* Dichteinsatz kurz = Art.-Nr.: Ek...
* Sealing insert short = art. no.: Ek...

Fortsetzung auf der nächsten Seite
Continued on next page

UNI Mehrfach Pg-Kabelverschraubung

UNI Multiple Pg cable gland

Fortsetzung von vorheriger Seite
Continued from previous page

Anschlussgewinde Art.-Nr.		Ausführung bitte ergänzen Please complete product details	
Connection thread	Art. no.		
		Messing/Brass =	
		VA 1.4305/AISI 303 = st	
A		PC = PC	= TPE
		PVDF = y	p = TPE-V
Pg 21	154	m2x4,5	25
	154	m2x4,5/1x13	25
	154	m2x6	25
	154	m2x6/2x8	25
	154	m2x7/3x7S	25
	154	m2x7,2/1x10,5	25
	154	m2x8	25
	154	m2x9	25
	154	m3x4	25
	154	m3x5	25
	154	m3x6/1x8	25
	154	m3x6/2x8	25
	154	m3x7	25
	154	m3x8	25
	154	m3x9	25
	154	m4x4	25
	154	m4x5	25
	154	m4x5/4x5S	25
	154	m4x6	25
	154	m4x6/1x8	25
	154	m4x6/3x6S	25
	154	m4x6,5	25
	154	m4x6,5/1x6,5SB	25
	154	m4x8	25
	154	m5x4	25
	154	m5x5	25
	154	m5x6	25
	154	m6x4	25
	154	m6x4/1x7	25
	154	m6x5	25
	154	m6x5,5	25
	154	m6x6,5	25
	154	m8x3	25
	154	m8x4	25
	154	m8x4/1x4SB	25
	154	m8x5	25
	154	m8x5,5	25
	154	m9x3	25
	154	m21x2	25
	15455	m1x3,5/2x8/1x14 *	10
	15455	m1x4/1x6/1x8/2x10 *	10
	15455	m1x4/1x9,3/1x10 *	10
	15455	m1x4/2x8 *	10
	15455	m1x5/3x8,5/1x10,5 *	10
	15455	m1x5,8/1x6,9/1x11 *	10
	15455	m1x5,8/2x11 *	10

* Dichteinsatz kurz = Art.-Nr.: Ek...

* Sealing insert short = art. no.: Ek...

Anschlussgewinde Art.-Nr.		Ausführung bitte ergänzen Please complete product details	
Connection thread	Art. no.		
		Messing/Brass =	
		VA 1.4305/AISI 303 = st	
A		PC = PC	= TPE
		PVDF = y	p = TPE-V
Pg 21	15455	m1x6,5/1x17 *	10
	15455	m1x6,5/2x11,2 *	10
	15455	m1x7/1x16 *	10
	15455	m1x7,2/1x9,1/1x9,3 *	10
	15455	m1x8/1x14 *	10
	15455	m1x8/1x9/1x12 *	10
	15455	m1x8/2x11 *	10
	15455	m1x8/2x8,5/1x15 *	10
	15455	m1x9/1x10 *	10
	15455	m1x9/1x10/1x11 *	10
	15455	m1x9/1x15 *	10
	15455	m1x10/1x12 *	10
	15455	m1x10/1x13 *	10
	15455	m1x10/1x15 *	10
	15455	m1x10,5/1x16 *	10
	15455	m1x10,7/1x13,8 *	10
	15455	m2x5/1x8,6/1x12,2 *	10
	15455	m2x5/2x9 *	10
	15455	m2x5,8/1x11 *	10
	15455	m2x6/2x10 *	10
	15455	m2x8,5/1x13,5 *	10
	15455	m2x10 *	10
	15455	m2x11 *	10
	15455	m2x12 *	10
	15455	m2x13 *	10
	15455	m2x13,9 *	10
	15455	m3x9 *	10
	15455	m3x11 *	10
	15455	m4x5,5/1x8 *	10
	15455	m4x6,5 *	10
	15455	m4x8 *	10
	15455	m4x9 *	10
	15455	m4x10 *	10
	15455	m4x9S *	10
	15455	m5x8 *	10
	15455	m5x9 *	10
	15455	m5x9,5 *	10
	15455	m5x10 *	10
	15455	m6x8 *	10
	15455	m8x5,5 *	10
	15455	m10x6 *	10
	15455	m11x5,2 *	10
	15455	m12x5,3 *	10
	15455	m24x3 *	10
Pg 29	155	m1x16S	10

212000 ITTO1900

UNI Mehrfach Pg-Kabelverschraubung

UNI Multiple Pg cable gland

Fortsetzung von vorheriger Seite
Continued from previous page

Anschlussgewinde		Art.-Nr.	
Connection thread		Art. no.	
Ausführung bitte ergänzen Please complete product details			
	Messing/Brass	=	
	VA 1.4305/AISI 303	= st	
A	PC	= PC	= TPE
	PVDF	= y p	= TPE-V
Pg 29	155	m1x4/1x6/1x8/2x10	10
	155	m1x4/2x6/4x8	10
	155	m1x4/2x7/2x9	10
	155	m1x4/7x7	10
	155	m1x4,5/4x8	10
	155	m1x5/2x9/1x13	10
	155	m1x5/4x9	10
	155	m1x5,5/1x9	10
	155	m1x5,8/2x11	10
	155	m1x6/1x10	10
	155	m1x6/1x8,5/1x10,5	10
	155	m1x6/2x6,5/2x8	10
	155	m1x6/2x9	10
	155	m1x6,5/1x17	10
	155	m1x6,5/2x7,5	10
	155	m1x6SB/3x6/3x8/1x9,2	10
	155	m1x7/1x14	10
	155	m1x7/1x8,5/1x17	10
	155	m1x7/1x9,5/1x12	10
	155	m1x7/1x9/1x11	10
	155	m1x7/2x8,5	10
	155	m1x7/2x8/2x10	10
	155	m1x8/2x11	10
	155	m1x8/2x12	10
	155	m1x8/2x8,5/1x12	10
	155	m1x8/2x8,5/1x15	10
	155	m1x8/12x4	10
	155	m1x8,5/1x12	10
	155	m1x8,5/1x14	10
	155	m1x9/1x10/1x11	10
	155	m1x9/1x15	10
	155	m1x9,5/1x11,5/1x13,5	10
	155	m1x9,5/2x13,5	10
	155	m1x10/1x11,5/1x13	10
	155	m1x10/1x12/1x13,5	10
	155	m1x10/1x13	10
	155	m1x10,5/1x16	10
	155	m1x10,7/1x13,8	10
	155	m1x12/1x13	10
	155	m2x4/2x5/2x7/2x8	10
	155	m2x4,8/2x6,3	10
	155	m2x5/1x8,6/1x12,2	10
	155	m2x5,8/1x11	10
	155	m2x6/1x10,5/1x12	10
	155	m2x6/1x7,5/2x8,5	10
	155	m2x6/1x8,5	10
	155	m2x6/2x6S/1x7/1x7S/1x10	10

Anschlussgewinde		Art.-Nr.	
Connection thread		Art. no.	
Ausführung bitte ergänzen Please complete product details			
	Messing/Brass	=	
	VA 1.4305/AISI 303	= st	
A	PC	= PC	= TPE
	PVDF	= y p	= TPE-V
Pg 29	155	m2x6,5	10
	155	m2x6,5/1x10,5	10
	155	m2x7	10
	155	m2x7/1x9	10
	155	m2x8	10
	155	m2x8,5/1x13,5	10
	155	m2x8,5/2x11,5	10
	155	m2x9	10
	155	m2x9/1x13	10
	155	m2x9/1x15	10
	155	m2x10	10
	155	m2x11	10
	155	m2x12	10
	155	m2x13	10
	155	m3x3/7x4/1x8	10
	155	m3x3/8x5	10
	155	m3x3/8x5/1x8	10
	155	m3x7	10
	155	m3x7/3x8	10
	155	m3x9	10
	155	m3x9,5	10
	155	m3x11	10
	155	m3x12	10
	155	m4x3,5/2x7/1x11	10
	155	m4x5	10
	155	m4x5,5	10
	155	m4x5,5/1x8	10
	155	m4x5,7/2x10	10
	155	m4x6/3x8,5	10
	155	m4x6,5	10
	155	m4x6,5/4x6,5SB	10
	155	m4x8	10
	155	m4x9	10
	155	m4x10	10
	155	m4x11	10
	155	m5x3,5/2x5/1x6/2x6,5	10
	155	m5x8	10
	155	m5x9	10
	155	m5x10	10
	155	m6x4/3x6/1x8	10
	155	m6x6	10
	155	m6x7,4	10
	155	m6x8	10
	155	m7x4,8	10
	155	m7x6/1x11	10
	155	m7x7	10

21200 | IT01900

UNI Mehrfach Pg-Kabelverschraubung

UNI Multiple Pg cable gland

Fortsetzung von vorheriger Seite
Continued from previous page

Anschlussgewinde Art.-Nr. Connection thread Art. no.			
Ausführung bitte ergänzen Please complete product details			
	Messing/Brass	=	
	VA 1.4305/AISI 303	= st	
A	PC	= PC	= TPE
	PVDF	= y p	= TPE-V
Pg 29	155	m8x5,5	10
	155	m8x7	10
	155	m10x6	10
	155	m11x6	10
	155	m12x4/1x8	10
	155	m12x5,3	10
	155	m13x3,5/1x9,5	10
	155	m16x3,5	10
	155	m17x3,5	10
	155	m20x3,5	10
	155	m24x3	10
	15556	m1x4/1x5/2x13 *	5
	15556	m1x4/2x6/4x9 *	5
	15556	m1x4/5x10 *	5
	15556	m1x11/1x21 *	10
	15556	m1x13/1x19 *	5
	15556	m1x14/1x17 *	5
	15556	m2x15 *	10
	15556	m3x7/4x10 *	5
	15556	m4x7 *	5
	15556	m4x13 *	5
	15556	m7x9 *	5
	15556	m8x8 *	5
	15556	m8x9 *	5
	15556	m12x6,4 *	5
Pg 36	156	m1x5/1x9/1x11/1x19	5
	156	m1x5/2x6,5/1x8,5/1x11	5
	156	m1x5/3x8/1x8,5/1x9,5	5
	156	m1x8/4x12,5	5
	156	m1x9,5/2x13,5	5
	156	m1x10/3x11,5	5
	156	m1x11/1x21	5
	156	m1x11/2x13	5
	156	m1x12,5/1x16,5	5
	156	m1x13/2x16,5	5
	156	m1x14/1x17	5
	156	m1x5SB/4x7/1x14	5
	156	m2x8/3x10	5
	156	m2x9	5
	156	m2x15	5
	156	m3x10	5
	156	m3x14,5	5
	156	m4x7	5

Anschlussgewinde Art.-Nr. Connection thread Art. no.			
Ausführung bitte ergänzen Please complete product details			
	Messing/Brass	=	
	VA 1.4305/AISI 303	= st	
A	PC	= PC	= TPE
	PVDF	= y p	= TPE-V
Pg 36	156	m4x10,2	5
	156	m4x11,5	5
	156	m4x12	5
	156	m4x13	5
	156	m5x11,5	5
	156	m6x10	5
	156	m7x9	5
	156	m8x8	5
	156	m8x9	5
	156	m11x8	5
	156	m13x7	5
	156	m15x5	5
	156	m16x6	5
	15657	m1x12/1x25 * **	5
	15657	m2x17 * **	5
Pg 42	157	m1x7,5/3x11/1x13 **	5
	157	m2x17 **	5
	157	m3x6,7/1x11/1x14,5 **	5
	157	m5x11 **	5
Pg 48	158	m1x5,5/1x9/2x15,5 **	5
	158	m1x5,5/4x15,5 **	5
	158	m1x9/1x11/3x15,5 **	5
	158	m1x11/1x32 **	5
	158	m1x13/3x17 **	5
	158	m1x30 **	5
	158	m1x35 **	5
	158	m2x4,5/2x21 **	5
	158	m2x11/2x17 **	5
	158	m2x15 **	5
	158	m2x16 **	5
	158	m3x12,5 **	5
	158	m3x13,5 **	5
	158	m3x14,5 **	5
	158	m3x18 **	5
	158	m4x12 **	5
	158	m4x16 **	5
	158	m6x5,1/1x10/1x10,5/2x13 **	5
	158	m8x10 **	5
	158	m8x12 **	5
	158	m13x3,5/9x5,2 **	5
	158	m18x7 **	5
	158	m23x3,3/4x5,1 **	5

* Dichteinsatz kurz = Art.-Nr.: Ek... ** Variante PC nicht lieferbar. Variante y aus Werkstoff POM (Farbe weiß), Temperaturbereich: -40 °C bis +110 °C. Es besteht keine CSA-Zulassung.
* Sealing insert short = art. no.: Ek... ** Variant PC not available. Variant y made of POM (white colour), temperature range: -40 °C up to +110 °C, no CSA approval

i Ausführung Polycarbonat/PVDF: Schutzart IP 68 ausschließlich in Verbindung mit separat erhältlicher Flachdichtung auf Seite 468
Version polycarbonate/PVDF: type of protection IP 68 only in combination with separately available flat seal ring on page 468

UNI Dicht Pg geschlossen

UNI Dicht Pg closed



Abb. 1
Fig. 1

Abb. 2
Fig. 2

**Messing vernickelt, Edelstahl 1.4305, Polycarbonat, PVDF
Pg-Anschlussgewinde
Mit O-Ring HNBR/Silikon
Schutzart IP 68 bis 10 bar**

Brass, nickel-plated, stainless steel AISI 303, polycarbonate, PVDF
Pg connection thread
With o-ring HNBR/silicone
Type of protection IP 68 up to 10 bar

i Anschlussgewinde mit 15 mm Länge auf Anfrage
Long connection thread 15 mm on request

Werkstoff Verschraubungskörper Material gland body	Ausführung/Farbe Version/colour	Bestellschlüssel Art. no. supplement	Werkstoff Dichteinsatz Material sealing insert	Farbe Colour	Bestellschlüssel Art. no. supplement	Temperaturbereich min./max. Temperature range (min./max.)
Messing Brass	Vernickelt Nickel-plated	d	TPE	Weiß White		-40 °C / +130 °C
Messing Brass	Vernickelt Nickel-plated	d	TPE-V	Natur Natural	p	-40 °C / +135 °C
VA 1.4305 AISI 303	Blank	st	TPE	Weiß White		-40 °C / +130 °C
VA 1.4305 AISI 303	Blank	st	TPE-V	Natur Natural	p	-40 °C / +135 °C
PC	Grau Grey	PC	TPE	Weiß White		-20 °C / +100 °C
PC	Grau Grey	PC	TPE-V	Natur Natural	p	-20 °C / +100 °C
PVDF	Transparent	y	TPE	Weiß White		-40 °C / +130 °C
PVDF	Transparent	y	TPE-V	Natur Natural	p	-40 °C / +135 °C



Abb. 3
Fig. 3

Anschlussgewinde Connection thread	Art.-Nr. Art. no.		
		Ausführung bitte ergänzen Please complete product details	
		Messing/Brass = d	
		VA 1.4305/AISI 303 = st	
A		PC = PC	= TPE
		PVDF = y	p = TPE-V
Pg 7	149	g	50
Pg 9	150	g	50
Pg 11	151	g	50
Pg 13,5	152	g	50
Pg 16	153	g	50
Pg 21	154	g	25
	154	g/21 *	25
Pg 29	155	g	10
Pg 36	156	g	5
Pg 42	157	g **	5
Pg 48	158	g **	5

* Variante in y und PC nicht erhältlich ** Variante y und PC aus Werkstoff POM (Farbe weiß); Temperaturbereich: -40 °C bis +110 °C.
* Variant in y and PC not available ** Variant y and PC made of POM (white colour), temperature range: -40 °C up to +110 °C

i Die Anleitung zur Herstellung einer Kabelverschraubung mit eigenem Lochbild aus einem geschlossenen Dichteinsatz finden Sie im Technischen Anhang.
The instructions for making a cable gland with its own hole pattern from a closed sealing insert can be found in the technical appendix.

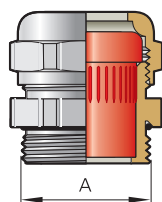
i Maximaler Kabeldurchlass der Druckschraube (F) und maximaler Kabeldurchlass des Doppelnippels (E) siehe Technischer Anhang
For maximum cable passage of the pressure screw (F) and maximum cable passage of the double nipple (E), see technical appendix.

i Hinweise zu den Baumaßen finden Sie auf Seite 483.
For information for the system dimensions, see page 483.

i Farbvarianten für
Colour variants for

PC:	PCn = schwarz
PVDF:	ya = blau
	yn = schwarz
PC:	PCn = black
PVDF:	ya = blue
	yn = black

i Ausführung Polycarbonat/PVDF: Schutzart IP 68 ausschließlich in Verbindung mit separat erhältlicher Flachdichtung auf Seite 468
Version polycarbonate/PVDF: type of protection IP 68 only in combination with separately available flat seal ring on page 468

UNI Stecker Pg-Kabelverschraubung mit geteiltem Dichteinsatz

UNI Connector Pg cable gland with split sealing insert

CE RoHS



Abb. 1
Fig. 1

Abb. 2
Fig. 2

Messing vernickelt, Edelstahl 1.4305, Polycarbonat, PVDF
Pg-Anschlussgewinde
Schutzart IP 68 bis 10 bar

Brass, nickel-plated, stainless steel AISI 303, polycarbonate, PVDF
Pg connection thread
Type of protection IP 68 up to 10 bar

i Farbvarianten für
Colour variants for

PC:	PCn = schwarz
PVDF:	ya = blau
	yn = schwarz
PC:	PCn = black
PVDF:	ya = blue
	yn = black

Werkstoff Verschraubungskörper Material gland body	Ausführung/Farbe Version/colour	Bestellschlüssel Art. no. supplement	Werkstoff Dichteinsatz Material sealing insert	Farbe Colour	Temperaturbereich min./max. Temperature range (min./max.)
Messing Brass	Vernickelt Nickel-plated		TPE-V	Natur Natural	-40 °C / +135 °C
VA 1.4305 AISI 303	Blank	st	TPE-V	Natur Natural	-40 °C / +135 °C
PC	Grau Grey	PC	TPE-V	Natur Natural	-20 °C / +100 °C
PVDF	Transparent	y	TPE-V	Natur Natural	-40 °C / +135 °C

Anschlussgewinde Connection thread	Art.-Nr. Art. no.		
		Ausführung bitte ergänzen Please complete product details	
	Messing/Brass	=	
	VA 1.4305/AISI 303	=	st
A	PC	=	PC
	PVDF	=	y
Pg 29	155	pmK	10
	155	pmK 1/ 5	10
	155	pmK 1/ 6	10
	155	pmK 1/ 6-1/ 8,5	10
	155	pmK 1/ 7	10
	155	pmK 1/ 8	10
	155	pmK 1/10	10
	155	pmK 1/12	10
	155	pmK 1/13,5	10
	155	pmK 1/17	10
	155	pmK 1/21	10
	155	pmK 2/ 6	10
	155	pmK 2/ 8	10
	155	pmK 2/10	10
Pg 36	156	pmK	5
	156	pmK 1/ 4,5	5
	156	pmK 1/ 4,5-1/ 9-1/ 9,5	5
	156	pmK 1/ 5-1/10-1/10,5	5
	156	pmK 1/ 8	5
	156	pmK 1/ 8-1/10,5-1/12	5
	156	pmK 1/10	5
	156	pmK 1/11	5
	156	pmK 1/12	5
	156	pmK 1/21	5
	156	pmK 1/23	5
	156	pmK 2/ 5,5-1/11,5	5

21800 | TTD1920

UNI Stecker Pg-Kabelverschraubung mit geteiltem Dichteinsatz

UNI Connector Pg cable gland with split sealing insert

Fortsetzung von vorheriger Seite
Continued from previous page

Anschlussgewinde Connection thread		Art.-Nr. Art. no.	
Ausführung bitte ergänzen Please complete product details			
		Messing/Brass	=
		VA 1.4305/AISI 303	= st
		PC	= PC
		PVDF	= y
Pg 36	156	pmK 2/ 6	5
	156	pmK 2/11,5	5
	156	pmK 3/ 7,2	5
	156	pmK 3/ 7,5	5
	156	pmk 3/ 7,8	5
	156	pmK 3/10	5
Pg 42	157	pmK *	5
	157	pmK 1/9 *	5
	157	pmK 1/26 *	5
	157	pmK 1/27 *	5
	157	pmK 1/30 *	5

Anschlussgewinde Connection thread		Art.-Nr. Art. no.	
Ausführung bitte ergänzen Please complete product details			
		Messing/Brass	=
		VA 1.4305/AISI 303	= st
		PC	= PC
		PVDF	= y
Pg 42	157	pmK 1/32 *	5
	157	pmK 2/ 9 *	5
Pg 48	158	pmK *	5
	158	pmK 1/ 6 *	5
	158	pmK 1/ 6-1/ 8 *	5
	158	pmK 1/ 8 *	5
	158	pmK 1/28 *	5
	158	pmK 1/29 *	5
	158	pmK 1/32 *	5
	158	pmK 2/ 8 *	5

* Variante y und PC aus Werkstoff POM (Farbe weiß); Temperaturbereich: -40 °C bis +110 °C.

* Variant y and PC made of POM (white colour), temperature range: -40 °C up to +110 °C

i

Das Problem:

Häufig liegen Geräte bereits installiert mit konfektionierten Bauteilen an der Anschlussleitung vor. In der Praxis lassen sich diese Leitungen nur mit geteilten Flanschplatten installieren.

Die Lösung:

Im PFLITSCH-System UNI Stecker sind Dichteinsätze in der Verschraubungsachse geteilt.

- voll, zum Selberbohren mit geeignetem Bohrer
- mit einer Bohrung
- mit mehreren Bohrungen
- Technische Details siehe Seite 477

The problem:

Equipment is frequently installed with assembled components on the connection line. Practically speaking, these lines can only be installed with divided flange plates.

The solution:

In the PFLITSCH UNI Connector system, the sealing inserts are divided on the gland axis.

- Full, for self-drilling with drill
- With one borehole
- With several boreholes
- Technical details see page 477

UNI Dicht ASI-Bus Pg-Kabelverschraubung

UNI Dicht ASI-Bus Pg cable gland

CE RoHS



Abb. 1
Fig. 1



Abb. 2
Fig. 2

Messing vernickelt
Pg-Anschlussgewinde
Mit O-Ring HNBR
Schutzart IP 68 bis 10 bar

Brass, nickel-plated
Pg connection thread
With o-ring HNBR
Type of protection IP 68 up to 10 bar

i Ausführung in Polycarbonat auf Anfrage
Polycarbonate version on request

Werkstoff Verschraubungskörper Material gland body	Ausführung/Farbe Version/colour	Werkstoff Dichteinsatz Material sealing insert	Farbe Colour	Temperaturbereich min./max. Temperature range (min./max.)
Messing Brass	Vernickelt Nickel-plated	TPE-V	Natur Natural	-40 °C / +135 °C



Abb. 3
Fig. 3

Anschlussgewinde/-länge Connection thread/length		Art.-Nr. Art. no.	Version ASI Version ASI	Bauhöhe Mounting height	Schlüsselweite Spanner width	
A	D mm			C mm	SW x E mm	
Pg 13,5	6,5	152pm2xASI L	2x links/2x left	21,0	22x24,4	50
		152pm2xASI R	2x rechts/2x right	21,0	22x24,4	50
		152pf4,2ASI10L	links/left	21,0	22x24,4	50
		152pfm2xASIL/R	links & rechts/left & right	21,0	22x24,4	50
		152pf4,2ASI10R	rechts/right	21,0	22x24,4	50

22900 | IT02500

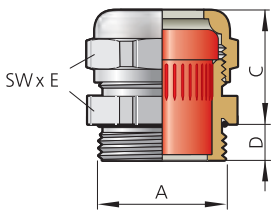

Abb. 4 – ASI-Kabelquerschnitt links = lange Bezugs-kante
Fig. 4 – ASI cable cross section left = long reference edge

UNI Dicht ASI-Bus Pg-Kabelverschraubung

UNI Dicht ASI-Bus Pg cable gland

CE RoHS



Abb. 1
Fig. 1

Edelstahl 1.4305
Pg-Anschlussgewinde
Mit O-Ring Silikon
Schutzart IP 68 bis 10 bar

Stainless steel AISI 303
Pg connection thread
With o-ring silicone
Type of protection IP 68 up to 10 bar

Werkstoff Verschraubungskörper Material gland body	Ausführung/Farbe Version/colour	Werkstoff Dichteinsatz Material sealing insert	Farbe Colour	Temperaturbereich min./max. Temperature range (min./max.)
VA 1.4305 AISI 303	Blank	TPE-V	Natur Natural	-40 °C / +135 °C



Abb. 2
Fig. 2

Anschlussgewinde/-länge Connection thread/length		Art.-Nr. Art. no.	Version ASI Version ASI	Bauhöhe Mounting height	Schlüsselweite Spanner width	
A	D mm			C mm	SW x E mm	
Pg 13,5	6,5	152stpm2xASI L	2x links/2x left	21,0	22x24,4	50
		152stpm2xASI R	2x rechts/2x right	21,0	22x24,4	50
		152stpf4,2ASI10L	links/left	21,0	22x24,4	50
		152stpfm2xASIL/R	links & rechts/left & right	21,0	22x24,4	50
		152stpf4,2ASI10R	rechts/right	21,0	22x24,4	50

23000 | IT03500

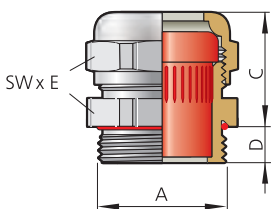

Abb. 3 – ASI-Kabelquerschnitt 2-fach links = lange Bezugs-kante
Fig. 3 – ASI cable cross section dual left = long reference edge

UNI Dicht ASI-Bus Pg-Kabelverschraubung

RoHS

UNI Dicht ASI-Bus Pg cable gland



PVDF, Farbe: transparent, blau (RAL 5015), schwarz (RAL 9005)
Pg-Anschlussgewinde
Schutzart IP 68 bis 10 bar

PVDF, colour: transparent, blue (RAL 5015), black (RAL 9005)
Pg connection thread
Type of protection IP 68 up to 10 bar

Abb. 1
Fig. 1

i Schutzart IP 68 ausschließlich in Verbindung mit separat erhältlicher Flachdichtung auf Seite 468
 Type of protection IP 68 only in combination with separately available flat sealing ring on page 468

Werkstoff Verschraubungskörper Material gland body	Ausführung/Farbe Version/colour	Bestellschlüssel Art. no. supplement	Werkstoff Dichteinsatz Material sealing insert	Farbe Colour	Temperaturbereich min./max. Temperature range (min./max.)
PVDF	Transparent		TPE-V	Natur Natural	-40 °C / +135 °C
PVDF	Blau Blue	a	TPE-V	Natur Natural	-40 °C / +135 °C
PVDF	Schwarz Black	n	TPE-V	Natur Natural	-40 °C / +135 °C



Abb. 2
Fig. 2



Abb. 3 – ASI-Kabelquerschnitt links & rechts = lange Bezugskante
 Fig. 3 – ASI cable cross section left & right = long reference edge

Anschlussgewinde/-länge Connection thread/length		Art.-Nr. Art. no.	Version ASI Version ASI	Bauhöhe Mounting height	Schlüsselweite Spanner width
Ausführung bitte ergänzen Please complete product details					
A	D mm	Transparent = Blau/Blue = a Schwarz/Black = n		C mm	SW x E mm
Pg 13,5	9,0	152y	pm2xASI L 2x links/2x left	22,0	24x26,5 50
		152y	pm2xASI R 2x rechts/2x right	22,0	24x26,5 50
		152y	pf4,2ASI10L links/left	22,0	24x26,5 50
		152y	pfm2xASIL/R links & rechts/left & right	22,0	24x26,5 50
		152y	pf4,2ASI10R rechts/right	22,0	24x26,5 50

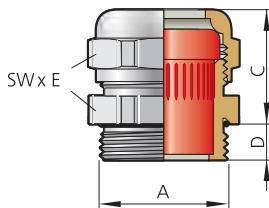
23200 | IT02600

UNI Flach Pg-Kabelverschraubung – Gerundet

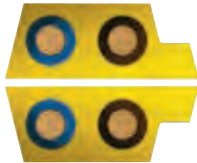
UNI Flat Pg cable gland – Rounded



Abb. 1
Fig. 1



Abb. 2
Fig. 2

**Messing vernickelt, Edelstahl 1.4305, Polycarbonat, PVDF
Pg-Anschlussgewinde
Schutzart IP 65 – Form gerundet**

Brass, nickel-plated, stainless steel AISI 303, polycarbonate, PVDF
Pg connection thread
Type of protection IP 65 – rounded shape

i **Farbvarianten für** **PC:** **PCn = schwarz**
Colour variants for **PVDF:** **ya = blau**
PC: **yn = schwarz**
PVDF: **PCn = black**
ya = blue
yn = black

Werkstoff Verschraubungskörper Material gland body	Ausführung/Farbe Version/colour	Bestellschlüssel Art. no. supplement	Werkstoff Dichteinsatz Material sealing insert	Farbe Colour	Bestellschlüssel Art. no. supplement	Temperaturbereich min./max. Temperature range (min./max.)
Messing Brass	Vernickelt Nickel-plated		TPE	Weiß White		-40 °C / +130 °C
Messing Brass	Vernickelt Nickel-plated		TPE-V	Natur Natural	p	-40 °C / +135 °C
VA 1.4305 AISI 303	Blank	st	TPE	Weiß White		-40 °C / +130 °C
VA 1.4305 AISI 303	Blank	st	TPE-V	Natur Natural	p	-40 °C / +135 °C
PC	Grau Grey	PC	TPE	Weiß White		-20 °C / +100 °C
PC	Grau Grey	PC	TPE-V	Weiß White	p	-20 °C / +100 °C
PVDF	Transparent	y	TPE	Weiß White		-40 °C / +130 °C
PVDF	Transparent	y	TPE-V	Natur Natural	p	-40 °C / +135 °C





Abb. 3
Fig. 3

Anschlussgewinde Connection thread	Art.-Nr. Art. no.	Ausführung bitte ergänzen Please complete product details	
A	Messing/Brass	=	
	VA 1.4305/AISI 303	= st	
	PC	= PC	= TPE
	PVDF	= y	p = TPE-V
Pg 9	150	f 3,5g 5,5	50
Pg 11	151	f 2,8g 10,5	50
	151	f 3,5g 6	50
	151	f 3,5g 9	50
	151	f 4 g 6	50
Pg 13,5	152	f 3 g 12	50
	152	f 3g 12	50
	152	f 4,5g 10	50
	152	f 5 g 11	50
	152	f 5 g 12	50
Pg 16	153	f 6,5g 11	50
	153	f 5 g 12	50
	153	f 5 g 10	50
	153	f 5 g 16	50
	153	f 5,5g 14	50
Pg 21	153	f 6 g 13	50
	153	f 7,5g 14	50
	154	f 5 g 17	25
Pg 29	154	f 7 g 18	25
	155	f 10 g 25	10
	155	f 10 g 29	10
	155	f 13 g 28	10
	155	f 6 g 29	10
	155	f 8 g 25	10

23500 | T101900

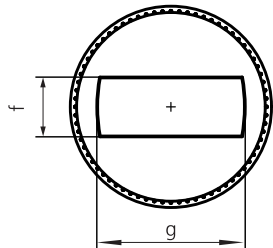
Fortsetzung auf der nächsten Seite
Continued on next page

UNI Flach Pg-Kabelverschraubung – Gerundet
UNI Flat Pg cable gland – Rounded
 Fortsetzung von vorheriger Seite
Continued from previous page

Anschlussgewinde <i>Connection thread</i>	Art.-Nr. <i>Art. no.</i>	Ausführung bitte ergänzen <i>Please complete product details</i>		
A	Messing/Brass	=		
	VA 1.4305/AISI 303	=	st	
	PC	=	PC	= TPE
	PVDF	=	y	p = TPE-V
Pg 36	156		f11 g34	5
	156		f12 g35	5
	156		f 6 g30	5
	156		f 6 g36	5
	156		f 8 g36	5
Pg 42	157		f10 g38 *	5
	157		f13 g35 *	5

Anschlussgewinde <i>Connection thread</i>	Art.-Nr. <i>Art. no.</i>	Ausführung bitte ergänzen <i>Please complete product details</i>		
A	Messing/Brass	=		
	VA 1.4305/AISI 303	=	st	
	PC	=	PC	= TPE
	PVDF	=	y	p = TPE-V
Pg 42	157		f14,5g37 *	5
	157		f 6 g38 *	5
Pg 48	158		f14,5g39 *	5
	158		f15 g45 *	5
	158		f 6,5g47 *	5
	158		f 9 g43 *	5

* Variante PC nicht lieferbar. Variante y aus Werkstoff POM (Farbe weiß), Temperaturbereich: -40 °C bis +110 °C

* Variant PC not available. Variant y made of POM (white colour), temperature range: -40 °C up to +110 °C

233560 | TT01900

UNI Flach Pg-Kabelverschraubung – Oval

UNI Flat Pg cable gland – Oval



Abb. 1
Fig. 1



Abb. 2
Fig. 2

**Messing vernickelt, Edelstahl 1.4305, Polycarbonat, PVDF
Pg-Anschlussgewinde
Schutzart IP 65 – Form oval**

*Brass. nickel-plated, stainless steel AISI 303, polycarbonate, PVDF
Pg connection thread
Type of protection IP 65 – oval shape*

i	Farbvarianten für	PC:	PCn = schwarz
	<i>Colour variants for</i>	PVDF:	ya = blau yn = schwarz
		<i>PC:</i>	<i>PCn = black</i>
		<i>PVDF:</i>	<i>ya = blue yn = black</i>

Werkstoff Verschraubungskörper <i>Material gland body</i>	Ausführung/Farbe <i>Version/colour</i>	Bestellschlüssel <i>Art. no. supplement</i>	Werkstoff Dichteinsatz <i>Material sealing insert</i>	Farbe <i>Colour</i>	Bestellschlüssel <i>Art. no. supplement</i>	Temperaturbereich min./max. <i>Temperature range (min./max.)</i>
Messing Brass	Vernickelt Nickel-plated		TPE	Weiß White		-40 °C / +130 °C
Messing Brass	Vernickelt Nickel-plated		TPE-V	Natur Natural	p	-40 °C / +135 °C
VA 1.4305 AISI 303	Blank	st	TPE	Weiß White		-40 °C / +130 °C
VA 1.4305 AISI 303	Blank	st	TPE-V	Natur Natural	p	-40 °C / +135 °C
PC	Grau Grey	PC	TPE	Weiß White		-20 °C / +100 °C
PC	Grau Grey	PC	TPE-V	Weiß White	p	-20 °C / +100 °C
PVDF	Transparent	y	TPE	Weiß White		-40 °C / +130 °C
PVDF	Transparent	y	TPE-V	Natur Natural	p	-40 °C / +135 °C





Abb. 3
Fig. 3

Anschlussgewinde <i>Connection thread</i>	Art.-Nr. <i>Art. no.</i>	Ausführung bitte ergänzen <i>Please complete product details</i>	
A	Messing/Brass	=	
	VA 1.4305/AISI 303	= st	
	PC	= PC	= TPE
	PVDF	= y	p = TPE-V
Pg 7	149	f 1,2v 4	50
	149	f 2 v 4	50
Pg 11	151	f 4,5v 7	50
Pg 13,5	152	f 2,5v10	50
	152	f 5 v 8	50
	152	f 5 v12	50
	152	f 6 v 9,1	50
	152	f 8 v10,5	50
Pg 16	153	f 5 v 7	50
	153	f 5 v10	50
	153	f 5 v12	50
	153	f 5 v15	50
	153	f 5,5v 8,5	50
	153	f 6 v12,5	50
	153	f 6 v14	50
	153	f 6 v15	50
	153	f 6,5v16,5	50
	153	f 7 v14	50
Pg 21	154	f 5 v16	25
	154	f 7 v16,5	25
	154	f 7 v18	25
	154	f 7 v20	25

23600 | IT101900

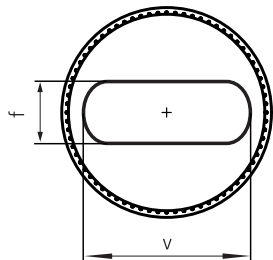
Fortsetzung auf der nächsten Seite
Continued on next page

UNI Flach Pg-Kabelverschraubung – Oval
UNI Flat Pg cable gland – Oval
 Fortsetzung von vorheriger Seite
Continued from previous page

Anschlussgewinde <i>Connection thread</i>	Art.-Nr. <i>Art. no.</i>	Ausführung bitte ergänzen <i>Please complete product details</i>		
A	Messing/Brass	=		
	VA 1.4305/AISI 303	= st		
	PC	= PC	= TPE	
	PVDF	= y	p = TPE-V	
Pg 29	155	f 4 v23	10	
	155	f 8 v25	10	
	155	f10 v27	10	
Pg 36	156	f11 v35	5	
	156	f13 v30,5	5	

* Variante y aus Werkstoff POM (Farbe weiß); Temperaturbereich: -40 °C bis +110 °C

* Variant y made of POM (white colour), temperature range: -40 °C up to +110 °C

Anschlussgewinde <i>Connection thread</i>	Art.-Nr. <i>Art. no.</i>	Ausführung bitte ergänzen <i>Please complete product details</i>		
A	Messing/Brass	=		
	VA 1.4305/AISI 303	= st		
	PC	= PC	= TPE	
	PVDF	= y	p = TPE-V	
Pg 36	156	f 5,5v31	5	
	156	f 6,5v32	5	
Pg 42	157	f 6 v41 *	5	
	157	f 9 v38 *	5	
Pg 48	158	f 9 v43 *	5	

23600 | T101900

UNI Flach Pg-Kabelverschraubung – Eckig

UNI Flat Pg cable gland – Angular



**Messing vernickelt, Edelstahl 1.4305, Polycarbonat, PVDF
Pg-Anschlussgewinde
Schutzart IP 43 – Form eckig**

Brass, nickel-plated, stainless steel AISI 303, polycarbonate, PVDF
Pg connection thread
Type of protection IP 43 – angular shape

Abb. 1
Fig. 1

i Farbvarianten für Colour variants for	PC:	PCn = schwarz
	PVDF:	yn = blau
	PC:	PCn = black
	PVDF:	yn = blue
		yn = black

Werkstoff Verschraubungskörper Material gland body	Ausführung/Farbe Version/colour	Bestellschlüssel Art. no. supplement	Werkstoff Dichteinsatz Material sealing insert	Farbe Colour	Bestellschlüssel Art. no. supplement	Temperaturbereich min./max. Temperature range (min./max.)
Messing Brass	Vernickelt Nickel-plated		TPE	Weiß White		-40 °C / +130 °C
Messing Brass	Vernickelt Nickel-plated		TPE-V	Natur Natural	p	-40 °C / +135 °C
VA 1.4305 AISI 303	Blank	st	TPE	Weiß White		-40 °C / +130 °C
VA 1.4305 AISI 303	Blank	st	TPE-V	Natur Natural	p	-40 °C / +135 °C
PC	Grau Grey	PC	TPE	Weiß White		-20 °C / +100 °C
PC	Grau Grey	PC	TPE-V	Weiß White	p	-20 °C / +100 °C
PVDF	Transparent	y	TPE	Weiß White		-40 °C / +130 °C
PVDF	Transparent	y	TPE-V	Natur Natural	p	-40 °C / +135 °C



Abb. 2
Fig. 2

Anschlussgewinde Connection thread	Art.-Nr. Art. no.	Ausführung bitte ergänzen Please complete product details	
A	Messing/Brass	=	
	VA 1.4305/AISI 303	= st	
	PC	= PC	= TPE
	PVDF	= y	p = TPE-V
Pg 16	153	f 8 e12	50
Pg 21	154	f 4 e15	25
Pg 29	155	f 6 e26	10
	155	f 7 e26	10
Pg 36	156	f 8 e30	5
Pg 42	157	f 5,5e37 *	5
	157	f 6 e39 *	5

* Variante y aus Werkstoff POM (Farbe weiß); Temperaturbereich: -40 °C bis +110 °C
 * Variant y made of POM (white colour), temperature range: -40 °C up to +110 °C

23610 | TT01900

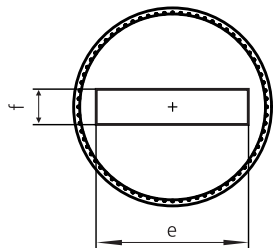
Zugentlastung und Biegeschutz – Pg

*Strain relief
and bending protection – Pg*



Abb. 1 – UNI Biegeschutz Dicht-Kabelverschraubung
Fig. 1 – UNI Dicht Bending protection cable gland

Abb. 2 – UNI Zug Dicht-Kabelverschraubung
Fig. 2 – UNI Dicht Strain relief cable gland

Abb. 3 – UNI Flex Dicht
Fig. 3 – UNI Flex Dicht

Erhöhte Zugentlastung inklusive

PFLITSCH-Kabelverschraubungen verfügen bereits serienmäßig über Zugentlastungswerte, die der Norm EN 62444, Klasse A, entsprechen. Noch mehr Sicherheit durch erhöhte Zugentlastung bringen die Baureihen UNI Zug, UNI Klemm und UNI Biege Zug aus dem UNI Dicht-Baukasten. Ebenso sind hier Lösungen für einen umfassenden Biegeschutz zu finden.

UNI Zug mit integrierten Spannbacken

Bei der UNI Zug bestehen die Dichteinsätze aus TPE und TPE-V mit integrierten Klemmkörpern aus PA, die wie ein Spannfutter wirken und Zugkräfte bis über 200 N am Kabel vibrationsfest abfangen.

UNI Klemm mit Bügelschellen

Mit zwei Bügelschellen an der Druckschraube lassen sich bei der UNI Klemm Kabel sicher fixieren. Dabei werden Zugkräfte bis über 500 N abgefangen. UNI Klemm entspricht damit der in der Norm EN 62444 geforderten „Ausführung B“.

UNI Biegeschutz Dicht-Kabelverschraubungen

Diese Kabelverschraubungen verhindern durch eine lange, konische Biegeschutztülle aus TPE, dass die Kabel an der Biegestelle beschädigt werden. Die Tülle liegt fest am Kabel an und hält äußere Einflüsse, wie z. B. UV-Strahlung und aggressive Medien, von dem unter Biegestress stehenden Kabelabschnitt fern. Zur einfacheren Montage kann die Tülle aufgeweitet werden, um das Kabel leichter durchschieben zu können.

UNI Biege Zug – die perfekte Kombination

Eine interessante Variante ist die UNI Biege Zug-Kabelverschraubung. Ihr Dichteinsatz ist mit Spannbacken für eine vibrationsfeste Zugentlastung ausgestattet und verfügt über eine angespritzte große Tülle, die das Kabel sicher vor dem Abknicken schützt, beispielsweise bei Industrie-Steckverbindern.

UNI Flex für noch mehr Biegeschutz

Mit einer speziell gewendelten Edelstahlfeder mit progressiver Kennlinie optimiert die UNI Flex die Verteilung der Biegebeanspruchungen des Kabels. Auf etwa 10 cm Länge fängt diese Kabelverschraubung selbst hohe dynamische Biegebelastungen am Kabeleintritt sicher ab.

Increased strain relief included

PFLITSCH cable glands are produced as standard with strain relief values that correspond to the EN 62444 class A standard. The models UNI Strain relief, UNI Clamping and UNI Bending Strain relief from the UNI Dicht modular range provide even more safety with increased strain relief.

UNI Strain relief with integrated clamping jaws

With UNI Strain relief, the sealing inserts made of TPE and TPE-V are fitted with integrated clamping bodies made of PA which act like clamping jaws. Tractive forces on the cable are intercepted up to 200 N with vibration resistance.

UNI Clamping with clips

With two clips on the pressure screw, cables can be securely fixated using UNI Clamping. Tractive forces of up to over 500 N can be absorbed here. UNI Clamping is thus consistent with "Execution B" in the EN 62444 standard.

UNI Dicht Bending protection cable glands

These cable glands prevent – through a long, conical bending protection socket made of TPE – cables from being damaged at the bending point. The socket fits rigidly to the cable and keeps external influences, such as a UV radiation and aggressive media, away from the section of cable which is under bending strain. The socket can be widened for simpler mounting for the cable to be pushed through more easily.

UNI Bending Strain relief – the perfect combination

An interesting variant is the UNI Bending Strain relief cable gland. Its sealing insert is fitted with clamping jaws and is equipped with an extruded large nozzle, reliably protecting the cable against kinking, for example, in industrial plug connectors.

UNI Flex for even more bending protection

UNI Flex optimises distribution of the cable's bending loads with a specially coiled stainless steel spring with progressive characteristic. This cable gland will safely absorb even high dynamic bending loads at the cable entry over a length of approx. 10 cm.

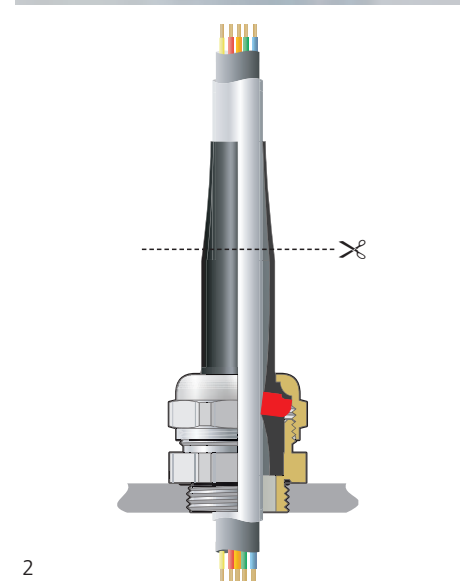

- ✂ Durch Kürzen des Konus wird die Tülle auf den jeweiligen Kabelquerschnitt angepasst.
- ✂ Shortening the cone enables the socket to be adapted to the particular cable cross section concerned.

Abb. 1 – UNI Klemm Dicht-Kabelverschraubung
Fig. 1 – UNI Clamping Dicht cable gland

Abb. 2 – Schema UNI Biege Zug
Fig. 2 – Section of the UNI Bending Strain relief

UNI Zug Dicht Pg-Kabelverschraubung

UNI Dicht Strain relief Pg cable gland



Abb. 1
Fig. 1



Abb. 2
Fig. 2

**Messing vernickelt
Pg-Anschlussgewinde
Mit O-Ring HNBR
Schutzart IP 54**

Brass, nickel-plated
Pg connection thread
With o-ring HNBR
Type of protection IP 54

i Auf Anfrage erhältlich: Anschlussgewinde 15 mm und Ausführung in Edelstahl
Available on request: connection thread 15 mm and stainless steel version

Werkstoff Verschraubungskörper Material gland body	Ausführung/Farbe Version/colour	Werkstoff Dichteinsatz Material sealing insert	Farbe Colour	Bestellschlüssel Art. no. supplement	Temperaturbereich min./max. Temperature range (min./max.)
Messing Brass	Vernickelt Nickel-plated	TPE	s. FC s. CC		-20 °C / +100 °C
Messing Brass	Vernickelt Nickel-plated	TPE-V	Natur Natural	p	-20 °C / +100 °C



Abb. 3
Fig. 3

Anschlussgewinde/-länge Connection threadlength		Art.-Nr. Art. no.	Dichtbereich Sealing range	Bauhöhe Mounting height	Schlüsselweite Spanner width		
A	D mm	TPE = TPE-V = p	max./min. ø mm	C mm	SW x E mm		
		Ausführung bitte ergänzen Please complete product details					
Pg 7	5,0	149 14950	z 7 z 9	6,5 – 4,0 9,0 – 5,5	20,0 20,0	14x15,5 17x18,9	50 50
Pg 9	6,0	150 15051 15052	z 7 z 9 z11 z13 *	6,5 – 4,0 9,0 – 5,5 10,0 – 6,0 12,0 – 8,0	20,0 20,0 21,0 21,0	17x18,9 17x18,9 20x22,2 22x24,4	50 50 50 50
Pg 11	6,0	151 151 15152	z 9 z11 z13	9,0 – 5,5 10,0 – 6,0 12,0 – 8,0	20,0 20,0 21,0	20x22,2 20x22,2 22x24,4	50 50 50
Pg 13,5	6,5	152 152 152 15253 15254 15254	z 9 z11 z13 z16 z18 z20	9,0 – 5,5 10,0 – 6,0 12,0 – 8,0 15,0 – 12,0 17,0 – 14,0 20,0 – 16,0	21,0 21,0 21,0 21,0 25,0 25,0	22x24,4 22x24,4 22x24,4 24x26,7 30x33,5 30x33,5	50 50 50 50 25 25
Pg 16	6,5	153 153 153 15354 15354 15355 15355	z11 z13 z16 z18 z20 z25 z28	10,0 – 6,0 12,0 – 8,0 15,0 – 12,0 17,0 – 14,0 20,0 – 16,0 24,0 – 20,0 27,0 – 23,0	21,0 21,0 21,0 24,0 24,0 27,0 27,0	24x26,7 24x26,7 24x26,7 30x33,5 30x33,5 40x43,5 40x43,5	50 50 50 25 25 25 25
Pg 21	7,0	154 154 154 154 15455 15455	z13 z16 z18 z20 z25 z28	12,0 – 8,0 15,0 – 12,0 17,0 – 14,0 20,0 – 16,0 24,0 – 20,0 27,0 – 23,0	25,0 25,0 25,0 25,0 27,0 27,0	30x33,5 30x33,5 30x33,5 30x33,5 40x43,5 40x43,5	25 25 25 25 10 10
Pg 29	8,0	155 155 155 15556 15556	z21 z25 z28 z32 z36	20,0 – 16,0 24,0 – 20,0 27,0 – 23,0 31,5 – 27,0 36,0 – 32,0	28,0 28,0 28,0 28,0 28,0	40x43,5 40x43,5 40x43,5 50x54 50x54	10 10 10 10 10
Pg 36	9,0	156 156 15657	z32 z36 z40	31,5 – 27,0 36,0 – 32,0 40,0 – 34,0	28,0 28,0 30,0	50x54 50x54 57x61	10 10 5
Pg 42	10,0	157	z40	40,0 – 34,0	30,0	57x61	5
Pg 48	10,0	158	z44	43,0 – 39,0	30,0	64x69	5

* Dichteinsatz kurz = Art.-Nr.: Ek...
* Sealing insert short = art. no.: Ek...

i Passende Gegenmuttern ab Seite 442
Corresponding locknuts see from page 442

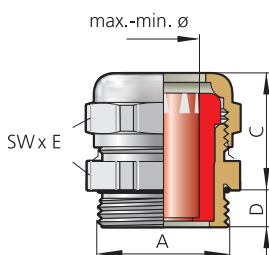
UNI Zug Dicht Pg-Kabelverschraubung

UNI Dicht Strain relief Pg cable gland

RoHS



Abb. 1
Fig. 1

Abb. 2
Fig. 2

**Polycarbonat, Farbe: grau (RAL 7035), schwarz (RAL 9005)
Pg-Anschlussgewinde
Schutzart IP 54**

Polycarbonate, colour: grey (RAL 7035), black (RAL9005)
Pg connection thread
Type of protection IP 54

i **Passende Gegenmuttern ab Seite 442**
Corresponding locknuts see from page 442

Werkstoff Verschraubungskörper Material gland body	Ausführung/Farbe Version/colour	Bestellschlüssel Art. no. supplement	Werkstoff Dichteinsatz Material sealing insert	Farbe Colour	Bestellschlüssel Art. no. supplement	Temperaturbereich min./max. Temperature range (min./max.)
PC	Grau Grey		TPE	s. FC s. CC		-20 °C / +100 °C
PC	Grau Grey		TPE-V	Natur Natural	p	-20 °C / +100 °C
PC	Schwarz Black	n	TPE	s. FC s. CC		-20 °C / +100 °C
PC	Schwarz Black	n	TPE-V	Natur Natural	p	-20 °C / +100 °C



Abb. 3
Fig. 3

Anschlussgewinde/-länge Connection thread/length		Art.-Nr. Art. no.	Dichtbereich Sealing range	Bauhöhe Mounting height	Schlüsselweite Spanner width	
		Ausführung bitte ergänzen Please complete product details				
A	D mm	Grau/Grey = Schwarz/Black = n	= TPE = TPE-V	max./min. ø mm	C mm	SW x E mm
Pg 7	8,0	149PC 14950PC	z 7 z 9 *	6,5 – 4,0 9,0 – 5,5	23,0 22,0	15x16,5 19x21,2
Pg 9	9,0	150PC 150PC	z 7 z 9	6,5 – 4,0 9,0 – 5,5	23,0 23,0	19x21,2 19x21,2
Pg 9	8,0	15051PC	z11 *	10,0 – 6,0	24,0	22x24,4
Pg 11	9,0	151PC 151PC	z 9 z11	9,0 – 6,0 10,0 – 6,0	24,0 24,0	22x24,4 22x24,4
Pg 11	8,0	15152PC	z13 *	13,0 – 9,0	24,0	24x26,5
Pg 13,5	9,0	152PC 152PC 152PC	z 9 z11 z13	9,0 – 5,5 10,0 – 6,0 12,0 – 8,0	24,0 24,0 24,0	24x26,5 24x26,5 24x26,5
Pg 13,5	8,5	15253PC	z16 *	15,0 – 12,0	24,0	27x29,5
Pg 16	9,0	153PC 153PC 153PC 15354PC 15354PC	z11 z13 z16 z18 * z20 *	10,0 – 6,0 12,0 – 8,0 15,0 – 12,0 17,0 – 14,0 20,0 – 16,0	24,0 24,0 24,0 30,0 30,0	27x29,5 27x29,5 27x29,5 33x36,5 33x36,5
Pg 21	11,0	154PC 154PC 154PC 154PC 15455PC 15455PC	z13 z16 z18 z20 z25 * z28 *	12,0 – 8,0 15,0 – 12,0 17,0 – 14,0 20,0 – 16,0 24,0 – 20,0 27,0 – 23,0	29,0 29,0 29,0 29,0 34,0 34,0	33x36,5 33x36,5 33x36,5 33x36,5 43x46,5 43x46,5
Pg 29	11,0	155PC 155PC 155PC 15556PC 15556PC	z21 z25 z28 z32 * z36 *	20,0 – 16,0 24,0 – 20,0 27,0 – 23,0 31,5 – 27,0 32,0 – 36,0	33,0 33,0 33,0 35,0 35,0	43x46,5 43x46,5 43x46,5 53x57 53x57
Pg 36	14,0	156PC 156PC	z32 z36	31,5 – 27,0 36,0 – 32,0	33,0 33,0	53x57 53x57

* Dichteinsatz kurz = Art.-Nr.: Ek...
* Sealing insert short = art. no.: Ek...

UNI Zug Dicht Pg-Kabelverschraubung

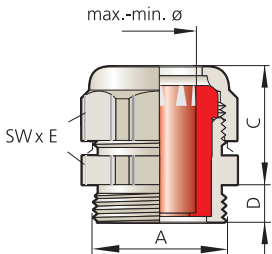
UNI Dicht Strain relief Pg cable gland



Abb. 1
Fig. 1



Abb. 2
Fig. 2

**PVDF, Farbe: transparent, blau (RAL 5015), schwarz (RAL 9005)
Pg-Anschlussgewinde
Schutzart IP 54**

*PVDF, colour: transparent, blue (RAL 5015), black (RAL 9005)
Pg connection thread
Type of protection IP 54*

Werkstoff Verschraubungskörper Material gland body	Ausführung/Farbe Version/colour	Bestellschlüssel Art. no. supplement	Werkstoff Dichteinsatz Material sealing insert	Farbe Colour	Bestellschlüssel Art. no. supplement	Temperaturbereich min./max. Temperature range (min./max.)
PVDF	Transparent		TPE	s. FC s. CC		-20 °C / +100 °C
PVDF	Transparent		TPE-V	Natur Natural	p	-20 °C / +100 °C
PVDF	Blau Blue	a	TPE	s. FC s. CC		-20 °C / +100 °C
PVDF	Blau Blue	a	TPE-V	Natur Natural	p	-20 °C / +100 °C
PVDF	Schwarz Black	n	TPE	s. FC s. CC		-20 °C / +100 °C
PVDF	Schwarz Black	n	TPE-V	Natur Natural	p	-20 °C / +100 °C



Abb. 3
Fig. 3

Anschlussgewinde/-länge Connection thread/length		Art.-Nr. Art. no.	Dichtbereich Sealing range	Bauhöhe Mounting height	Schlüsselweite Spanner width
Ausführung bitte ergänzen Please complete product details					
		Transparent = a Blau/Blue = n Schwarz/Black = p	= TPE = TPE-V		
A	D mm		max./min. ø mm	C mm	SW x E mm
Pg 7	8,0	149y z 7	6,5 – 4,0	23,0	15x16,5 50
Pg 9	8,0	150y z 7	6,5 – 4,0	24,0	19x21,2 50
		150y z 9	9,0 – 5,5	24,0	19x21,2 50
		15051y z11 *	10,0 – 6,0	24,0	22x24,4 50
Pg 11	8,0	151y z 9	9,0 – 6,0	24,0	22x24,4 50
		151y z11	10,0 – 6,0	24,0	22x24,4 50
Pg 13,5	9,0	152y z 9	9,0 – 5,5	26,0	24x26,5 50
		152y z11	10,0 – 6,0	26,0	24x26,5 50
		152y z13	12,0 – 8,0	26,0	24x26,5 50
		15254y z20 *	20,0 – 16,0	30,0	33x36,5 25
Pg 16	9,0	153y z11	10,0 – 6,0	26,0	27x29,5 50
		153y z13	12,0 – 8,0	26,0	27x29,5 50
		153y z16	15,0 – 12,0	26,0	27x29,5 50
		15354y z18 *	17,0 – 14,0	30,0	33x36,5 25
		15354y z20 *	20,0 – 16,0	30,0	33x36,5 25
Pg 16	10,0	15355y z28 *	27,0 – 23,0	32,0	43x46 10
Pg 21	11,0	154y z13	12,0 – 8,0	29,0	33x36,5 25
		154y z16	15,0 – 12,0	29,0	33x36,5 25
		154y z18	17,0 – 14,0	29,0	33x36,5 25
		154y z20	20,0 – 16,0	29,0	33x36,5 25
		15455y z25 *	24,0 – 20,0	33,0	43x46 10
		15455y z28 *	27,0 – 23,0	33,0	43x46 10
Pg 21	10,0	15456y z36 *	36,0 – 32,0	35,0	53x57 5
Pg 29	10,5	155y z20	20,0 – 16,0	33,0	43x46,5 10
		155y z25	24,0 – 20,0	33,0	43x46,5 10
		155y z28	27,0 – 23,0	33,0	43x46,5 10
Pg 29	11,0	15556y z36 *	36,0 – 32,0	35,0	53x57 5
Pg 36	13,0	156y z32	31,5 – 27,0	34,0	53x57 5
		156y z36	36,0 – 32,0	34,0	53x57 5
Pg 42	13,0	157y z40 **	40,0 – 36,0	38,0	60x65 5
Pg 48	14,0	158y z44 **	43,0 – 39,0	41,0	65x70 5

* Dichteinsatz kurz = Art.-Nr.: Ek... ** Werkstoff POM (Farbe weiß), Temperaturbereich: -40 °C bis +110 °C.
* Sealing insert short = art. no.: Ek... ** Material POM (white colour), temperature range: -40 °C up to +110 °C

UNI Klemm Dicht Pg-Kabelverschraubung

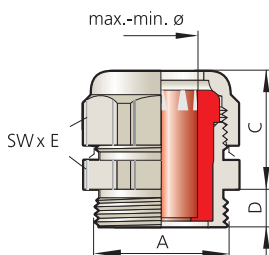
UNI Clamping Dicht Pg cable gland



Abb. 1
Fig. 1



Abb. 2
Fig. 2

Messing vernickelt
Druckschraube mit erhöhter Zugentlastung
Pg-Anschlussgewinde
Mit O-Ring HNBR
Schutzart IP 68 – statisch geprüft

Brass, nickel-plated
Pressure screw with increased strain relief
Pg connection thread
With o-ring HNBR
Type of protection IP 68 – statically tested

i **Passende Gegenmuttern ab Seite 442**
Corresponding locknuts see from page 442

Werkstoff Verschraubungskörper Material gland body	Ausführung/Farbe Version/colour	Werkstoff Dichteinsatz Material sealing insert	Farbe Colour	Bestellschlüssel Art. no. supplement	Temperaturbereich min./max. Temperature range (min./max.)
Messing Brass	Vernickelt Nickel-plated	TPE	s. FC s. CC	d	-40 °C / +130 °C
Messing Brass	Vernickelt Nickel-plated	TPE-V	Natur Natural	p	-40 °C / +135 °C
Messing Brass	Vernickelt Nickel-plated	Silikon HT Silicone HT	Schwarz Black	H	-55 °C / +200 °C





Abb. 3
Fig. 3

Anschlussgewinde/-länge Connection thread/length		Art.-Nr. Art. no.	Dichtbereich Sealing range	Bauhöhe Mounting height	Schlüsselweite Spanner width		
Ausführung bitte ergänzen Please complete product details							
A	D mm	TPE = d	max./min. ø mm	C mm	SW x E mm		
		TPE-V = p					
		Silikon HT/Silicone HT = H					
Pg 7	5,0	14950	8zu *	8,0 – 6,0	39,0	17x18,9	50
		14950	9zu *	9,5 – 6,5	39,0	17x18,9	50
Pg 9	6,0	150	8zu	8,0 – 6,0	39,0	17x18,9	50
		150	9zu	9,5 – 6,5	39,0	17x18,9	50
		15051	11zu *	10,5 – 7,0	39,0	20x22,2	50
		15052	13zu *	13,0 – 9,0	39,0	22x24,4	50
Pg 11	6,0	151	7zu	6,5 – 4,0	39,0	20x22,2	50
		151	8zu	8,0 – 5,0	39,0	20x22,2	50
		151	9zu	9,5 – 6,5	39,0	20x22,2	50
		151	11zu	10,5 – 7,0	39,0	20x22,2	50
		15152	13zu *	13,0 – 9,0	39,0	22x24,4	50
Pg 13,5	6,5	152	9zu	9,5 – 7,0	39,0	22x24,4	50
		152	11zu	10,5 – 7,0	39,0	22x24,4	50
		152	13zu	13,0 – 9,0	39,0	22x24,4	50
		15253	16zu *	15,5 – 11,5	40,0	24x26,7	50
Pg 16	6,5	153	9zu	9,5 – 7,0	41,0	24x26,7	50
		153	11zu	10,5 – 7,0	41,0	24x26,7	50
		153	13zu	13,0 – 9,0	41,0	24x26,7	50
		153	16zu	15,5 – 11,5	41,0	24x26,7	50
		15354	18zu *	18,0 – 14,0	48,0	30x33,5	25
15354	20zu *	20,5 – 17,0	48,0	30x33,5	25		
Pg 21	7,0	154	13zu	13,0 – 10,0	48,0	30x33,5	25
		154	16zu	15,5 – 11,5	48,0	30x33,5	25
		154	18zu	18,0 – 14,0	48,0	30x33,5	25
		154	20zu	20,5 – 17,0	48,0	30x33,5	25
		15455	25zu *	25,0 – 20,0	51,0	40x43,5	10
Pg 29	8,0	155	18zu	18,0 – 14,0	51,0	40x43,5	10
		155	20zu	20,5 – 17,0	51,0	40x43,5	10
		155	25zu	25,0 – 20,0	51,0	40x43,5	10
		155	28zu	28,0 – 24,0	51,0	40x43,5	10
		15556	32zu *	32,0 – 27,0	52,0	50x54	5

* Dichteinsatz kurz = Art.-Nr.: Ek...
* Sealing insert short = art. no.: Ek...

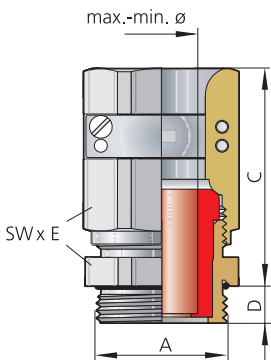
UNI Klemm Dicht Pg-Kabelverschraubung
UNI Clamping Dicht Pg cable gland
 Fortsetzung von vorheriger Seite
Continued from previous page

Anschlussgewinde/-länge <i>Connection thread/length</i>		Art.-Nr. <i>Art. no.</i>		Dichtbereich <i>Sealing range</i>	Bauhöhe <i>Mounting height</i>	Schlüsselweite <i>Spanner width</i>		
A	D mm	TPE = d	H	max./min. ø mm	C mm	SW x E mm		
		TPE-V = p						
		Silikon HT/Silicone HT = H		Ausführung bitte ergänzen <i>Please complete product details</i>				
Pg 36	9,0	156	H	32zu	32,0–27,0	52,0	50x54	5
				34zu	34,0–29,0	52,0	50x54	5
				36zu	36,0–32,0	52,0	50x54	5
Pg 48	10,0	158	H	44zu	44,0–39,0	54,0	64x69	5
G2 1/2"	15,0	1212	H	47zu *	47,0–42,0	61,0	81x87	1
				52zu *	52,0–45,0	61,0	81x87	2
				55zu *	55,0–51,0	61,0	81x87	2
				58zu *	58,0–54,0	61,0	81x87	2
G3"	15,0	1300	H	57zu *	57,0–52,0	62,0	95x102	1
				64zu *	64,0–58,0	62,0	95x102	1
				70zu *	70,0–63,0	62,0	95x102	1

* Dichteinsatz aus Silikon HT nicht lieferbar
 * *Sealing insert silicone HT not available*

151.00 | IT00410

UNI Biegeschutz Dicht Pg-Kabelverschraubung

UNI Dicht Bending protection cable gland



Messing vernickelt
Pg-Anschlussgewinde
Mit O-Ring HNBR
Schutzart IP 68 bis 10 bar

Brass, nickel-plated
 Pg connection thread
 With o-ring HNBR
 Type of protection IP 68 up to 10 bar

Abb. 1
Fig. 1

Abb. 2
Fig. 2

i **Passende Gegenmuttern ab Seite 442**
 Corresponding locknuts see from page 442

Werkstoff Verschraubungskörper Material gland body	Ausführung/Farbe Version/colour	Werkstoff Dichteinsatz Material sealing insert	Farbe Colour	Temperaturbereich min./max. Temperature range (min./max.)
Messing Brass	Vernickelt (v) Nickel-plated (n)	TPE-V	Schwarz Black	-40 °C / +135 °C



Abb. 3
Fig. 3

Anschlussgewinde/-länge Connection thread/length A	D mm	Art.-Nr. Art. no.	Dichtbereich Sealing range max./min. ø mm	Bauhöhe Mounting height C mm	Schlüsselweite Spanner width SW x E mm	
Pg 7	5,0	149dLp 4/V2	4,0– 2,5	53,0	14x15,5	50
		149dLp 5/V2	5,0– 3,5	53,0	14x15,5	50
		149dLp 6/V2	6,0– 4,5	53,0	14x15,5	50
		149dLp 6,5/V2	6,5– 5,5	53,0	14x15,5	50
Pg 9	6,0	150dLp 5,5/V2	5,5– 4,0	64,0	17x18,9	50
		150dLp 6/V2	6,0– 5,0	64,0	17x18,9	50
		150dLp 7,5/V2	7,5– 5,5	64,0	17x18,9	50
Pg 11	6,0	151dLp 5,5/V2	5,5– 4,0	66,0	20x22,2	50
		151dLp 6,5/V2	6,5– 5,0	66,0	20x22,2	50
		151dLp 8/V2	8,0– 6,0	66,0	20x22,2	50
		151dLp 9,5/V2	9,5– 7,5	66,0	20x22,2	50
Pg 13,5	6,5	152dLp 6,5/V2	6,5– 5,0	77,0	22x24,4	50
		152dLp 7,5/V2	7,5– 6,0	77,0	22x24,4	50
		152dLp 8,5/V2	8,5– 7,0	77,0	22x24,4	50
		152dLp10,5/V2	10,5– 8,0	77,0	22x24,4	50
Pg 16	6,5	153dLp 8/V2	8,0– 6,5	83,0	24x26,7	25
		153dLp 9,5/V2	9,5– 7,5	83,0	24x26,7	25
		153dLp11/V2	11,0– 9,0	83,0	24x26,7	25
		153dLp13/V2	13,0– 10,5	83,0	24x26,7	25
Pg 21	7,0	154dLp10/V2	10,0– 8,0	80,0	30x33,5	10
		154dLp11,5/V2	11,5– 9,5	80,0	30x33,5	10
		154dLp13,5/V2	13,5– 11,0	80,0	30x33,5	10
		154dLp15,5/V2	15,5– 13,0	80,0	30x33,5	10
		154dLp17,5/V2	17,5– 15,0	80,0	30x33,5	10
Pg 29	8,0	155dLp19,5/V2	19,5– 16,0	84,0	40x43,5	10
		155dLp22/V2	22,0– 19,0	84,0	40x43,5	10
		155dLp24/V2	24,0– 21,0	84,0	40x43,5	10

147100 | IT00720

UNI Biegeschutz Dicht Pg-Kabelverschraubung

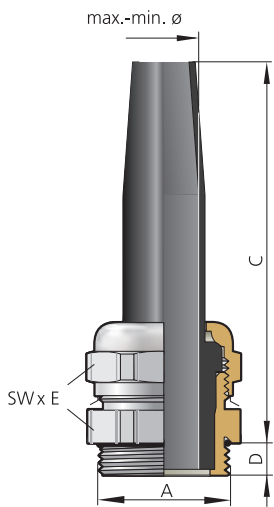
UNI Dicht Bending protection Pg cable gland



Abb. 1
Fig. 1

Abb. 2
Fig. 2

**Polycarbonat, Farbe: grau (RAL 7035), schwarz (RAL 9005)
Pg-Anschlussgewinde
Schutzart IP 68 bis 10 bar**

Polycarbonate, colour: grey (RAL 7035), black (RAL 9005)
Pg connection thread
Type of protection IP 68 up to 10 bar

i **Passende Gegenmuttern ab Seite 442**
Corresponding locknuts see from page 442

Werkstoff Verschraubungskörper Material gland body	Ausführung/Farbe Version/colour	Bestellschlüssel Art. no. supplement	Werkstoff Dichteinsatz Material sealing insert	Farbe Colour	Temperaturbereich min./max. Temperature range (min./max.)
PC	Grau Grey		TPE-V	Schwarz Black	-20 °C / +100 °C
PC	Schwarz Black	n	TPE-V	Schwarz Black	-20 °C / +100 °C



Abb. 3
Fig. 3

Anschlussgewinde/-länge Connection thread/length		Art.-Nr. Art. no.	Dichtbereich Sealing range	Bauhöhe Mounting height	Schlüsselweite Spanner width	
		Ausführung bitte ergänzen Please complete product details				
A	D mm	Grau/Grey = Schwarz/Black = n	max./min. ø mm	C mm	SW x E mm	
Pg 7	8,0	149PC	Lp 4/V2 4,0 – 2,5	58,0	15x16,5	50
		149PC	Lp 5/V2 5,0 – 3,5			
		149PC	Lp 6/V2 6,0 – 4,5			
		149PC	Lp 6,5/V2 6,5 – 5,5			
Pg 9	9,0	150PC	Lp 5,5/V2 5,5 – 4,0	65,0	19x21,2	50
		150PC	Lp 6/V2 6,0 – 5,0			
		150PC	Lp 7,5/V2 7,5 – 5,5			
Pg 11	9,0	151PC	Lp 5,5/V2 5,5 – 4,0	67,0	22x24,4	50
		151PC	Lp 6,5/V2 6,5 – 5,0			
		151PC	Lp 8/V2 8,0 – 6,0			
		151PC	Lp 9,5/V2 9,5 – 7,5			
Pg 13,5	9,0	152PC	Lp 6,5/V2 6,5 – 5,0	80,0	24x26,5	50
		152PC	Lp 7,5/V2 7,5 – 6,0			
		152PC	Lp 8,5/V2 8,5 – 7,0			
		152PC	Lp10,5/V2 10,5 – 8,0			
Pg 16	9,0	153PC	Lp 8/V2 8,0 – 6,5	81,0	27x29,5	25
		153PC	Lp 9,5/V2 9,5 – 7,5			
		153PC	Lp11/V2 11,0 – 9,0			
		153PC	Lp13/V2 13,0 – 10,5			
Pg 21	11,0	154PC	Lp10/V2 10,0 – 8,0	82,0	33x36,5	10
		154PC	Lp11,5/V2 11,5 – 9,5			
		154PC	Lp13,5/V2 13,5 – 11,0			
		154PC	Lp15,5/V2 15,5 – 13,0			
		154PC	Lp17,5/V2 17,5 – 15,0			
Pg 29	11,0	155PC	Lp19,5/V2 19,5 – 16,0	88,0	43x46,5	10
		155PC	Lp22/V2 22,0 – 19,0			
		155PC	Lp24/V2 24,0 – 21,0			

i **Schutzart IP 68 ausschließlich in Verbindung mit separat erhältlicher Flachdichtung auf Seite 468**
Type of protection IP 68 only in combination with separately available flat sealing ring on page 468

U73. UNI Biegeschutz Dicht Pg-Kabelverschraubung

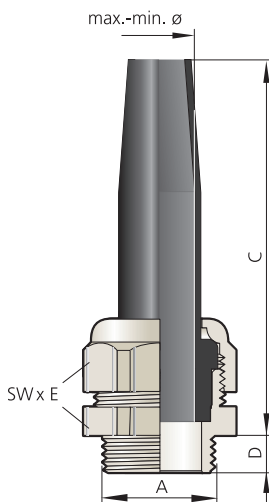
U73. UNI Dicht Bending protection Pg cable gland



Abb. 1
Fig. 1

Abb. 2
Fig. 2

**PVDF, Farbe: transparent, schwarz (RAL 9005)
Pg-Anschlussgewinde
Schutzart IP 68 bis 10 bar**

*PVDF, colour: transparent, black (RAL 9005)
Pg connection thread
Type of protection IP 68 up to 10 bar*

i Schutzart IP 68 ausschließlich in Verbindung mit separat erhältlicher Flachdichtung auf Seite 468
Type of protection IP 68 only in combination with separately available flat sealing ring on page 468

Werkstoff Verschraubungskörper Material gland body	Ausführung/Farbe Version/colour	Bestellschlüssel Art. no. supplement	Werkstoff Dichteinsatz Material sealing insert	Farbe Colour	Temperaturbereich min./max. Temperature range (min./max.)
PVDF	Transparent		TPE-V	Schwarz Black	-40 °C / +135 °C
PVDF	Blau Blue	a	TPE-V	Schwarz Black	-40 °C / +135 °C
PVDF	Schwarz Black	n	TPE-V	Schwarz Black	-40 °C / +135 °C



Abb. 3
Fig. 3

Anschlussgewinde/-länge Connection thread/length		Art.-Nr. Art. no.	Dichtbereich Sealing range	Bauhöhe Mounting height	Schlüsselweite Spanner width	
		Ausführung bitte ergänzen Please complete product details				
		Transparent = a				
		Blau/Blue = n				
		Schwarz/Black = n				
A	D mm		max./min. ø mm	C mm	SW x E mm	
Pg 7	8,0	149y Lp 4/V2	4,0– 2,5	58,0	15x16,5 50	
		149y Lp 5/V2	5,0– 3,5	58,0	15x16,5 50	
		149y Lp 6/V2	6,0– 4,5	58,0	15x16,5 50	
		149y Lp 6,5/V2	6,5– 5,5	58,0	15x16,5 50	
Pg 9	8,0	150y Lp 5,5/V2	5,5– 4,0	65,0	19x21,2 50	
		150y Lp 6/V2	6,0– 5,0	65,0	19x21,2 50	
		150y Lp 7,5/V2	7,5– 5,5	65,0	19x21,2 50	
Pg 11	8,0	151y Lp 5,5/V2	5,5– 4,0	67,0	22x24,4 50	
		151y Lp 6,5/V2	6,5– 5,0	67,0	22x24,4 50	
		151y Lp 8/V2	8,0– 6,0	67,0	22x24,4 50	
		151y Lp 9,5/V2	9,5– 7,5	67,0	22x24,4 50	
Pg 13,5	9,0	152y Lp 6,5/V2	6,5– 5,0	80,0	24x26,5 50	
		152y Lp 7,5/V2	7,5– 6,0	80,0	24x26,5 50	
		152y Lp 8,5/V2	8,5– 7,0	80,0	24x26,5 50	
		152y Lp10,5/V2	10,5– 8,0	80,0	24x26,5 50	
Pg 16	9,0	153y Lp 8/V2	8,0– 6,0	81,0	27x29,5 25	
		153y Lp 9,5/V2	9,5– 7,5	81,0	27x29,5 25	
		153y Lp11/V2	11,0– 9,0	81,0	27x29,5 25	
		153y Lp13/V2	13,0– 10,5	81,0	27x29,5 25	
Pg 21	11,0	154y Lp10/V2	10,0– 8,0	82,0	33x36,5 10	
		154y Lp11,5/V2	11,5– 9,5	82,0	33x36,5 10	
		154y Lp13,5/V2	13,5– 11,0	82,0	33x36,5 10	
		154y Lp15,5/V2	15,5– 13,0	82,0	33x36,5 10	
		154y Lp17,5/V2	17,5– 15,0	82,0	33x36,5 10	
Pg 29	10,5	155y Lp19,5/V2	19,5– 16,0	88,0	43x46,5 10	
		155y Lp22/V2	22,0– 19,0	88,0	43x46,5 10	
		155y Lp24/V2	24,0– 21,0	88,0	43x46,5 10	

149901 | T00710

UNI Flex Dicht Pg-Kabelverschraubung

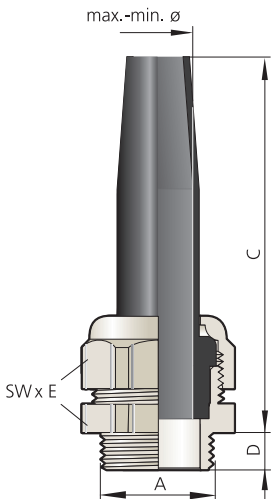
UNI Flex Dicht Pg cable gland



Abb. 1
Fig. 1



Abb. 2
Fig. 2

Messing vernickelt, Feder aus Edelstahl
Pg-Anschlussgewinde
Mit O-Ring HNBR/Silikon
Schutzart IP 68 – statisch geprüft
Zugentlastung bis Klasse A, EN 62444

Brass, nickel-plated, spring made of stainless steel
Pg connection thread
With o-ring HNBR/silicone
Type of protection IP 68 – statically tested
Strain relief up to class A, EN 62444

i **Flexible Leitungen an Robotern, Handbediengeräten, Fußschaltern etc. sind am Gerät besonderen Beanspruchungen unterworfen. Die UNI Flex gibt den Leitungen einen definierten Biegeradius und schützt vor Aderbruch.**
Flexible lines on robots, hand controllers, foot switches, etc. are subjected to special loads at the cross-over to the equipment. The UNI Flex provides the lines with a defined bending radius and protection against conductor breaks.

Werkstoff Verschraubungskörper Material gland body	Ausführung/Farbe Version/colour	Werkstoff Dichteinsatz Material sealing insert	Farbe Colour	Bestellschlüssel Art. no. supplement	Temperaturbereich min./max. Temperature range (min./max.)
Messing Brass	Vernickelt Nickel-plated	TPE	s. FC s. CC		-40 °C / +130 °C
Messing Brass	Vernickelt Nickel-plated	TPE-V	Natur Natural	p	-40 °C / +135 °C
Messing Brass	Vernickelt Nickel-plated	Silikon HT Silicone HT	Schwarz Black	H	-55 °C / +200 °C



Abb. 3
Fig. 3

Anschlussgewinde/-länge Connection thread/length		Art.-Nr. Art. no.	Dichtbereich Sealing range	Bauhöhe Mounting height	Schlüsselweite Spanner width	
		Ausführung bitte ergänzen Please complete product details				
A	D mm	TPE = TPE-V = p Silikon HT/Silicone HT = H	max./min. ø mm	C mm	SW x E mm	
Pg 9	6,0	15052dF	14.07V2	6,5 – 4,0	80,0	22x24,4 25
		15052dF	14.09V2	9,5 – 6,5	80,0	22x24,4 25
		15052dF	14.11V2	10,5 – 7,0	80,0	22x24,4 25
Pg 11	6,0	15152dF	14.07V2	6,5 – 4,0	80,0	22x24,4 25
		15152dF	14.09V2	9,5 – 6,5	80,0	22x24,4 25
		15152dF	14.11V2	10,5 – 7,0	80,0	22x24,4 25
		15152dF	14.13V2	13,0 – 9,0	80,0	22x24,4 25
Pg 13,5	6,5	15253dF	16.16V2	15,5 – 11,5	81,0	24x26,7 25
		152dF	14.07V2	6,5 – 4,0	81,0	22x24,4 25
		152dF	14.09V2	9,5 – 6,5	81,0	22x24,4 25
		152dF	14.11V2	10,5 – 7,0	81,0	22x24,4 25
		152dF	14.13V2	13,0 – 9,0	81,0	22x24,4 25
Pg 16	6,5	15354dF	19.18V2	18,0 – 14,0	85,0	30x33,5 10
		153dF	16.11V2	10,5 – 7,0	82,0	24x26,7 25
		153dF	16.13V2	13,0 – 9,0	82,0	24x26,7 25
		153dF	16.16V2	15,5 – 11,5	82,0	24x26,7 25
Pg 21	7,0	154dF	19.18V2	18,0 – 14,0	90,0	30x33,5 10

15000 | TT00410

UNI Biege Zug Pg-Kabelverschraubung

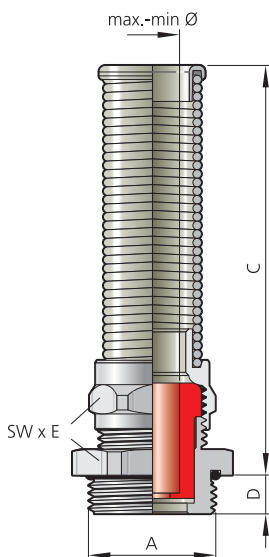
UNI Bending Strain relief Pg cable gland



Abb. 1
Fig. 1



Abb. 2
Fig. 2

Messing vernickelt
Pg-Anschlussgewinde
Mit O-Ring HNBR
Schutzart IP 54
Integrierte Zugentlastung – vibrationsfest

Brass, nickel-plated
Pg connection thread
With o-ring HNBR
Type of protection IP 54
Integrated strain relief – vibration-resistant

Werkstoff Verschraubungskörper Material gland body	Ausführung/Farbe Version/colour	Werkstoff Dichteinsatz Material sealing insert	Farbe Colour	Temperaturbereich min./max. Temperature range (min./max.)
Messing Brass	Vernickelt Nickel-plated	TPE-V	Schwarz Black	-40 °C / +135 °C



Abb. 3
Fig. 3

Anschlussgewinde/-länge Connection thread/length A	D mm	Art.-Nr. Art. no.	Dichtbereich Sealing range max./min. ø mm	Bauhöhe Mounting height C mm	Schlüsselweite Spanner width SW x E mm	
Pg 7	5,0	14950Lzp 7*	6,5– 4,5	54,0	17x18,9	50
Pg 9	6,0	150Lzp 7	6,5– 4,5	54,0	17x18,9	50
		15051Lzp 9*	9,0– 6,0	63,0	20x22,2	50
		15052Lzp 9*	9,5– 6,5	68,0	22x24,4	50
		15052Lzp 11*	10,5– 8,5	68,0	22x24,4	50
Pg 11	6,0	151Lzp 9	9,0– 6,0	63,0	20x22,2	50
		15152Lzp 11*	10,5– 8,5	69,0	22x24,4	50
Pg 13,5	6,5	152Lzp 9	9,5– 6,5	69,0	22x24,4	50
		152Lzp 11	10,5– 8,5	69,0	22x24,4	50
		15253Lzp 13*	13,0– 9,0	73,0	24x26,7	25
		15254Lzp 16*	15,5– 13,0	78,0	30x33,5	10
Pg 16	6,5	153Lzp 9	9,5– 6,5	73,0	24x26,7	25
		153Lzp 11	10,5– 8,5	73,0	24x26,7	25
		153Lzp 13	13,0– 9,0	73,0	24x26,7	25
		15354Lzp 16*	15,5– 13,0	78,0	30x33,5	25
Pg 21	7,0	154Lzp 13	13,0– 9,0	78,0	30x33,5	10
		154Lzp 16	15,5– 13,0	78,0	30x33,5	10
		154Lzp 18	17,5– 14,0	78,0	30x33,5	10
		15455Lzp 21*	20,0– 17,0	103,0	40x43,5	10
Pg 29	8,0	155Lzp 21	20,5– 17,0	104,0	40x43,5	10
		155Lzp 25	24,0– 21,0	104,0	40x43,5	10

* Dichteinsatz kurz = Art.-Nr.: Ek...
* Sealing insert short = art. no.: Ek...

i **Passende Gegenmuttern ab Seite 442**
Corresponding locknuts see from page 442

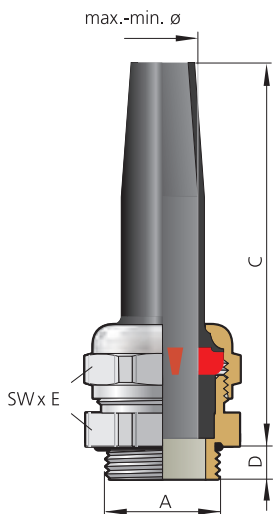
15300 | IT000720

UNI Biege Zug Pg-Kabelverschraubung

UNI Bending Strain relief Pg cable gland

RoHS



Abb. 1
Fig. 1



Abb. 2
Fig. 2

Polycarbonat, Farbe: grau (RAL 7035), schwarz (RAL 9005)
Pg-Anschlussgewinde
Schutzart IP 54
Integrierte Zugentlastung – vibrationsfest

Polycarbonate, colour: grey (RAL 7035), black (RAL9005)
 Pg connection thread
 Type of protection IP 54
 Integrated strain relief – vibration-resistant

Werkstoff Verschraubungskörper Material gland body	Ausführung/Farbe Version/colour	Bestellschlüssel Art. no. supplement	Werkstoff Dichteinsatz Material sealing insert	Farbe Colour	Temperaturbereich min./max. Temperature range (min./max.)
PC	Grau Grey		TPE-V	Schwarz Black	-20 °C / +100 °C
PC	Schwarz Black	n	TPE-V	Schwarz Black	-20 °C / +100 °C



Abb. 3
Fig. 3

Anschlussgewinde/-länge Connection thread/length		Art.-Nr. Art. no.	Dichtbereich Sealing range	Bauhöhe Mounting height	Schlüsselweite Spanner width
		Ausführung bitte ergänzen Please complete product details			
A	D mm	Grau/Grey = Schwarz/Black = n	max./min. ø mm	C mm	SW x E mm
Pg 9	8,0	15051PC	Lzp 9 *	9,0 – 6,0	64,0 22x24,5 50
Pg 11	9,0	151PC	Lzp 9	9,0 – 6,0	64,0 22x24,5 50
Pg 11	8,0	15152PC	Lzp11 *	10,5 – 8,5	72,0 24x26,5 50
Pg 13,5	9,0	152PC	Lzp13	9,5 – 6,5	72,0 24x26,5 50
		152PC	Lzp 11	10,5 – 8,5	72,0 24x26,5 50
Pg 13,5	8,5	15253PC	Lzp13 *	13,0 – 9,0	75,0 27x29,5 25
Pg 16	9,0	153PC	Lzp 9	9,5 – 6,5	76,0 27x29,5 25
		153PC	Lzp 11	10,5 – 8,5	76,0 27x29,5 25
		153PC	Lzp13	13,0 – 9,0	76,0 27x29,5 25
		15354PC	Lzp16 *	15,5 – 13,0	80,0 33x36,5 10
Pg 21	11,0	154PC	Lzp13	13,0 – 9,0	80,0 33x36,5 10
		154PC	Lzp16	15,5 – 13,0	80,0 33x36,5 10
		154PC	Lzp18	17,5 – 14,0	80,0 33x36,5 10
		15455PC	Lzp21 *	20,5 – 17,0	104,0 43x46,5 10
Pg 29	11,0	155PC	Lzp21	20,0 – 17,0	108,0 43x46,5 5
		155PC	Lzp25	24,0 – 21,0	108,0 43x46,5 5

* Dichteinsatz kurz = Art.-Nr.: Ek...
 * Sealing insert short = art. no.: Ek...

i **Passende Gegenmuttern ab Seite 442**
 Corresponding locknuts see from page 442

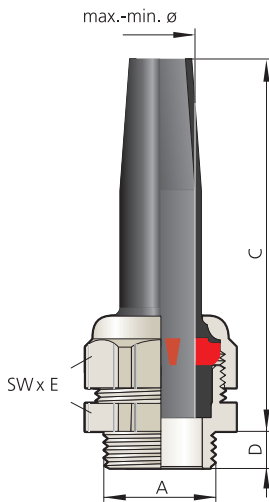
15400 | TT00710

UNI Biege Zug Pg-Kabelverschraubung

UNI Bending Strain relief Pg cable gland

CE RoHS



Abb. 1
Fig. 1



Abb. 2
Fig. 2

PVDF, Farbe: transparent, blau (RAL 5015), schwarz (RAL 9005)
Pg-Anschlussgewinde
Schutzart IP 54
Integrierte Zugentlastung – vibrationsfest

PVDF, colour: transparent, blue (RAL 5015), black (RAL 9005)
Pg connection thread
Type of protection IP 54
Integrated strain relief – vibration-resistant

Werkstoff Verschraubungskörper Material gland body	Ausführung/Farbe Version/colour	Bestellschlüssel Art. no. supplement	Werkstoff Dichteinsatz Material sealing insert	Farbe Colour	Temperaturbereich min./max. Temperature range (min./max.)
PVDF	Transparent		TPE-V	Schwarz Black	-20 °C / +100 °C
PVDF	Blau Blue	a	TPE-V	Schwarz Black	-20 °C / +100 °C
PVDF	Schwarz Black	n	TPE-V	Schwarz Black	-20 °C / +100 °C



Abb. 3
Fig. 3

Anschlussgewinde/-länge Connection thread/length		Art.-Nr. Art. no.	Dichtbereich Sealing range	Bauhöhe Mounting height	Schlüsselweite Spanner width		
A	D mm		max./min. ø mm	C mm	SW x E mm		
		Ausführung bitte ergänzen Please complete product details					
		Transparent =					
		Blau/Blue = a					
		Schwarz/Black = n					
Pg 7	8,0	14950y	Lzp 7 *	6,5– 4,5	55,0	19x21,2 50	
Pg 9	8,0	150y	Lzp 7	6,5– 4,5	55,0	19x21,2 50	
		15051y	Lzp 9 *	9,0– 6,0	64,0	22x24,5 50	
Pg 9	8,5	15052y	Lzp11 *	10,5– 8,5	72,0	24x26,5 50	
Pg 11	8,0	151y	Lzp 9	9,5– 6,5	64,0	22x24,5 50	
		15152y	Lzp11 *	10,5– 8,5	72,0	24x26,5 50	
Pg 11	9,0	15153y	Lzp13 *	13,0– 9,0	76,0	27x29,5 25	
Pg 13,5	9,0	152y	Lzp 9	9,5– 6,5	72,0	24x26,5 50	
		152y	Lzp11	10,5– 8,5	72,0	24x26,5 50	
Pg 13,5	8,5	15253y	Lzp13 *	13,0– 9,0	76,0	27x29,5 25	
Pg 13,5	9,0	15254y	Lzp16 *	15,5– 13,0	76,0	33x36,5 10	
Pg 16	9,0	153y	Lzp 9	9,5– 6,5	80,0	27x29,5 25	
		153y	Lzp11	10,5– 8,5	80,0	27x29,5 25	
		153y	Lzp13	13,0– 9,0	80,0	27x29,5 25	
		15354y	Lzp16 *	15,5– 13,0	80,0	33x36,5 10	
Pg 21	11,0	154y	Lzp13	13,0– 9,0	80,0	33x36,5 10	
		154y	Lzp16	15,5– 13,0	80,0	33x36,5 10	
		154y	Lzp18	17,5– 14,0	80,0	33x36,5 10	
		15455y	Lzp21 *	20,0– 17,0	104,0	43x46,5 10	
Pg 29	10,5	155y	Lzp21	20,0– 17,0	108,0	43x46,5 10	
		155y	Lzp25	24,0– 21,0	108,0	43x46,5 10	

* Dichteinsatz kurz = Art.-Nr.: Ek...
* Sealing insert short = art. no.: Ek...

15590 | IT00710

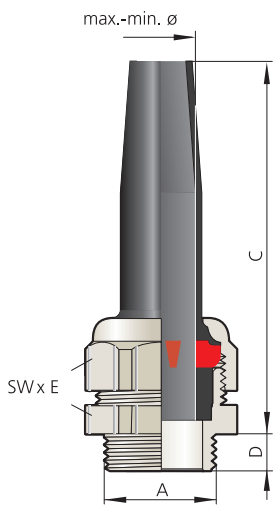
UNI Zoll Dicht-Kabelverschraubung

UNI Inch Dicht cable gland



Abb. 1
Fig. 1



Abb. 2
Fig. 2

Messing vernickelt
Zylindrisches Whitworth-Zoll-Gewinde DIN EN ISO 228-1
Mit O-Ring
Schutzart IP 68 bis 10 bar
Zugentlastung bis Klasse A, EN 62444

Brass, nickel-plated
Whitworth inch thread DIN EN ISO 228-1
With o-ring
Type of protection IP 68 up to 10 bar
Strain relief up to class A, EN 62444

Werkstoff Verschraubungskörper Material gland body	Ausführung/Farbe Version/colour	Werkstoff Dichteinsatz Material sealing insert	Farbe Colour	Bestellschlüssel Art. no. supplement	Temperaturbereich min./max. Temperature range (min./max.)
Messing Brass	Vernickelt Nickel-plated	TPE	s. FC s. CC		-40 °C / +130 °C
Messing Brass	Vernickelt Nickel-plated	TPE-V	Natur Natural	p	-40 °C / +135 °C
Messing Brass	Vernickelt Nickel-plated	Silikon HT Silicone HT	Schwarz Black	H	-55 °C / +200 °C



Abb. 3
Fig. 3

Anschlussgewinde/-länge Connection thread/length		Art.-Nr. Art. no.	Dichtbereich Sealing range	Bauhöhe Mounting height	Schlüsselweite Spanner width
		Ausführung bitte ergänzen Please complete product details			
		TPE =			
		TPE-V = p			
		Silikon HT/Silicone HT = H			
A	D mm	Art.-Nr.	max./min. ø mm	C mm	SW ₁ x E ₁ /SW ₂ x E ₂ mm
G1/4 "	6,0	101449d	7	6,5 – 4,0	17x18,9/14x15,5
G3/8 "	6,0	1038d	7 *	6,5 – 4,0	20x22,2
		1038d	9 *	9,5 – 6,5	20x22,2
G1/2 "	7,0	101252d	7	6,5 – 4,0	22x24,4
		101252d	8	8,0 – 5,0	22x24,4
		101252d	9	9,5 – 6,5	22x24,4
		101252d	11	10,5 – 7,0	22x24,4
		101252d	13	13,0 – 9,0	22x24,4
G3/4 "	9,0	103454d	11	10,5 – 7,0	30x33,5
		103454d	13	13,0 – 9,0	30x33,5
		103454d	16	15,5 – 11,5	30x33,5
		103454d	18	18,0 – 14,0	30x33,5
		103454d	20	20,5 – 17,0	30x33,5
G1 "	9,0	110054d	11	10,5 – 7,0	35x38,3/30x33,5
		110054d	13	13,0 – 9,0	35x38,3/30x33,5
		110054d	16	15,5 – 11,5	35x38,3/30x33,5
		110054d	18	18,0 – 14,0	35x38,3/30x33,5
		110054d	20	20,5 – 17,0	35x38,3/30x33,5
G1 1/4 "	9,0	1114d	30 *	30,0 – 26,0	45x48
G1 1/2 "	9,0	111256d	32	32,0 – 27,0	50x54
		111256d	34	34,0 – 29,0	50x54
		111256d	36	36,0 – 32,0	50x54
G2 "	10,0	120058d	44 *	44,0 – 39,0	64x69
G2 1/2 "	15,0	1212d	47 *	47,0 – 42,0	81x87
		1212d	52 *	52,0 – 45,0	81x87
		1212d	55 *	55,0 – 51,0	81x87
		1212d	58 *	58,0 – 54,0	81x87
G3 "	15,0	1300d	57 *	57,0 – 50,0	95x102
		1300d	64 *	64,0 – 58,0	95x102
		1300d	70 *	70,0 – 63,0	95x102

* Dichteinsatz aus Silikon HT nicht lieferbar
* Sealing insert silicone HT not available

UNI NPT Dicht-Kabelverschraubung

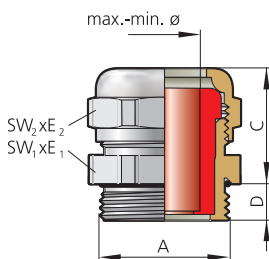
UNI NPT Dicht cable gland



Abb. 1
Fig. 1



Abb. 2
Fig. 2

Messing vernickelt
Kegeliges NPT-Gewinde ASAB 2.1-1960
Schutzart IP 68 bis 10 bar
Zugentlastung bis Klasse A, EN 62444

Brass, nickel-plated
Tapered NPT thread ASAB 2.1-1960
Type of protection IP 68 up to 10 bar
Strain relief up to class A, EN 62444

Metallrohre mit kegelförmigem NPT-Anschlussgewinde werden in den USA und Japan zum Kabelschutz in der Elektroinstallation verwendet. Das kegelförmige Außengewinde ist selbstdichtend bei kegelförmigem Innengewinde (gasdicht) ohne zusätzliche Maßnahmen zur Abdichtung. Das NPT-Gewinde ist gemäß ASAB 2.1-1960 genormt.

Metal pipes with conical NPT connection threads are used in the USA and Japan to protect cables in electrical installations. The conical external thread is self-sealing with the conical internal thread (gas-tight) without the use of additional measures to achieve the seal. The NPT thread is standardised in ASAB 2.1-1960.

Zur UNI NPT Dicht-Kabelverschraubung passen alle Einsatzdichtungen des PFLITSCH-Systems UNI Dicht für die Aufgaben:

- Erhöhte Zugentlastung
- Mehrfach
- Flache Kabel
- ASI-Bus-Kabel
- Biegeschutz
- Geschlossene Einsätze und Druckschrauben mit:
 - Schlauchstutzen
 - Zugentlastung
 - Federbiegeschutz

Suitable for UNI NPT Dicht cable glands are all insert sealings of the PFLITSCH UNI Dicht systems for the jobs:

- Increased strain relief
- Multiple
- Flat cables
- ASI-bus cables
- Bending protection
- Closed inserts and pressure screws with:
 - hose nozzles
 - strain relief
 - spring-bending protection

Werkstoff Verschraubungskörper Material gland body	Ausführung/Farbe Version/colour	Werkstoff Dichteinsatz Material sealing insert	Farbe Colour	Bestellschlüssel Art. no. supplement	Temperaturbereich min./max. Temperature range (min./max.)
Messing Brass	Vernickelt Nickel-plated	TPE	s. FC s. CC		-40 °C / +130 °C
Messing Brass	Vernickelt Nickel-plated	TPE-V	Natur Natural	p	-40 °C / +135 °C
Messing Brass	Vernickelt Nickel-plated	Silikon HT Silicone HT	Schwarz Black	H	-55 °C / +200 °C



Abb. 3
Fig. 3

Anschlussgewinde/-länge Connection thread/length	Art.-Nr. Art. no.	Dichtbereich Sealing range	Bauhöhe Mounting height	Schlüsselweite Spanner width			
Ausführung bitte ergänzen Please complete product details							
A	TPE =	max./min. ø mm	C mm	SW ₁ x E ₁ /SW ₂ x E ₂ mm			
	TPE-V = p						
	Silikon HT/Silicone HT = H						
NPT3/8 "	13,0	303851d	7	6,5– 4,0	28,0	20x22,2	50
		303851d	8 *	8,0– 5,0	28,0	20x22,2	50
		303851d	9	9,5– 6,5	28,0	20x22,2	50
		303851d	11	10,5– 7,0	28,0	20x22,2	50
NPT1/2 "	16,0	301253d	7	6,5– 4,0	28,0	24x26,7/22x24,4	50
		301253d	8	8,0– 5,0	28,0	24x26,7/22x24,4	50
		301253d	9	9,5– 6,5	28,0	24x26,7/22x24,4	50
		301253d	11	10,5– 7,0	28,0	24x26,7/22x24,4	50
		301253d	13	13,0– 9,0	28,0	24x26,7/22x24,4	50
		301253d	16	15,5– 11,5	28,0	24x26,7/22x24,4	50
NPT3/4 "	16,0	303454d	11	10,5– 7,0	35,0	30x33,5	25
		303454d	13	13,0– 9,0	35,0	30x33,5	25
		303454d	16	15,5– 11,5	35,0	30x33,5	25
		303454d	18	18,0– 14,0	35,0	30x33,5	25
		303454d	20	20,5– 17,0	35,0	30x33,5	25
NPT1 "	20,0	310055d	16	15,5– 11,5	39,0	40x43,5	10
		310055d	18	18,0– 14,0	39,0	40x43,5	10
		310055d	20	20,5– 17,0	39,0	40x43,5	10
		310055d	25	25,0– 20,0	39,0	40x43,5	10
		310055d	28	28,0– 24,0	39,0	40x43,5	10
NPT1 1/4 "	20,0	311456d	32	32,0– 27,0	40,0	50x54	10
		311456d	34	34,0– 29,0	40,0	50x54	10
		311456d	36	36,0– 32,0	40,0	50x54	10
NPT1 1/2 "	22,0	311257d	36 *	36,0– 32,0	40,0	57x61,5	5
		311257d	40 *	40,0– 36,0	40,0	57x61,5	5
NPT2 "	25,0	320058d	44 *	44,0– 39,0	40,0	64x69	1

* Dichteinsatz aus Silikon HT nicht lieferbar

* Sealing insert silicone HT not available

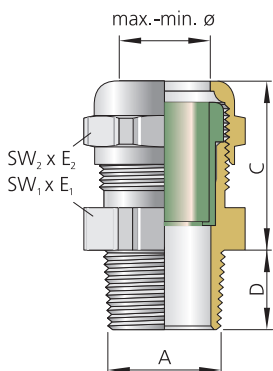
Übersichtstabelle für die UNI Dicht-Komponenten – Pg

Overview of UNI Dicht components – Pg

Messing vernickelt, Edelstahl 1.4305, Polycarbonat: Farbe grau (RAL 7035), PVDF: Farbe transparent, mit Pg-Gewinde, Schutzart IP 68 bis 10 bar

Brass, nickel-plated, stainless steel AISI 303, Polycarbonate: colour grey (RAL 7035), PVDF: colour transparent, with Pg connecting thread, type of protection: IP 68 up to 10 bar

Anschlussgewinde Connection thread	Messing vernickelt Brass, nickel-plated			Edelstahl 1.4305 Stainless steel AISI 303			Polycarbonat Polycarbonate
	DS ¹⁾	DN ¹⁾	VK ¹⁾	DS ¹⁾	DN ¹⁾	VK ¹⁾	DS ¹⁾
Pg 7	DS 149d	DN 149d	VK 149d	DS 149st	DN 149st	VK 149st	DS 149PC
Pg 7	DS 150d	DN 14950d	VK 14950d				DS 150PC
Pg 7	DS 151d	DN 14951d	VK 14951d				
Pg 9	DS 150d	DN 150d	VK 150d	DS 150st	DN 150st	VK 150st	DS 150PC
Pg 9	DS 151d	DN 15051d	VK 15051d				DS 151PC
Pg 9	DS 152d	DN 15052d	VK 15052d				
Pg 9	DS 153d	DN 15053d	VK 15053d				
Pg 11	DS 151d	DN 151d	VK 151d	DS 151st	DN 151st	VK 151st	DS 151PC
Pg 11	DS 152d	DN 15152d	VK 15152d				DS 152PC
Pg 11	DS 153d	DN 15153d	VK 15153d				
Pg 11							
Pg 13,5	DS 152d	DN 152d	VK 152d	DS 152st	DN 152st	VK 152st	DS 152PC
Pg 13,5	DS 153d	DN 15253d	VK 15253d				DS 153PC
Pg 13,5	DS 154d18	DN 15254d	VK 15254d18				DS 154PC
Pg 13,5	DS 154d21	DN 15254d	VK 15254d21				
Pg 16	DS 153d	DN 153d	VK 153d	DS 153st	DN 153st	VK 153st	DS 153PC
Pg 16	DS 154d18	DN 15354d	VK 15354d18				DS 154PC
Pg 16	DS 154d21	DN 15354d	VK 15354d21				
Pg 16							

1) Abkürzungen siehe Seite 138 bis 143 * Werkstoff POM (Farbe weiß), Temperaturbereich: -40 °C bis +110 °C.

1) Abbreviations see page 138 to 143 * Material POM (white colour), temperature range: -40 °C up to +110 °C

Polycarbonat <i>Polycarbonate</i>		PVDF <i>PVDF</i>			Dichteinsätze <i>Sealing inserts</i>			
DN¹⁾	VK¹⁾	DS¹⁾	DN¹⁾	VK¹⁾	TPE	TPE-V	Silikon <i>silicone</i>	TPE geschlossen <i>TPE closed</i>
DN 149PC	VK 149PC	DS 149y	DN 149y	VK 149y	E 149/ 7	E 149p 7	E 149i 7 HF/HT	E 149g
DN 14950PC	VK 14950PC	DS 150y	DN 14950y	VK 14950y	Ek150/ 8	Ek150p 8	E 150i 8 HF/HT	Ek150g
					Ek150/ 9	Ek150p 9	E 150i 9 HF/HT	
					Ek151/ 8	Ek151p 8		Ek151g
					Ek151/ 9	Ek151p 9	E 151i 9 HF/HT	
					Ek151/11	Ek151p11	E 151i11 HF/HT	
DN 150PC	VK 150PC	DS 150y	DN 150y	VK 150y	E 150/ 7	E 150p 7	E 150i 7/HT	E 150g
					E 150/ 8	E 150p 8	E 150i 8/HT	
					E 150/ 9	E 150p 9	E 150i 9/HT	
DN 15051PC	VK 15051PC	DS 151y	DN 15051y	VK 15051y	Ek151/11	Ek151p11	E 151i11 HF/HT	Ek151g
		DS 152y	DN 15052y	VK 15052y	Ek152/11	Ek152p11	E 152i11 HF/HT	Ek152g
					Ek152/13	Ek152p13	E 152i13 HF/HT	
					Ek153/11	Ek153p11	E 153i11 HF/HT	Ek153g
					Ek153/13	Ek153p13	E 153i13 HF/HT	
					Ek153/16	Ek153p16	E 153i16 HF/HT	
DN 151PC	VK 151PC	DS 151y	DN 151y	VK 151y	E 151/ 7	E 151p 7	E 151i 7/HT	E 151g
					E 151/ 8	E 151p 8		
					E 151/ 9	E 151p 9	E 151i 9/HT	
					E 151/11	E 151p11	E 151i11/HT	
DN 15152PC	VK 15152PC	DS 152y	DN 15152y	VK 15152y	Ek152/13	Ek152p13	E 152i13 HF/HT	Ek152g
		DS 153y	DN 15153y	VK 15153y	Ek153/13	Ek153p13	E 153i13 HF/HT	Ek153g
					Ek153/16	Ek153p16	E 153i16 HF/HT	
		DS 154y	DN 15154p *	VK 15154p *	Ek154/13	Ek154p13	E 154i13 HF/HT	Ek154g
					Ek154/16	Ek154p16	E 154i16 HF/HT	
					Ek154/18	Ek154p18	E 154i18 HF/HT	
					Ek154/20	Ek154p20	E 154i20 HF/HT	
DN 152PC	VK 152PC	DS 152y	DN 152y	VK 152y	E 152/ 7	E 152p 7	E 152i 7/HT	E 152g
					E 152/ 8	E 152p 8	E 152i 8/HT	
					E 152/ 9	E 152p 9	E 152i 9/HT	
					E 152/11	E 152p11	E 152i11/HT	
					E 152/13	E 152p13	E 152i13/HT	
DN 15253PC	VK 15253PC	DS 153y	DN 15253y	VK 15253y	Ek153/16	Ek153p16	E 153i16 HF/HT	Ek153g
DN 15254PC	VK 15254PC	DS 154y	DN 15254y	VK 15254y	Ek154/16	Ek154p16	E 154i16 HF/HT	Ek154g
					Ek154/18	Ek154p18	E 154i18 HF/HT	
					Ek154/20	Ek154p20	E 154i20 HF/HT	Ek154g
DN 153PC	VK 153PC	DS 153y	DN 153y	VK 153y	E 153/ 7	E 153p 7	E 153i 7/HT	E 153g
					E 153/ 8	E 153p 8	E 153i 8/HT	
					E 153/ 9	E 153p 9	E 153i 9/HT	
					E 153/11	E 153p11	E 153i11/HT	
					E 153/13	E 153p13	E 153i13/HT	
					E 153/16	E 153p16	E 153i16/HT	
DN 15354PC	VK 15354PC	DS 154y	DN 15354y	VK 15354y	Ek154/16	Ek154p16	E 154i16 HF/HT	Ek154g
					Ek154/18	Ek154p18	E 154i18 HF/HT	
					Ek154/20	Ek154p20	E 154i20 HF/HT	Ek154g
		DS 155y	DN 15355y	VK 15355y	Ek155/18	Ek155p18	E 155i18 HF/HT	Ek155g
					Ek155/20	Ek155p20	E 155i20 HF/HT	
					Ek155/25	Ek155p25	E 155i25 HF/HT	
					Ek155/28	Ek155p28	E 155i28 HF/HT	

 Fortsetzung auf der nächsten Seite ►
 Continued on next page

Übersichtstabelle für die UNI Dicht-Komponenten – Pg

Overview of UNI Dicht components – Pg

Messing vernickelt, Edelstahl 1.4305, Polycarbonat: Farbe grau (RAL 7035), PVDF: Farbe transparent, mit Pg-Gewinde, Schutzart IP 68 bis 10 bar

Brass, nickel-plated, stainless steel AISI 303, Polycarbonate: colour grey (RAL 7035), PVDF: colour transparent, with Pg connecting thread, type of protection: IP 68 up to 10 bar

◀ Fortsetzung von vorheriger Seite
Continued from previous page

Anschlussgewinde Connection thread	Messing vernickelt Brass, nickel-plated			Edelstahl 1.4305 Stainless steel AISI 303			Polycarbonat Polycarbonate
	DS ¹⁾	DN ¹⁾	VK ¹⁾	DS ¹⁾	DN ¹⁾	VK ¹⁾	DS ¹⁾
Pg 21	DS 152d	DN 15452d	VK 15452d				
Pg 21	DS 153d	DN 15453d	VK 15453d				
Pg 21	DS 154d18	DN 154d	VK 154d	DS 154st18	DN 154st	VK 154st	DS 154PC
Pg 21	DS 154d21	DN 154d	VK 154d20	DS 154st21	DN 154st	VK 154st20	DS 154PC
Pg 21	DS 155d	DN 15455d	VK 15455d				
Pg 21							
Pg 29	DS 153d	DN 15553d	VK 15553d				
Pg 29	DS 154d18	DN 15554d	VK 15554d				
Pg 29	DS 155d	DN 155d	VK 155d	DS 155st	DN 155st	VK 155st	DS 155PC
Pg 29	DS 156d	DN 15556d	VK 15556d				DS 156PC
Pg 36	DS 155d	DN 15655d	VK 15655d				
Pg 36	DS 156d	DN 156d	VK 156d	DS 156st	DN 156st	VK 156st	DS 156PC
Pg 36	DS 157d	DN 15657d	VK 15657d				
Pg 42	DS 157d	DN 157d	VK 157d	DS 157st	DN 157st	VK 157st	
Pg 48	DS 158d	DN 158d	VK 158d	DS 158st	DN 158st	VK 158st	

1) Abkürzungen siehe Seite 138 bis 143 * Werkstoff POM (Farbe weiß), Temperaturbereich: -40 °C bis +110 °C.

1) Abbreviations see page 138 to 143 * Material POM (white colour), temperature range: -40 °C up to +110 °C

Polycarbonat Polycarbonate		PVDF PVDF			Dichteinsätze Sealing inserts			
DN ¹⁾	VK ¹⁾	DS ¹⁾	DN ¹⁾	VK ¹⁾	TPE	TPE-V	Silikon silicone	TPE geschlossen TPE closed
					E 152/ 7	E 152p 7	E 152i 7/HT	E 152g
					E 152/ 8	E 152p 8	E 152i 8/HT	
					E 152/ 9	E 152p 9	E 152i 9/HT	
					E 153/ 7	E 153p 7	E 153i 7/HT	E 153g
					E 153/ 8	E 153p 8	E 153i 8/HT	
					E 153/ 9	E 153p 9	E 153i 9/HT	
DN 154PC	VK 154PC	DS 154y	DN 154y	VK 154y	E 154/11	E 154p11	E 154i11/HT	E 154g
					E 154/13	E 154p13	E 154i13/HT	
					E 154/16	E 154p16	E 154i16/HT	
					E 154/18	E 154p18	E 154i18/HT	
DN 154PC	VK 154PC	DS 154y	DN 154y	VK 154y	E 154/20	E 154p20	E 154i20/HT	E 154g
					Ek155/25	Ek155p25	E 155i25 HF/HT	Ek155g
					Ek155/28	Ek155p28	E 155i28 HF/HT	
		DS 156y	DN 15456y	VK 15456y	Ek156/32	Ek156p32	E 156i32 HF/HT	Ek156g
					Ek156/34	Ek156p34	E 156i34 HF/HT	
					Ek156/36	Ek156p36	E 156i36 HF/HT	
					E 153/ 7	E 153p 7	E 153i 7/HT	E 153g
					E 153/ 8	E 153p 8	E 153i 8/HT	
					E 153/ 9	E 153p 9	E 153i 9/HT	
					E 153/11	E 153p11	E 153i11/HT	
					E 153/13	E 153p13	E 153i13/HT	
					Ek154/11	Ek154p11	E 154i11/HT	Ek154g
					Ek154/13	Ek154p13	E 154i13 HF/HT	
DN 155PC	VK 155PC	DS 155y	DN 155y	VK 155y	E 155/16	E 155p16	E 155i16/HT	E 155g
					E 155/18	E 155p18	E 155i18/HT	
					E 155/20	E 155p20	E 155i20/HT	
					E 155/25	E 155p25	E 155i25/HT	
					E 155/28	E 155p28	E 155i28/HT	
DN 15556PC	VK 15556PC	DS 156y	DN 15556y	VK 15556y	Ek156/32	Ek156p32	E 156i32 HF/HT	Ek156g
					Ek156/34	Ek156p34	E 156i34 HF/HT	
					Ek156/36	Ek156p36	E 156i36 HF/HT	
					E 155/16	E 155p16	E 155i16/HT	E 155g
					E 155/18	E 155p18	E 155i18/HT	
					E 155/20	E 155p20	E 155i20/HT	
					E 155/25	E 155p25	E 155i25/HT	
					E 155/28	E 155p28	E 155i28/HT	
DN 156PC	VK 156PC	DS 156y	DN 156y	VK 156y	E 156/32	E 156p32	E 156i32/HT	E 156g
					E 156/34	E 156p34	E 156i34/HT	
					E 156/36	E 156p36	E 156i36/HT	
					E 157/40 HF	E 157p40 HF		Ek157g
		DS 157p *	DN 157p *	VK 157p *	E 157/40	E 157p40		E 157g
		DS 158p *	DN 158p *	VK 158y	E 158/44	E 158p44		E 158g

