

Data Sheet | Item Number: 216-103

Ferrule; Sleeve for 1 mm² / AWG 18; uninsulated; electro-tin plated

<https://www.wago.com/216-103>

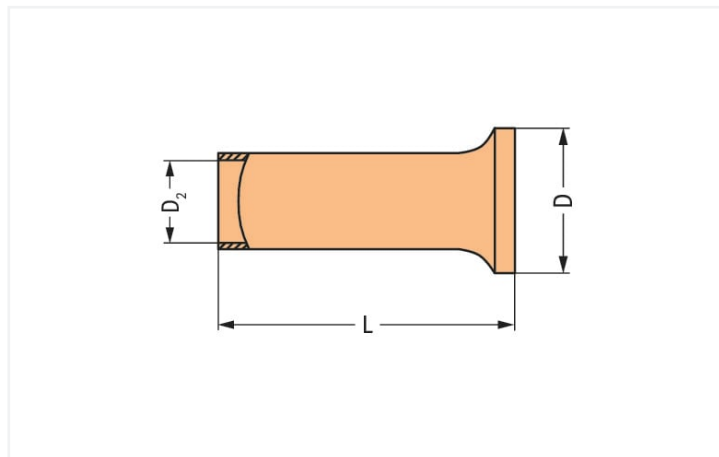

Dimensions in mm

Technical data

Sleeve cross-section (AWG)	18 AWG
Sleeve for	1 mm ²

Connection data

Strip length	8 mm / 0.31 inches
--------------	--------------------

Physical data

Length	8 mm
Diameter	2.5 mm
Diameter crimp sleeve inside	1.4 mm

Material data

Fire load	0 MJ
Weight	0.1 g

Commercial data

Product Group	2 (Terminal Block Accessories)
eCl@ss 10.0	27-40-02-01
eCl@ss 9.0	27-40-02-01
ETIM 8.0	EC000005
ETIM 7.0	EC000005
PU (SPU)	5000 (1000) pcs
Packaging type	Box
Country of origin	DE
GTIN	4017332277655
Customs tariff number	85369010000

Environmental Product Compliance

RoHS Compliance Status	Compliant, No Exemption
------------------------	-------------------------

Downloads

Environmental Product Compliance

Compliance Search	
Environmental Product Compliance 216-103	↓

Documentation

Bid Text			
216-103	11.09.2017	doc 24.50 KB	↓
216-103	19.02.2019	xml 2.77 KB	↓

Installation Notes

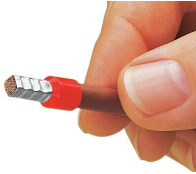

A perfect gas-tight crimp – both electrical-ly and mechanically reliable