

## Data Sheet | Item Number: 216-203

Ferrule; Sleeve for 1 mm<sup>2</sup> / AWG 18; insulated; electro-tin plated; red

<https://www.wago.com/216-203>



Color: ■ red

Similar to illustration

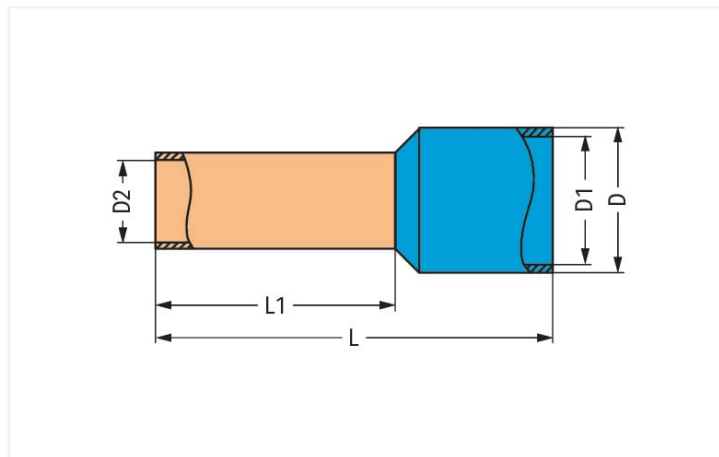

Dimensions in mm

### Technical data

Sleeve cross-section (AWG)	18 AWG
Sleeve for	1 mm <sup>2</sup>

### Connection data

Strip length	10 mm / 0.39 inches
--------------	---------------------

### Physical data

Length	14 mm
Crimp length (length of sleeve)	8 mm
Diameter	3.5 mm
Inner Diameter plastic collar	3 mm
Diameter crimp sleeve inside	1.4 mm

### Material data

Color	red
Fire load	0.001 MJ
Weight	0.1 g

### Commercial data

Product Group	2 (Terminal Block Accessories)
eCl@ss 10.0	27-40-02-01
eCl@ss 9.0	27-40-02-01
ETIM 8.0	EC000005
ETIM 7.0	EC000005
PU (SPU)	1000 (100) pcs
Packaging type	Box
Country of origin	DE
GTIN	4017332277471
Customs tariff number	85369010000

### Environmental Product Compliance

RoHS Compliance Status	Compliant, No Exemption
------------------------	-------------------------

### Downloads

#### Environmental Product Compliance

Compliance Search	
Environmental Product Compliance 216-203	<a href="#">↓</a>

### Documentation

Bid Text			
216-203	19.02.2019	xml 2.80 KB	<a href="#">↓</a>
216-203	11.09.2017	doc 24.00 KB	<a href="#">↓</a>

### Installation Notes



A perfect gas-tight crimp – both electrical-ly and mechanically reliable