

Data Sheet | Item Number: 216-206

Ferrule; Sleeve for 2.5 mm² / AWG 14; insulated; electro-tin plated; blue

<https://www.wago.com/216-206>



Color: ■ blue

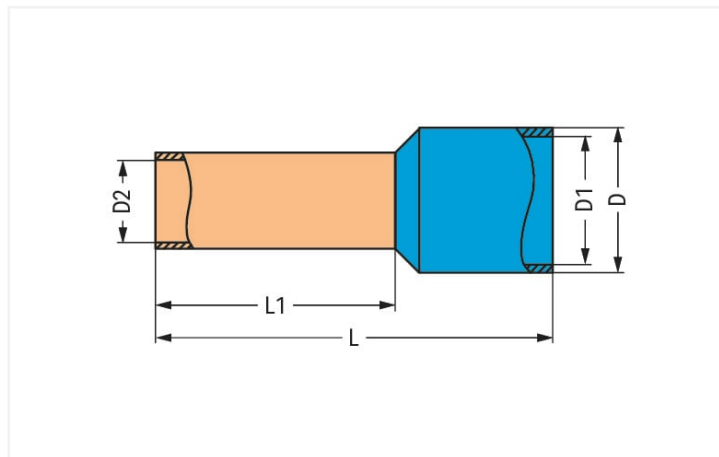

Dimensions in mm

Technical data

Sleeve cross-section (AWG)	14 AWG
Sleeve for	2.5 mm ²

Connection data

Strip length	10 mm / 0.39 inches
--------------	---------------------

Physical data

Length	15 mm
Crimp length (length of sleeve)	8 mm
Diameter	4.7 mm
Inner Diameter plastic collar	4.2 mm
Diameter crimp sleeve inside	2.2 mm

Material data

Color	blue
Fire load	0.002 MJ
Weight	0.2 g

Commercial data

Product Group	2 (Terminal Block Accessories)
eCl@ss 10.0	27-40-02-01
eCl@ss 9.0	27-40-02-01
ETIM 8.0	EC000005
ETIM 7.0	EC000005
PU (SPU)	1000 (100) pcs
Packaging type	Box
Country of origin	DE
GTIN	4017332277518
Customs tariff number	85369010000

Environmental Product Compliance

RoHS Compliance Status

Compliant, No Exemption

Downloads

Environmental Product Compliance

Compliance Search

Environmental Product
Compliance 216-206



Documentation

Bid Text

216-206	19.02.2019	xml 2.80 KB	
216-206	11.09.2017	doc 24.50 KB	

Installation Notes

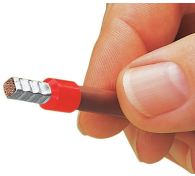

A perfect gas-tight crimp – both electrical-ly and mechanically reliable

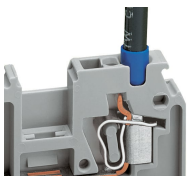

Using a 12 AWG conductor with ferrule
(Item No. 216-206).