

Data Sheet | Item Number: 890-102

Socket; with strain relief housing; 2-pole; Cod. A; 1,50 mm²; black

<https://www.wago.com/890-102>



Color: ■ black

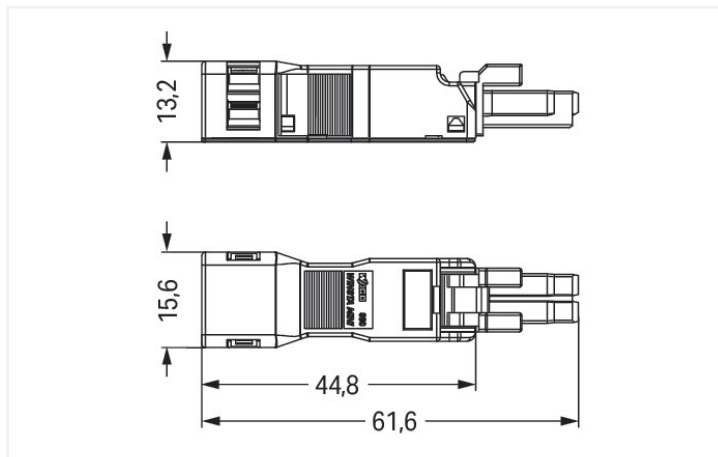

Dimensions in mm

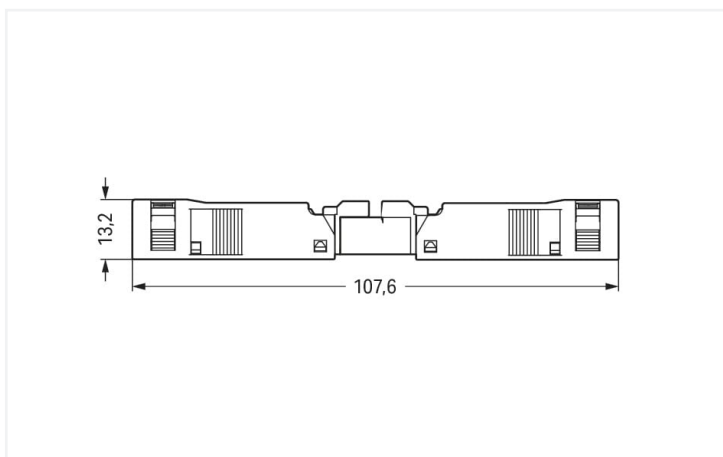

Dimensions in mm

Overall length when mated

Female connector/socket WINSTA® MINI 2-pole

The WINSTA® MINI female connector/socket with protection against mismatching allows installation of fine-stranded and solid conductors. WAGO pluggable installation connectors are used when specifications repeat or are distributed on a specific grid, for example for installing grid lighting or flush-mount lighting. The coding options reduce installation errors, allowing fast, maintenance-free wiring of all components. The pluggable installation connector is protected in accordance with protection type IP40. Users' hands and tools will never come into contact with live elements. Standard mains applications for almost any domain of use can be implemented with WINSTA® MINI pluggable installation connectors with A coding. Particularly where space is tight, our smallest pluggable connection system, WINSTA® MINI, consistently displays its advantageous properties. It is very compact, and, with Push-in CAGE CLAMP® spring pressure connection technology, it also saves time, since the installation is low-maintenance and requires no screw connections. A range up to 32 mm can be used for the strip length.

Push-in CAGE CLAMP® spring pressure connection technology – pluggable installation instead of laborious screw connections!

WINSTA® is the pluggable connection system that is optimally tailored to the strict requirements of electrical installation. It ensures fast, secure and, above all, error-free installation of components and cables. Choose quality and durability – with strain relief hosting from WAGO makes the electrical installation of electrical components noticeably easier.

- effective protection against mismatching
- consistent IP40 protection
- with A coding for use in many general mains applications
- custom-engineered solutions
- fast, secure installation

This item includes:



Item No.: 890-202

1

Socket; 2-pole; Cod. A; 1,50 mm²; black

Item No.: 890-502

1

Strain relief housing; 2-pole; with locking clip; for 1 cable; 3.8 ... 8.2 mm; 30 mm; black

Electrical data

Ratings per	IEC/EN 60664-1		
Overvoltage category	III	III	II
Pollution degree	3	2	2
Nominal voltage	250 V	-	-
Rated surge voltage	4 kV	-	-
Rated current	16 A	-	-

Approvals per	UL 1977
Rated voltage	600 V
Rated current	14 A

General information

Note on contact resistance	approx. 1 mΩ of contact resistance approx. 0.25 mΩ contact transition plug/ socket
----------------------------	--

Connection data

Connection points	2
Total number of potentials	2

Connection 1	
Connection technology	Push-in CAGE CLAMP®
Actuation type	Operating tool Push-in
Nominal cross-section	1.5 mm ² / 16 AWG
Solid conductor	0.25 ... 1.5 mm ² / 22 ... 16 AWG
Solid conductor; push-in termination	0.75 ... 1.5 mm ² / 20 ... 16 AWG
Stranded conductor	0.25 ... 1 mm ² / 22 ... 18 AWG
Fine-stranded conductor	0.25 ... 1.5 mm ² / 22 ... 16 AWG
Fine-stranded conductor; with insulated ferrule	0.25 ... 0.75 mm ² / 22 ... 20 AWG
Fine-stranded conductor; with uninsulated ferrule	0.25 ... 0.75 mm ² / 22 ... 20 AWG
Fine-stranded conductor; with ferrule; push-in termination	0.75 mm ² / 20 AWG
Strip length	9 mm / 0.35 inches
Pole number	2
Connectable sheathed cable diameter	3.8 ... 8.2 mm
Conductor entry direction to mating direction	0°
Strip length (outer insulation)	32 mm

Physical data

Pin spacing	4.4 mm / 0.173 inches
Width	15.6 mm / 0.614 inches
Height	13.2 mm / 0.52 inches
Depth	61.6 mm / 2.425 inches

Mechanical data

Application	General mains applications
Coding	A
Variable coding	No
Marking	L N
Potential marking	L N
Mating force of a plug-in connection	approx. 20 ... 70 N (depending on pole number)
Retention force of a plug-in connection	Locked: > 80 N
Unmating force of a plug-in connection	Unlocked: approx. 20 ... 70 N (depending on pole number)
Number of mating cycles	200, without resistive load
Protection type	IP40

Plug-in connection

Contact type (pluggable connector)	Female connector/socket
Connector (connection type)	for conductor
Mismating protection	Yes
Note on mismating protection	All WINSTA® components are 100% protected against mismating when: a.) plugging different numbers of poles b.) plugging while rotated 180 c.) plugging while laterally staggered d.) plugging one pole
Locking lever	Can be retrofitted
Locking of plug-in connection	Locking lever
Note on locking system	All connectors for mounted installations (snap-in versions for lighting fixtures or devices, all types of PCB and distribution connectors) are factory-equipped with locking levers to ensure plugs and sockets are securely locked. Additional locking levers are only required for flying leads (plug/socket).
Strain relief	Strain relief housing

Material data

Note (material data)	Information on material specifications can be found here
Color	black
Cover color	gray
Material group	I
Insulation material	Polyamide (PA66)
Flammability class per UL94	V0
Clamping spring material	Chrome-nickel spring steel (CrNi)
Contact material	Copper or copper alloy; surface-treated
Contact plating	Tin
Fire load	0.196 MJ
Connector color	black
Strain relief color	black
Weight	5.7 g

Environmental requirements

Processing temperature	-5 ... +40 °C
Continuous operating temperature	-35 ... +85 °C
Note on continuous operating temperature	Insulating parts for temperatures ≤ 105 °C

Commercial data

Product Group	20 (Winsta)
eCl@ss 10.0	27-44-06-05
eCl@ss 9.0	27-44-06-05
ETIM 8.0	EC002560
ETIM 7.0	EC002560
PU (SPU)	50 pcs
Packaging type	Box
Country of origin	DE
GTIN	4045454231729
Customs tariff number	85366990990

Environmental Product Compliance

RoHS Compliance Status	Compliant, No Exemption
------------------------	-------------------------

Approvals / Certificates

General approvals



Approval	Standard	Certificate Name
CCA DEKRA Certification B.V.	EN 61535	71-123231
CCA DEKRA Certification B.V.	IEC 61535	NL-85020
cURus Underwriters Laboratories Inc.	UL 1977	E45171

Declarations of conformity and manufacturer's declarations

Approval	Standard	Certificate Name
EU-Declaration of Confor- mity WAGO GmbH & Co. KG	-	-
UK-Declaration of Confor- mity WAGO GmbH & Co. KG	-	-

Approvals for marine applications



Approval	Standard	Certificate Name
ABS American Bureau of Ship- ping	Steel Vessel Rules	19-HG1869855-PDA
DNV GL Det Norske Veritas, Ger- manischer Lloyd	-	TAE00001Z6
LR Lloyds Register	EN 61535	08/20047 (E2)

Downloads

Environmental Product Compliance

Compliance Search			
Environmental Product Compliance 890-102			↓

Documentation

Bid Text			
890-102	08.06.2015	doc 23.00 KB	↓
890-102	19.02.2019	xml 3.03 KB	↓

CAD/CAE-Data

CAD data	
2D/3D Models 890-102	↓

CAE data	
EPLAN Data Portal 890-102	↓
WSCAD Universe 890-102	↓
ZUKEN Portal 890-102	↓

1 Compatible Products

1.1 System counterpart

1.1.1 Cable assembly



Item No.: 891-8992/205-101
pre-assembled connecting cable; Eca; Plug/open-ended; 2-pole; Cod. A; H05VV-F 2 x 1.0 mm²; 1 m; 1,00 mm²; black

Item No.: 891-8992/005-101
pre-assembled interconnecting cable; Eca; Socket/plug; 2-pole; Cod. A; H05VV-F 2 x 1.0 mm²; 1 m; 1,00 mm²; black

1.1.2 Distribution connector



Item No.: 890-1634
h-distribution connector; 2-pole; Cod. A; 1 input; 2 outputs; outputs on one side; 2 locking levers; black

Item No.: 890-1636
h-distribution connector; 2-pole; Cod. A; 1 input; 2 outputs; outputs on one side; 3 locking levers; for flying leads; black

Item No.: 890-1606
T-distribution connector; 2-pole; Cod. A; 1 input; 2 outputs; 2 locking levers; black

Item No.: 890-1615
T-distribution connector; 2-pole; Cod. A; 1 input; 2 outputs; 3 locking levers; for flying leads; black

1.1.3 Male connector/plug



Item No.: 890-812/011-000
 Plug for PCBs; angled; 2-pole; Cod. A; black

Item No.: 890-812
 Plug for PCBs; straight; 2-pole; Cod. A; black

Item No.: 890-212
 Plug; 2-pole; Cod. A; 1,50 mm²; black

Item No.: 890-112
 Plug; with strain relief housing; 2-pole; 1,50 mm²; black



Item No.: 890-212/342-000
 Plug; with strain relief housing; 2-pole; Cod. A; 1,50 mm²; black

Item No.: 890-712
 Snap-in plug; 2-pole; Cod. A; 1,50 mm²; black

1.2 Required Accessories

1.2.1 Locking system

1.2.1.1 Locking system



Item No.: 890-111
 Locking lever; for flying leads; for tool operation; black

Item No.: 890-131
 Locking lever; for flying leads; for tool operation; white

Item No.: 890-101
 Locking lever; for manual operation; black

Item No.: 890-121
 Locking lever; for manual operation; white

1.3 Optional Accessories

1.3.1 Cover

1.3.1.1 Cover



Item No.: 897-2001
 Protective cap; Type1; for sockets and plugs; PVC; red

1.3.2 Installation

1.3.2.1 Mounting accessories



Item No.: 890-310
 Mounting carrier; 2- to 5-pole; for flying leads; black

Item No.: 890-311
 Mounting carrier; 2- to 5-pole; for flying leads; white

1.3.3 Tool

1.3.3.1 Operating tool



Item No.: 890-382
 Operating tool; 2-way; green

Item No.: 210-719
 Operating tool; Blade: 2.5 x 0.4 mm; with a partially insulated shaft

Installation Notes

Conductor termination

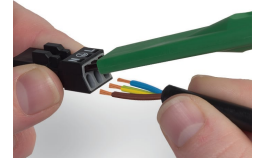
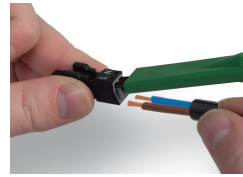
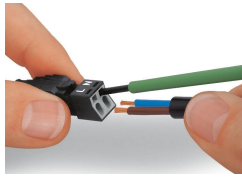

1. Strip length, outer insulation = 30 mm (2-pole), 37 mm (3-pole), 45 mm (4- and 5-pole)
2. Strip length = 9 mm
3. Extended ground conductor = 8 mm

To terminate fine-stranded conductors, open the clamping unit via screwdriver – 2.5 mm blade width – and insert a stripped conductor until it hits the backstop. Terminate solid conductors by simply pushing them in.

To terminate fine-stranded conductors, open clamping units via operating tool (890-382) and insert stripped conductors until they hit backstop. Terminate solid conductors by simply pushing them in.

To terminate fine-stranded conductors, open clamping units via operating tool (890-383) and insert stripped conductors until they hit backstop. Terminate solid conductors by simply pushing them in.

Installation

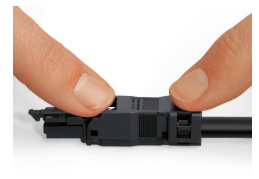
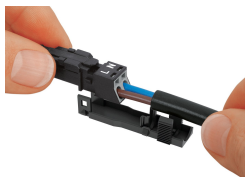

Latch the wired connector into the base of the strain relief housing.

Push down strain relief clamp by hand.

Push down strain relief clamp with 2.5 mm screwdriver alternately on both sides.

Latch the top of the strain relief housing.



The printed marking of the connector is clearly visible in the openings of the strain relief housing.