

Data Sheet | Item Number: 890-103

Socket; with strain relief housing; 3-pole; Cod. A; 1,50 mm²; black

<https://www.wago.com/890-103>



Color: ■ black

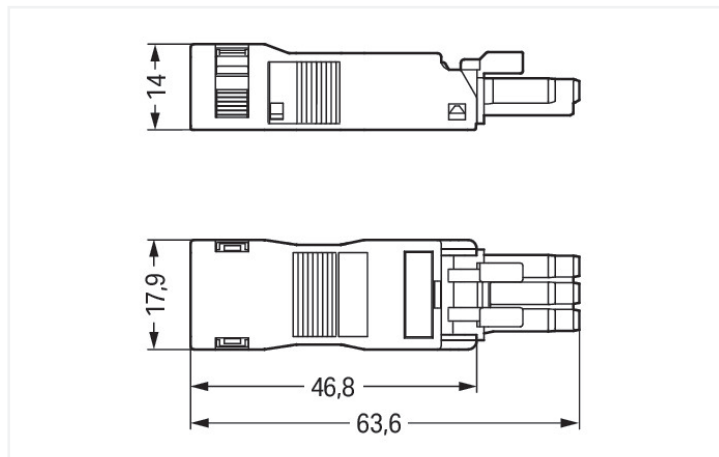

Dimensions in mm

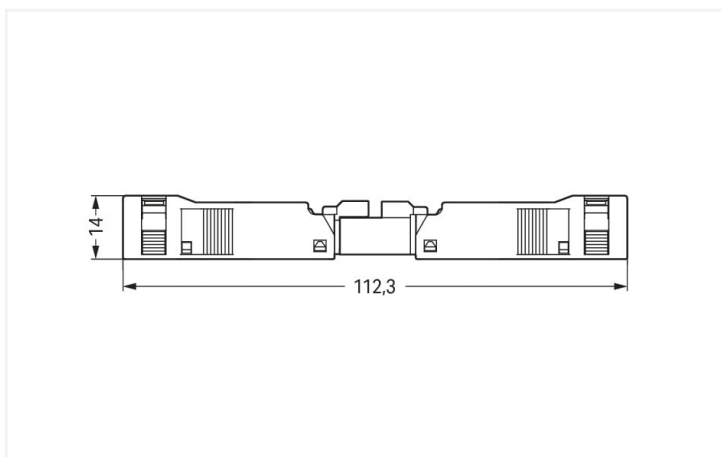

Dimensions in mm

Overall length when mated

Female connector/socket *WINSTA*® MINI A coding

Use effective pluggable connections instead of laborious screw connections: With the *WINSTA*® MINI female connector/socket rated current 16 A. Our pluggable installation connectors with spring pressure connection technology function completely without screw connections. They allow resource-efficient, error-free installation in numerous possible uses. The color coding and mechanical coding of the pluggable installation connector ensure error-free installation of the individual components – including protection against mismatching. The pluggable installation connector offers protection against contact with wires or tools if they are smaller than 1 mm in accordance with protection type IP40. Thanks to the color coding and mechanical A coding of *WINSTA*® MINI pluggable installation connectors, you can clearly distinguish different circuits. Thanks to its particularly small dimensions, our *WINSTA*® MINI Pluggable Connection System with Push-in *CAGE CLAMP*® spring pressure connection technology is very suitable in very restricted spaces, i. e., for connections when very little room is available. The strip length is 40 mm.

Push-in *CAGE CLAMP*® spring pressure connection technology – pluggable installation instead of laborious screw connections!

WINSTA® is the pluggable connection system that is ideally tailored to the strict requirements of electrical installation. It allows fast, secure and, above all, error-free installation of components and cables. Now you can also cut installation expenses without compromising quality and safety: with protection type IP40 eliminates the need for servicing and prevents unnecessary downtime.

- protection against mismatching eliminates errors
- consistent IP40 protection
- suitable for any application
- flexible installation to save space
- rapid, structured electrical installation

This item includes:



Item No.: 890-203

1

Socket; 3-pole; Cod. A; 1,50 mm²; black

Item No.: 890-503

1

Strain relief housing; 3-pole; with locking clip; for 1 cable; 4.5 ... 10.0 mm; 37 mm; black

Electrical data

Ratings per	IEC/EN 60664-1		
Overvoltage category	III	III	II
Pollution degree	3	2	2
Nominal voltage	250 V	-	-
Rated surge voltage	4 kV	-	-
Rated current	16 A	-	-

Approvals per	UL 1977
Rated voltage	600 V
Rated current	14 A

General information

Note on contact resistance	approx. 1 mΩ of contact resistance approx. 0.25 mΩ contact transition plug/ socket
----------------------------	--

Connection data

Clamping units	3
Total number of potentials	3

Connection 1	
Connection technology	Push-in CAGE CLAMP®
Actuation type	Operating tool Push-in
Nominal cross-section	1.5 mm ² / 16 AWG
Solid conductor	0.25 ... 1.5 mm ² / 22 ... 16 AWG
Solid conductor; push-in termination	0.75 ... 1.5 mm ² / 20 ... 16 AWG
Stranded conductor	0.25 ... 1 mm ² / 22 ... 18 AWG
Fine-stranded conductor	0.25 ... 1.5 mm ² / 22 ... 16 AWG
Fine-stranded conductor; with insulated ferrule	0.25 ... 0.75 mm ² / 22 ... 20 AWG
Fine-stranded conductor; with uninsulated ferrule	0.25 ... 0.75 mm ² / 22 ... 20 AWG
Fine-stranded conductor; with ferrule; push-in termination	0.75 mm ² / 20 AWG
Strip length	9 mm / 0.35 inches
Pole number	3
Connectable sheathed cable diameter	4.5 ... 10 mm
Conductor entry direction to mating direction	0°
Strip length (outer insulation)	40 mm

Physical data

Pin spacing	4.4 mm / 0.173 inches
Width	17.9 mm / 0.705 inches
Height	14 mm / 0.551 inches
Depth	63.6 mm / 2.504 inches

Mechanical data

Use	General mains applications
Coding	A
Variable coding	No
Marking	L N
Potential marking	L N
Mating force of a plug-in connection	approx. 20 ... 70 N (depending on pole number)
Retention force of a plug-in connection	Locked: > 80 N
Unmating force of a plug-in connection	Unlocked: approx. 20 ... 70 N (depending on pole number)
Number of mating cycles	200, without resistive load
Protection type	IP40

Plug-in connection

Contact type (pluggable connector)	Female connector/socket
Connector (connection type)	for conductor
Mismating protection	Yes
Note on mismating protection	All WINSTA® components are 100% protected against mismating when: a.) plugging different numbers of poles b.) plugging while rotated 180 c.) plugging while laterally staggered d.) plugging one pole
Locking lever	Can be retrofitted
Locking of plug-in connection	Locking lever
Note on locking system	All connectors for mounted installations (snap-in versions for lighting fixtures or devices, all types of PCB and distribution connectors) are factory-equipped with locking levers to ensure plugs and sockets are securely locked. Additional locking levers are only required for flying leads (plug/socket).
Strain relief	Strain relief housing

Material data

Note (material data)	Information on material specifications can be found here
Color	black
Cover color	gray
Material group	I
Insulation material (main housing)	Polyamide (PA66)
Flammability class per UL94	V0
Clamping spring material	Chrome-nickel spring steel (CrNi)
Contact material	Copper or copper alloy; surface-treated
Contact Plating	Tin
Fire load	0.286 MJ
Connector color	black
Strain relief color	black
Weight	7.2 g

Environmental requirements

Processing temperature	-5 ... +40 °C
Continuous operating temperature	-35 ... +85 °C
Note on continuous operating temperature	Insulating parts for temperatures ≤ 105 °C

Commercial data

Product Group	20 (Winsta)
eCl@ss 10.0	27-44-06-05
eCl@ss 9.0	27-44-06-05
ETIM 8.0	EC002560
ETIM 7.0	EC002560
PU (SPU)	50 pcs
Packaging type	Box
Country of origin	DE
GTIN	4045454232856
Customs tariff number	85366990990

Environmental Product Compliance

RoHS Compliance Status	Compliant, No Exemption
------------------------	-------------------------

Approvals / Certificates

General approvals



Approval	Standard	Certificate Name
CCA DEKRA Certification B.V.	EN 61535	71-123231
CCA DEKRA Certification B.V.	IEC 61535	NL-85020
cURus Underwriters Laboratories Inc.	UL 1977	E45171

Declarations of conformity and manufacturer's declarations

Approval	Standard	Certificate Name
EU-Declaration of Confor- mity WAGO GmbH & Co. KG	-	-
UK-Declaration of Confor- mity WAGO GmbH & Co. KG	-	-

Approvals for marine applications



Approval	Standard	Certificate Name
ABS American Bureau of Ship- ping	Steel Vessel Rules	19-HG1869855-PDA
DNV GL Det Norske Veritas, Ger- manischer Lloyd	-	TAE00001Z6
LR Lloyds Register	EN 61535	08/20047 (E2)

Downloads

Environmental Product Compliance

Compliance Search			
Environmental Product Compliance 890-103			↓

Documentation

Bid Text			
890-103	19.02.2019	xml 3.03 KB	↓
890-103	08.06.2015	doc 23.00 KB	↓

CAD/CAE-Data

CAD data	
2D/3D Models 890-103	↓

CAE data	
EPLAN Data Portal 890-103	↓
WSCAD Universe 890-103	↓
ZUKEN Portal 890-103	↓

1 Compatible Products

1.1 System counterpart

1.1.1 Cable assembly



Item No.: 891-8993/205-101
pre-assembled connecting cable; Eca; Plug/open-ended; 3-pole; Cod. A; 1 m; 1,00 mm²; black

Item No.: 891-8993/005-101
pre-assembled interconnecting cable; Eca; Socket/plug; 3-pole; Cod. A; 1 m; 1,00 mm²; black

1.1.2 Distribution connector



Item No.: 890-634
h-distribution connector; 3-pole; Cod. A; 1 input; 2 outputs; outputs on one side; 2 locking levers; black

Item No.: 890-636
h-distribution connector; 3-pole; Cod. A; 1 input; 2 outputs; outputs on one side; 3 locking levers; for flying leads; black

Item No.: 890-606
T-distribution connector; 3-pole; Cod. A; 1 input; 2 outputs; 2 locking levers; black

Item No.: 890-615
T-distribution connector; 3-pole; Cod. A; 1 input; 2 outputs; 3 locking levers; for flying leads; black

1.1.3 Male connector/plug



Item No.: 890-813/011-000

Plug for PCBs; angled; 3-pole; Cod. A; black

Item No.: 890-813

Plug for PCBs; straight; 3-pole; Cod. A; black

Item No.: 890-213

Plug; 3-pole; Cod. A; 1,50 mm²; black

Item No.: 890-113

Plug; with strain relief housing; 3-pole; 1,50 mm²; black



Item No.: 890-713

Snap-in plug; 3-pole; Cod. A; 1,50 mm²; black

1.2 Required Accessories

1.2.1 Locking system

1.2.1.1 Locking system



Item No.: 890-111

Locking lever; for flying leads; for tool operation; black

Item No.: 890-131

Locking lever; for flying leads; for tool operation; white

Item No.: 890-101

Locking lever; for manual operation; black

Item No.: 890-121

Locking lever; for manual operation; white

1.3 Optional Accessories

1.3.1 Cover

1.3.1.1 Cover



Item No.: 897-2001

Protective cap; Type1; for sockets and plugs; PVC; red

1.3.2 Installation

1.3.2.1 Mounting accessories



Item No.: 890-310

Mounting carrier; 2- to 5-pole; for flying leads; black

Item No.: 890-311

Mounting carrier; 2- to 5-pole; for flying leads; white

1.3.3 Shield termination

1.3.3.1 Shield termination



Item No.: 890-523

Shield connecting plate; 3-pole; for sockets and plugs; silver-colored

1.3.4 Tool

1.3.4.1 Operating tool



Item No.: 890-383

Operating tool; 3-way; green



Item No.: 210-719

Operating tool; Blade: 2.5 x 0.4 mm; with a partially insulated shaft

Installation Notes

Conductor termination

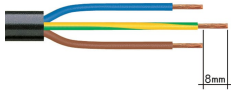

1. Strip length, outer insulation = 30 mm (2-pole), 37 mm (3-pole), 45 mm (4- and 5-pole)
2. Strip length = 9 mm
3. Extended ground conductor = 8 mm

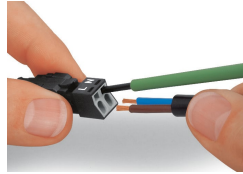

To terminate fine-stranded conductors, open the clamping unit via screwdriver – 2.5 mm blade width – and insert a stripped conductor until it hits the backstop. Terminate solid conductors by simply pushing them in.

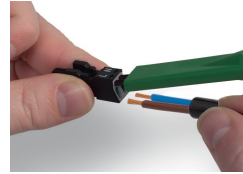

To terminate fine-stranded conductors, open clamping units via operating tool (890-382) and insert stripped conductors until they hit backstop. Terminate solid conductors by simply pushing them in.

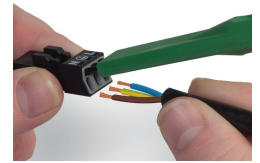

To terminate fine-stranded conductors, open clamping units via operating tool (890-383) and insert stripped conductors until they hit backstop. Terminate solid conductors by simply pushing them in.

Installation

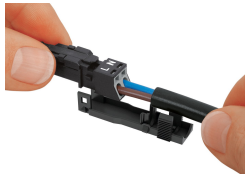

Latch the wired connector into the base of the strain relief housing.



Push down strain relief clamp by hand.



Push down strain relief clamp with 2.5 mm screwdriver alternately on both sides.

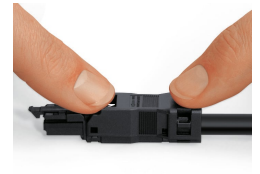

Latch the top of the strain relief housing.



The printed marking of the connector is clearly visible in the openings of the strain relief housing.

Shield termination



Connector with shield termination



Apply the shield to the sheathed cable.
Strip length, outer insulation = 30 mm
Shield length = 8 mm



Push the shield connecting plate into the connector until fully inserted.



First insert the wired connector into strain relief housing, then snap clamp and cover.