

CKTS	A	B	C
02	6.65/.262	NA	NA
04	9.65/.380	3.00/.118	NA
06	12.65/.498	6.00/.236	NA
08	15.65/.616	9.00/.354	4.70/.185
10	18.65/.734	12.00/.472	7.70/.303
12	21.65/.852	15.00/.591	10.70/.421
14	24.65/.970	18.00/.709	13.70/.539
16	27.65/1.088	21.00/.827	16.70/.539
18	30.65/1.206	24.00/.945	19.70/.776
20	33.65/1.325	27.00/1.063	22.70/.894
22	36.65/1.443	30.00/1.181	25.70/1.012
24	39.65/1.561	33.00/1.299	28.70/1.130

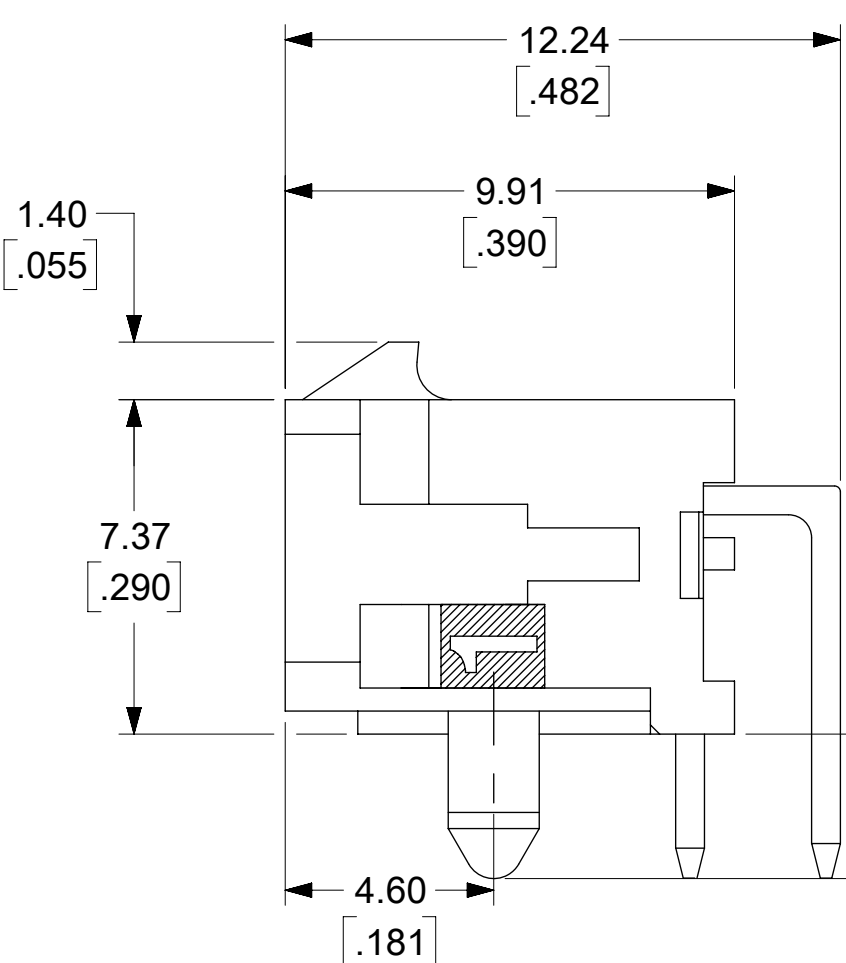

PCB LAYOUT: COMPONENT SIDE  
RECOMMEND PCB THICKNESS: 1.57/.062

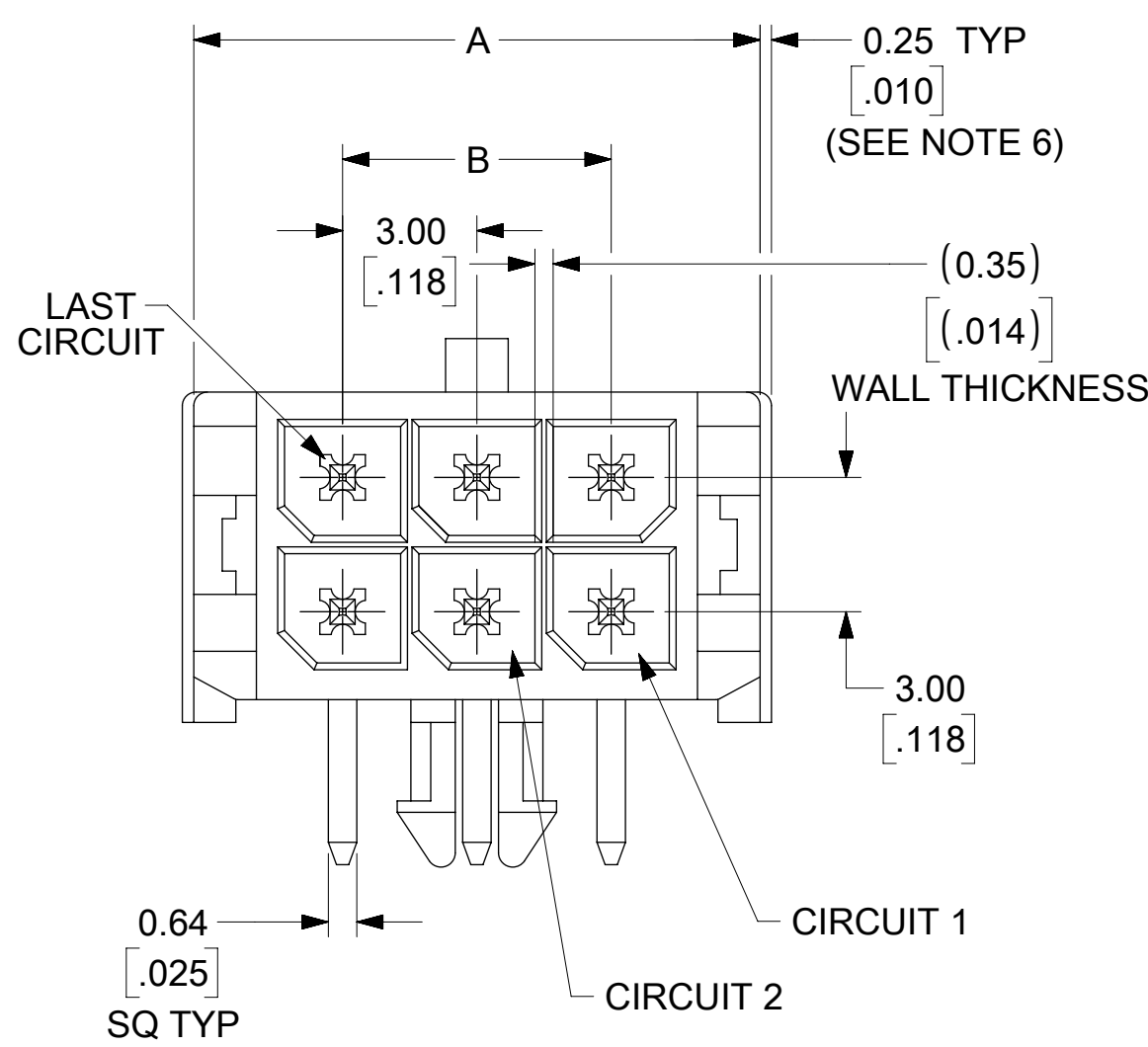
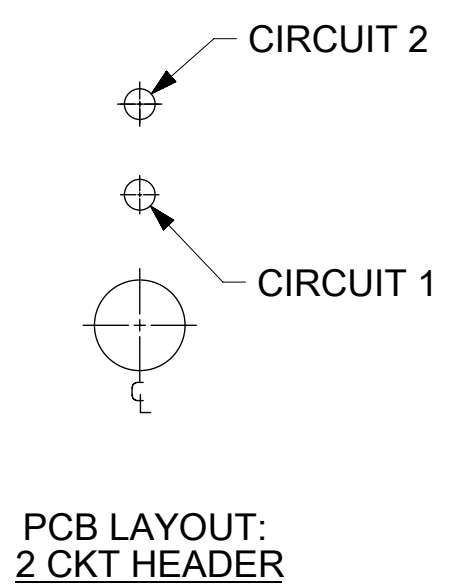
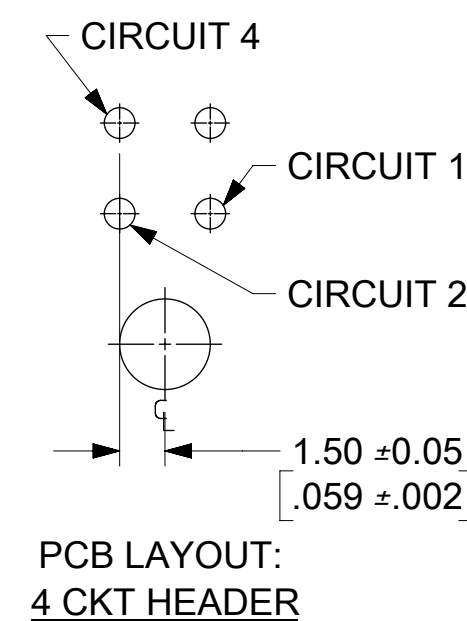
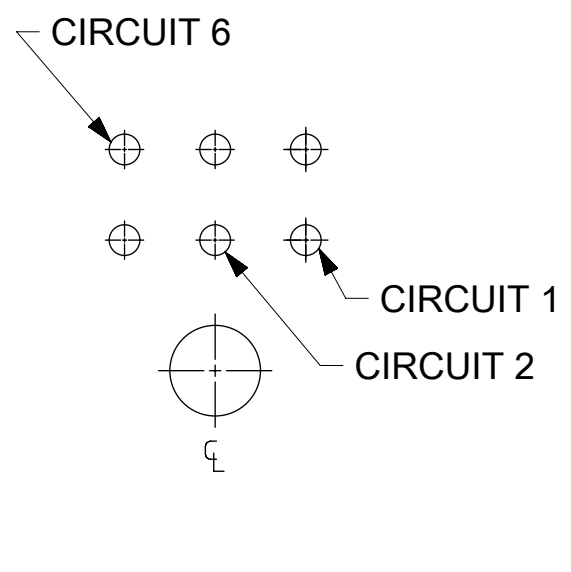

CIRCUIT "1" IDENTIFIED ON THIS SURFACE  
(APPROX. LOCATION SHOWN FOR REF.)

- NOTES:**
- HOUSING MATERIAL: GLASS FILLED LIQUID CRYSTAL POLYMER, UL94V-0, COLOR: BLACK  
TERMINAL MATERIAL: BRASS ALLOY
  - FINISH: A = 0.00152/(.000060) MIN. REFLOWED MATTE TIN OVER 0.00127/(.000050) MIN. NICKEL PLATE. (FINISH IS BRIGHT IN APPEARANCE. THICKNESS AS APPLIED PRIOR TO REFLOW)  
B = 0.00038/(.000015) MIN. SELECT GOLD IN CONTACT AREA; 0.00254/(.000100) MIN. SELECT MATTE TIN ON SOLDER TAILS; BOTH OVER 0.00127/(.000050) MIN. NICKEL PLATE.  
C = 0.00076/(.000030) MIN. SELECT GOLD IN CONTACT AREA; 0.00254/(.000100) MIN. SELECT MATTE TIN ON SOLDER TAILS; BOTH OVER 0.00127/(.000050) MIN. NICKEL PLATE.  
D = 0.00254/(.000100) MIN. MATTE TIN OVER 0.00127/(.000050) MIN. NICKEL OVERALL
  - PRODUCT SPECIFICATION: PS-43045
  - TRAY PACKAGED : SEE MOLEX DRAWING PK-70873-0313
  - MATES WITH MICRO FIT (3.0) RECEPTACLE SERIES 43025
  - CIRCUIT SIZES 2-6: "D" IS 6.74/.265 FOR 0.25/.010 STEP.  
CIRCUIT SIZES 8-24: "D" IS 1.60/.063 FOR 0.25/.010 STEP.
  - TO AVOID INTERFERENCE BETWEEN RECEPTACLE AND PCB, HEADER MUST BE PLACED WITHIN 10.16/(.400) MAX. FROM EDGE OF PCB, AS SHOWN IN LOCATION DETAIL.
  - THIS PART CONFORMS TO CLASS B REQUIREMENTS OF PRODUCT SPECIFICATION PS-45499-002.

CKTS	FINISH A	FINISH B	FINISH C	FINISH D
	MATERIAL NO:	MATERIAL NO:	MATERIAL NO:	MATERIAL NO:
02	43045-0200	43045-0201	43045-0202	43045-0310
04	43045-0400	43045-0401	43045-0402	43045-0510
06	43045-0600	43045-0601	43045-0602	43045-0710
08	43045-0800	43045-0801	43045-0802	43045-0910
10	43045-1000	43045-1001	43045-1002	43045-1110
12	43045-1200	43045-1201	43045-1202	43045-1310
14	43045-1400	43045-1401	43045-1402	43045-1510
16	43045-1600	43045-1601	43045-1602	43045-1710
18	43045-1800	43045-1801	43045-1802	43045-1910
20	43045-2000	43045-2001	43045-2002	43045-2110
22	43045-2200	43045-2201	43045-2202	43045-2310
24	43045-2400	43045-2401	43045-2402	43045-2510

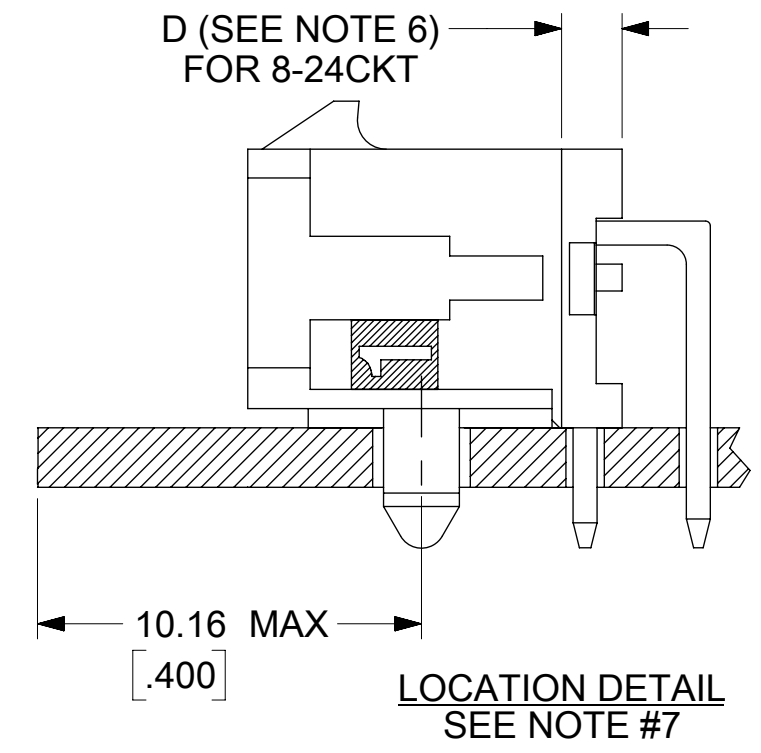

THIS DRAWING CONTAINS INFORMATION THAT IS PROPRIETARY TO MOLEX ELECTRONIC TECHNOLOGIES, LLC AND SHOULD NOT BE USED WITHOUT WRITTEN PERMISSION

DIMENSION UNITS	SCALE	CURRENT REV DESC: MIGRATED TO ECTR	
mm	1:1		
GENERAL TOLERANCES (UNLESS SPECIFIED)			
	MM	INCH	
4 PLACES	±	±	
3 PLACES	±	± 0.01	
2 PLACES	± 0.25	± 0.014	
1 PLACE	± 0.36	±	
0 PLACES	±	±	
ANGULAR TOL	± 0.5 °		
DRAFT WHERE APPLICABLE MUST REMAIN WITHIN DIMENSIONS		THIRD ANGLE PROJECTION	DRAWING SERIES
			C-SIZE 43045

EC NO: 788345	2018/03/12	 MICRO-FIT (3.0) DUAL ROW RIGHT ANGLE THRU HOLE HEADER ASS'Y PRODUCT CUSTOMER DRAWING	
DRWN: RLALSANGI	2024/06/05		
CHK'D: XQZHANG	2024/06/05		
APPR: XQZHANG	2024/06/05	DOCUMENT NUMBER	
INITIAL REVISION:		DOC TYPE	DOC PART
DRWN: SAMIEC	2000/03/15	PSD	001
APPR: FSMITH	2016/08/23	CUSTOMER	H
MATERIAL NUMBER		SHEET NUMBER	
SEE CHART	GENERAL MARKET	1 OF 2	

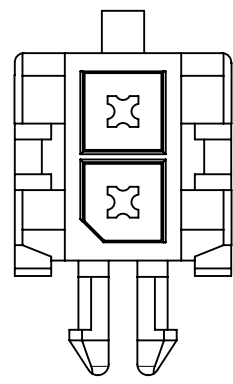

2 CKT

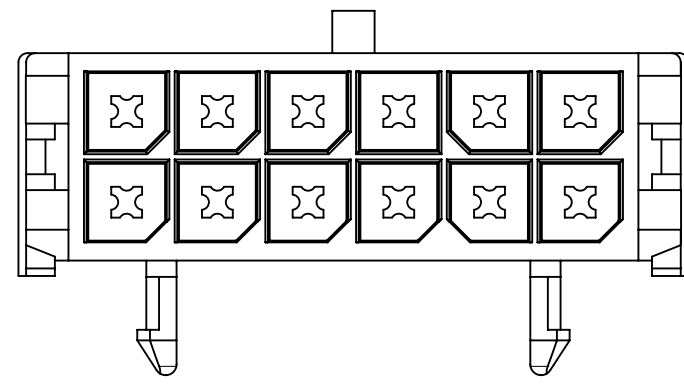

12 CKT

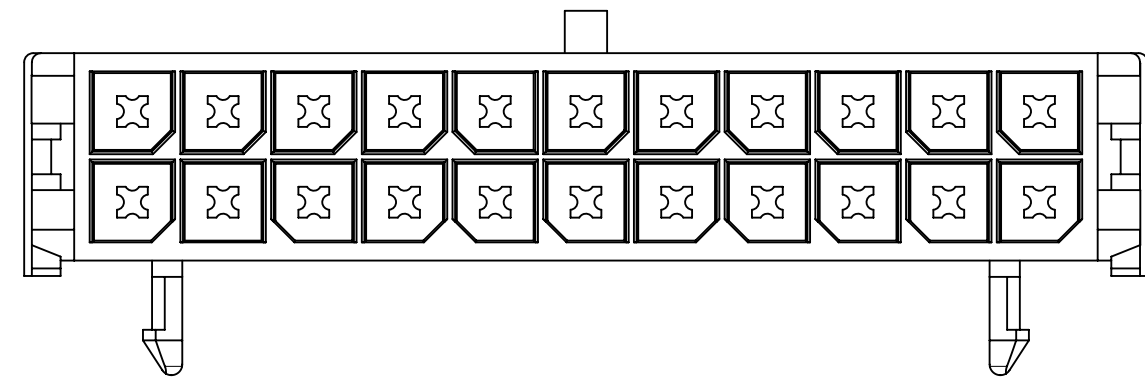

22 CKT

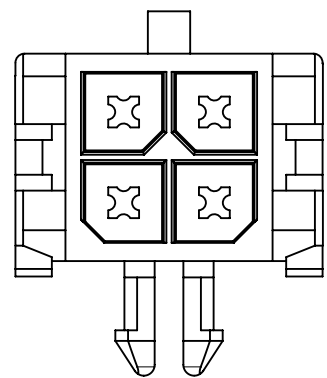

4 CKT

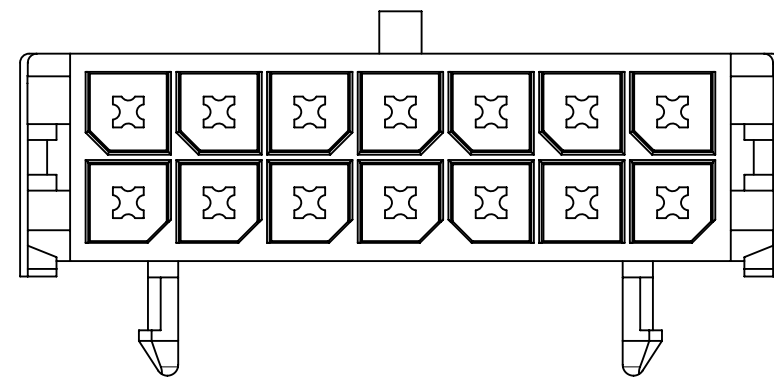

14 CKT

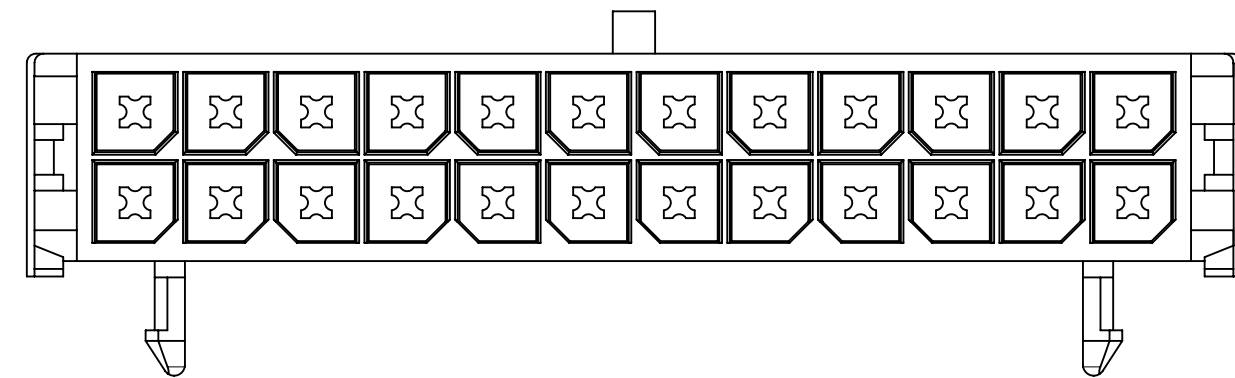

24 CKT

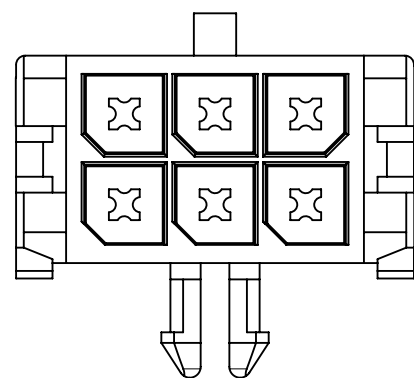

6 CKT

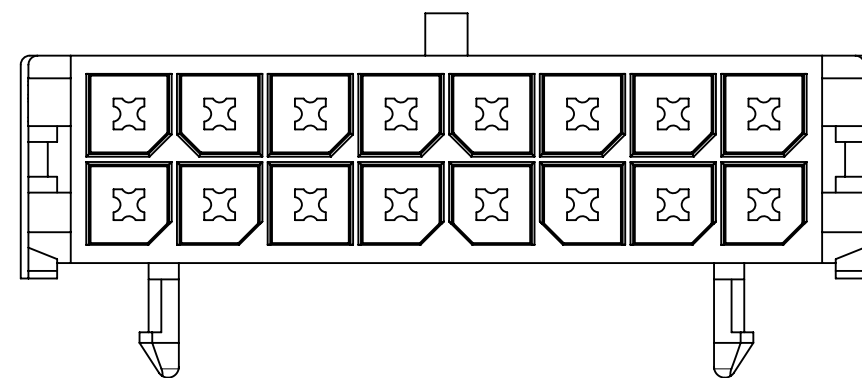

16 CKT

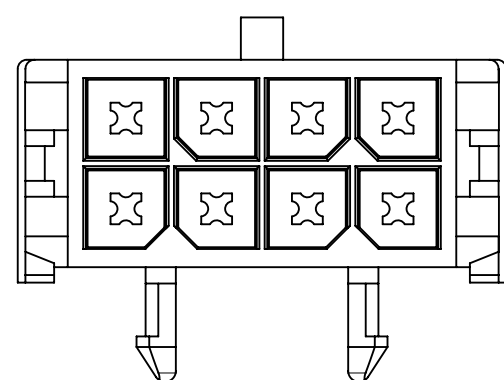

8 CKT

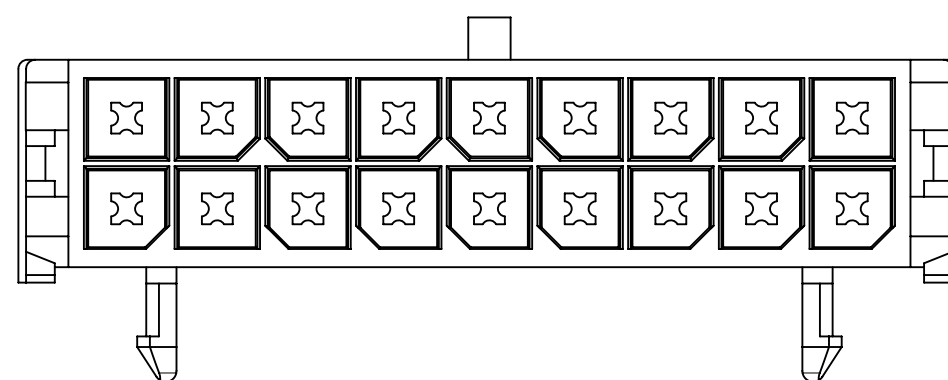

18 CKT

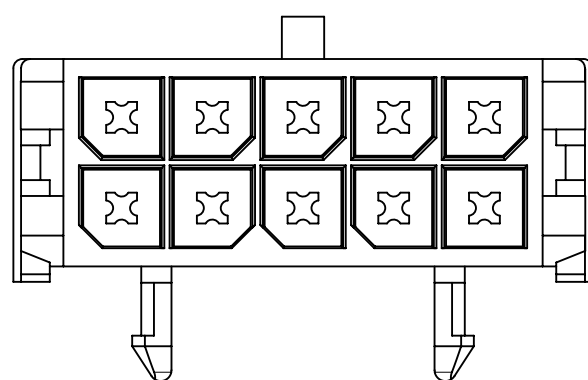

10 CKT

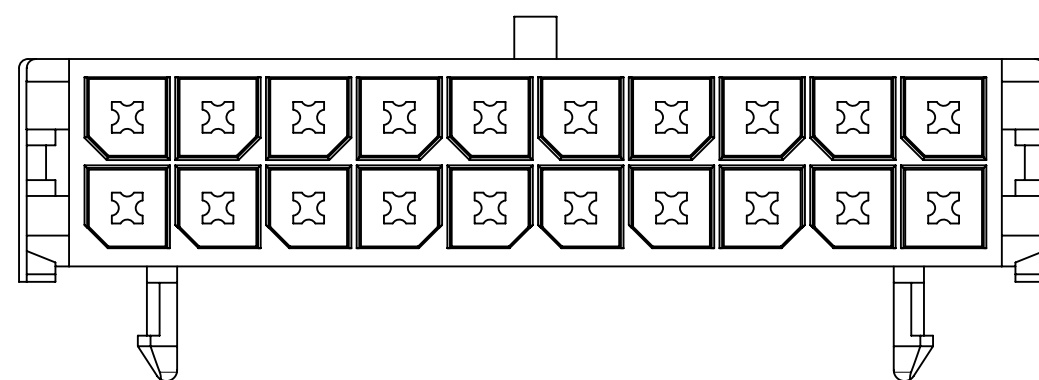

20 CKT

THIS DRAWING CONTAINS INFORMATION THAT IS PROPRIETARY TO MOLEX ELECTRONIC TECHNOLOGIES, LLC AND SHOULD NOT BE USED WITHOUT WRITTEN PERMISSION									
DIMENSION UNITS		SCALE		CURRENT REV DESC: MIGRATED TO ECTR					
mm		2:1		<p><b>molex</b></p> <p>MICRO-FIT (3.0) DUAL ROW RIGHT ANGLE THRU HOLE HEADER ASS'Y</p> <p>PRODUCT CUSTOMER DRAWING</p> <p>DOCUMENT NUMBER: SD-43045-001   DOC TYPE: PSD   DOC PART: 001   REVISION: H</p> <p>MATERIAL NUMBER: SEE CHART   CUSTOMER: GENERAL MARKET   SHEET NUMBER: 2 OF 2</p>					
GENERAL TOLERANCES (UNLESS SPECIFIED)									
	MM	INCH							
4 PLACES	±	±							
3 PLACES	±	±	0.01						
2 PLACES	±	0.25	± 0.014						
1 PLACE	±	0.36	±						
0 PLACES	±	±							
ANGULAR TOL		± 0.5 °		INITIAL REVISION:		2000/03/15		2016/08/23	
DRAFT WHERE APPLICABLE MUST REMAIN WITHIN DIMENSIONS		THIRD ANGLE PROJECTION		DRAWING		SERIES		MATERIAL NUMBER	
				C-SIZE		43045		SEE CHART	