

AMY-70-W

~36° wide beam

SPECIFICATION:

Dimensions	Ø 69.9
Height	13 mm
Fastening	socket
ROHS compliant	yes ⓘ

MATERIALS:

Component	Type	Material	Colour	Finish	Length (mm)
AMY-70-W	Single lens	PMMA	clear		
AMY-70-HLD2-C	Holder C	PC	black		
AMY-70-HLD2-B	Holder B	PC	black		
AMY-70-HLD2-C-WHT	Holder C	PC	white		
AMY-70-HLD2-B-WHT	Holder B	PC	white		
AMY-70-HLD2-B50	Holder B	PC	black		
AMY-70-HLD2-B50-WHT	Holder B	PC	white		



ORDERING INFORMATION:

Component	Qty in box	MOQ	MPQ	Box weight (kg)
C17778_AMY-70-W	285	285	15	9.0
Assembly				
CP19653_AMY-70-W-B50-WHT	210	210	15	8.6
CP19645_AMY-70-W-B50	210	210	15	8.5
CP19117_AMY-70-W-B2-WHT	210	210	15	8.5
CP19109_AMY-70-W-C2-WHT	210	210	15	8.2
CP19092_AMY-70-W-B2	210	210	15	8.5
CP19039_AMY-70-W-C2	210	210	15	8.2

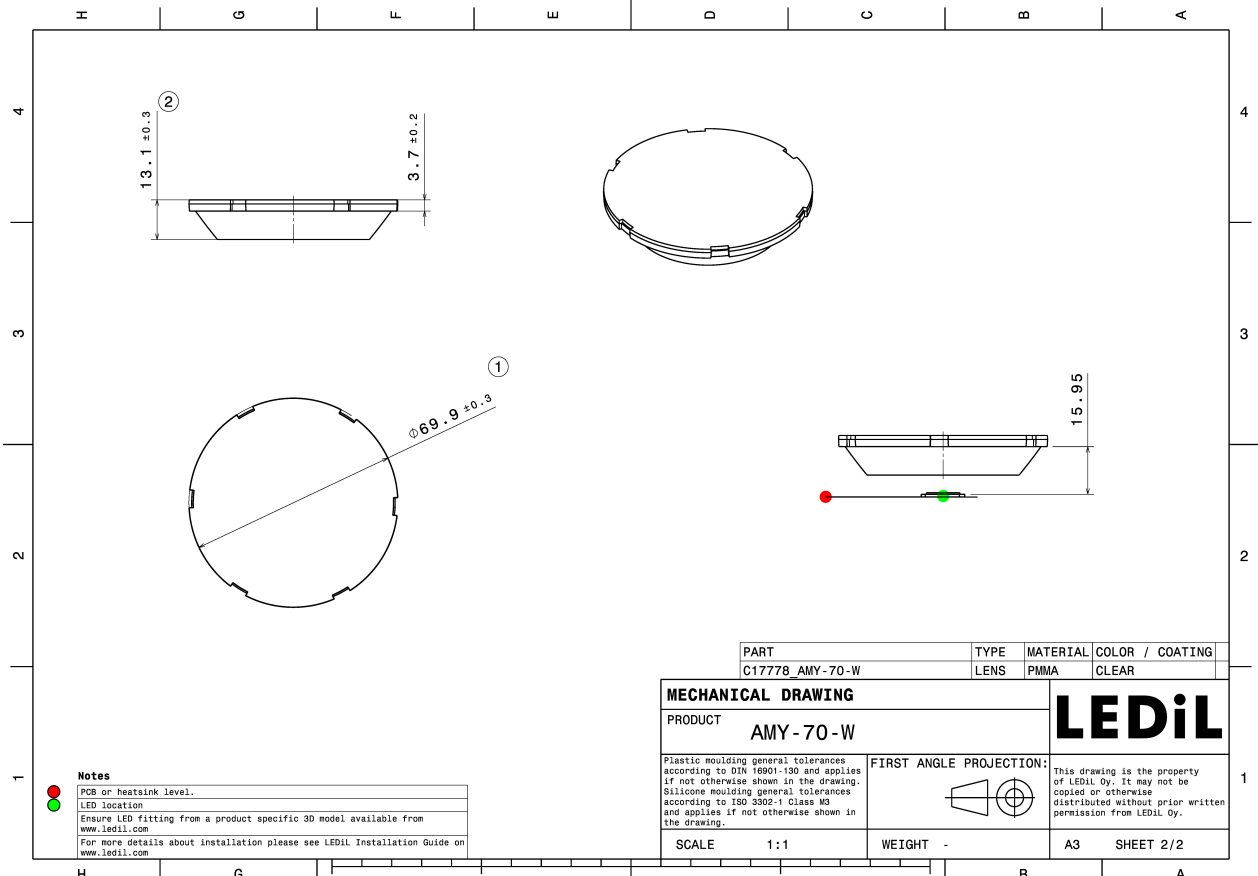
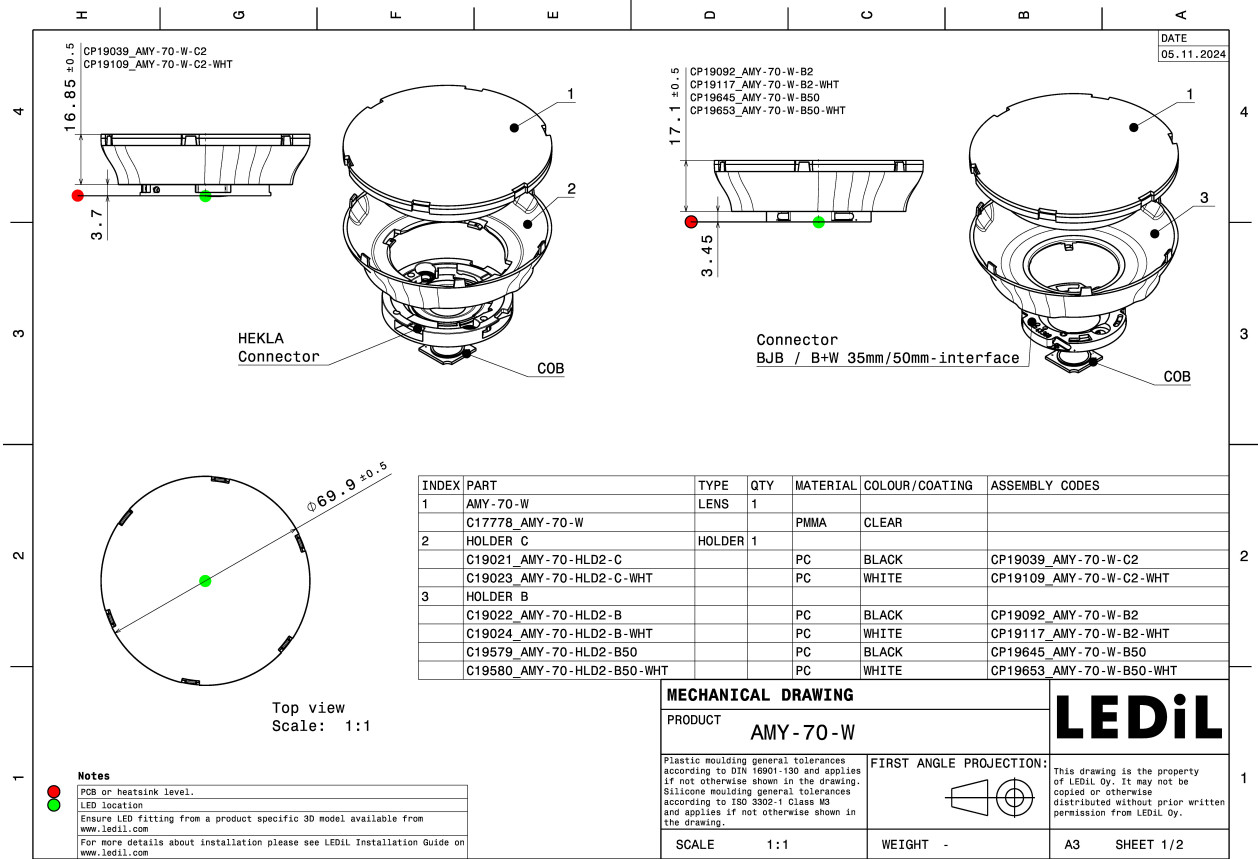

See also our general installation guide: www.ledil.com/installation_guide

OPTICAL RESULTS (MEASURED):



LED V10 Gen 8-9
Ordering code CP19039_AMY-70-W-C2
FWHM / FWTM 35.0° / 59.0°
Efficiency 90 %
LEDs/each optic 1
Light colour/type White
Required components:
 F15255_HEKLA-SOCKET-C

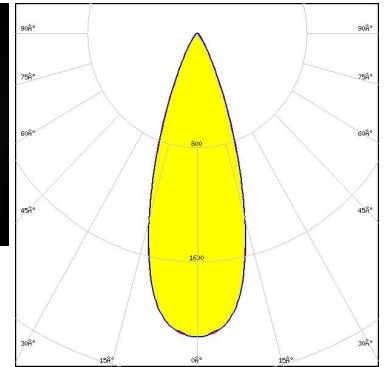

Light distribution files



LED V11 HD Gen 8
Ordering code CP19039_AMY-70-W-C2
FWHM / FWTM 36.0° / 60.0°
Efficiency 88 %
LEDs/each optic 1
Light colour/type White
Required components:
 Bender Wirth: 633d Hekla

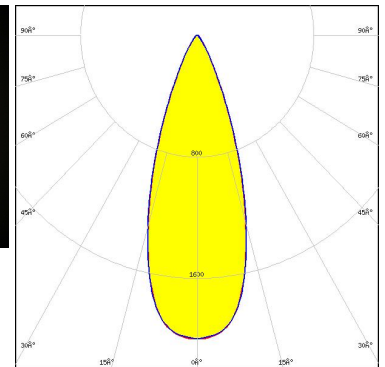
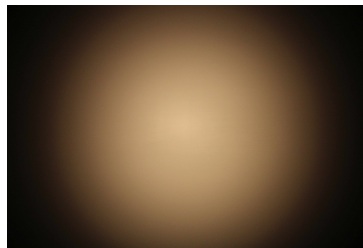

Light distribution files



LED V13 Gen 8-9
Ordering code CP19039_AMY-70-W-C2
FWHM / FWTM 38.0° / 66.0°
Efficiency 87 %
LEDs/each optic 1
Light colour/type White
Required components:
 F15859_HEKLA-SOCKET-I

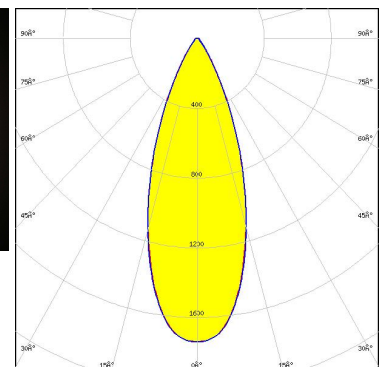
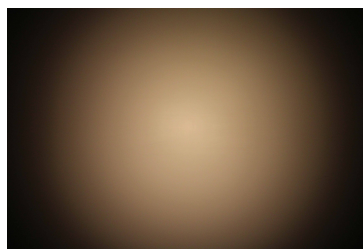

Light distribution files

OPTICAL RESULTS (MEASURED):



LED V8 Gen 8-9
Ordering code CP19039_AMY-70-W-C2
FWHM / FWTM 34.0° / 58.0°
Efficiency 91 %
LEDs/each optic 1
Light colour/type White
Required components:
 F15253_HEKLA-SOCKET-A

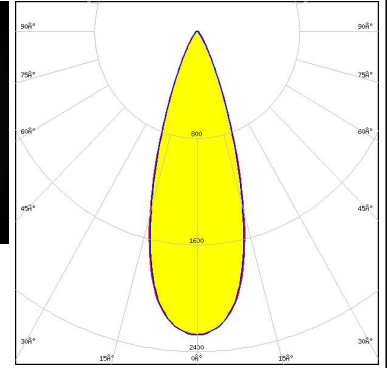

Light distribution files

CITIZEN

LED CLL02x/CLU02x (LES10)
Ordering code CP19039_AMY-70-W-C2
FWHM / FWTM 35.0° / 59.0°
Efficiency 88 %
LEDs/each optic 1
Light colour/type White
Required components:
 F17435_HEKLA-G2-C

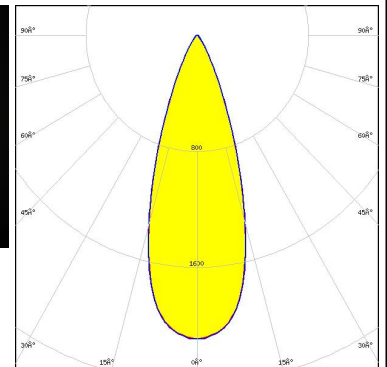
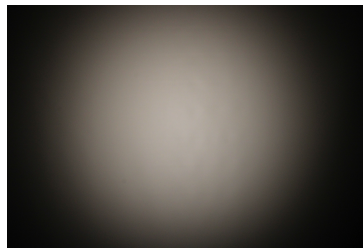

Light distribution files

CITIZEN

LED CLU700/701/702/703
Ordering code CP19092_AMY-70-W-B2
FWHM / FWTM 30.0° / 51.0°
Efficiency 91 %
LEDs/each optic 1
Light colour/type White
Required components:
 BJB: 47.360.1020

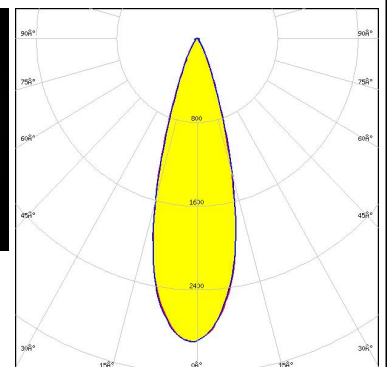
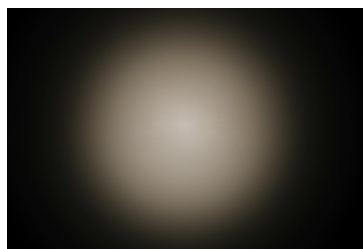

Light distribution files

OPTICAL RESULTS (MEASURED):

CITIZEN

LED CLU7S3
 Ordering code CP19092_AMY-70-W-B2
 FWHM / FWTM 31.0° / 53.0°
 Efficiency 92 %
 LEDs/each optic 1
 Light colour/type White
 Required components:
 Bender Wirth: 667a Bayonet35

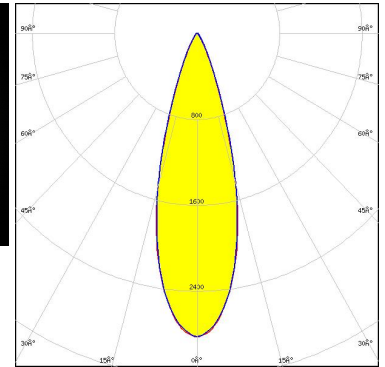

Light distribution files



LED CMU15xx
 Ordering code CP19039_AMY-70-W-C2
 FWHM / FWTM 38.0° / 66.0°
 Efficiency 86 %
 LEDs/each optic 1
 Light colour/type White
 Required components:
 F17438_HEKLA-G2-I

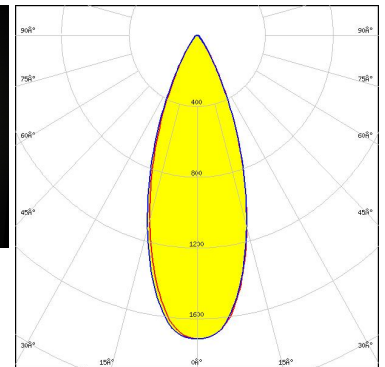
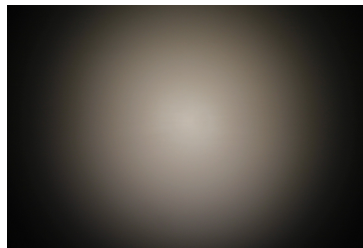

Light distribution files



LED LUXEON Fusion 12-up (20x24)
 Ordering code CP19039_AMY-70-W-C2
 FWHM / FWTM 33.0° / 58.0°
 Efficiency 82 %
 LEDs/each optic 1
 Light colour/type White
 Required components:
 C16142_HEKLA-SOCKET-K
 F18158_HEKLA-RZ-LENS
 Bender Wirth: 442 Typ L8

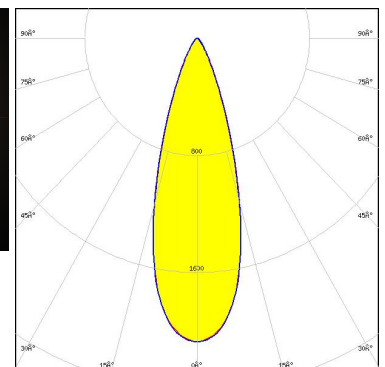
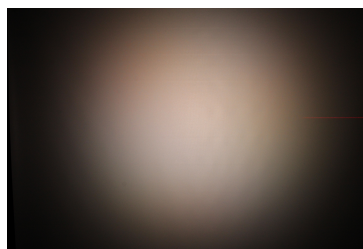

Light distribution files

OPTICAL RESULTS (MEASURED):



LED LUXEON Fusion 21-up (20x24)
Ordering code CP19039_AMY-70-W-C2
FWHM / FWTM 33.0° / 59.0°
Efficiency 81 %
LEDs/each optic 1
Light colour/type White
Required components:
 C16142_HEKLA-SOCKET-K
 F18158_HEKLA-RZ-LENS
 Bender Wirth: 442 Typ L8

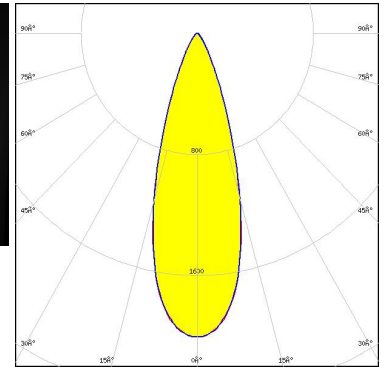
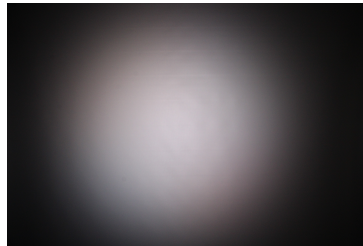

Light distribution files



LED LUXEON Fusion 27-up (20x24)
Ordering code CP19039_AMY-70-W-C2
FWHM / FWTM 36.0° / 63.0°
Efficiency 81 %
LEDs/each optic 1
Light colour/type White
Required components:
 C16142_HEKLA-SOCKET-K
 F18158_HEKLA-RZ-LENS
 Bender Wirth: 442 Typ L8

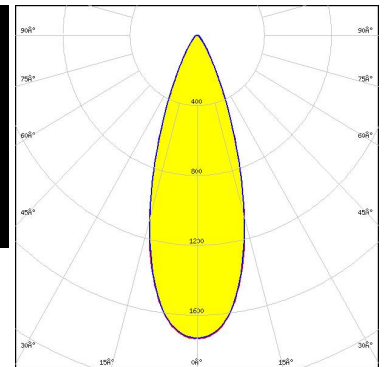

Light distribution files



LED CTM-14 (Tunable White) Gen2
Ordering code CP19039_AMY-70-W-C2
FWHM / FWTM 38.0° / 64.0°
Efficiency 87 %
LEDs/each optic 1
Light colour/type White
Required components:
 C16142_HEKLA-SOCKET-K
 Bender Wirth: 442 Typ L8

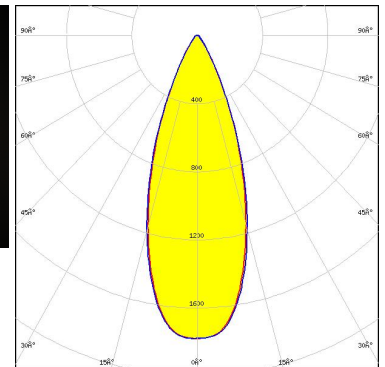
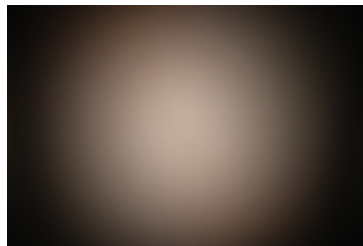

Light distribution files

OPTICAL RESULTS (MEASURED):

SAMSUNG

LED LC016D / LC019D / LC026D / LC033D
Ordering code CP19039_AMY-70-W-C2
FWHM / FWTM 38.0° / 66.0°
Efficiency 88 %
LEDs/each optic 1
Light colour/type White
Required components:
F15859_HEKLA-SOCKET-I

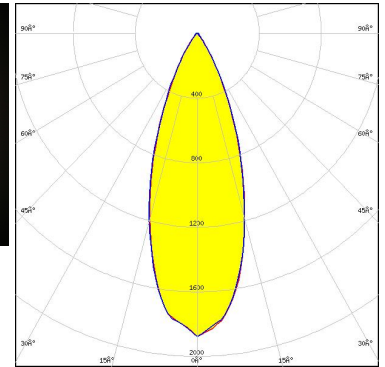
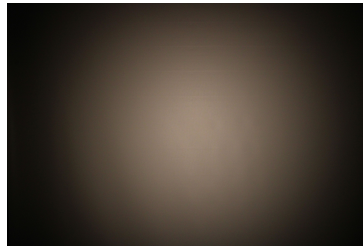

Light distribution files

SAMSUNG

LED LC016D / LC019D / LC026D / LC033D
Ordering code C17778_AMY-70-W
FWHM / FWTM 38.0° / 66.0°
Efficiency 88 %
LEDs/each optic 1
Light colour/type White
Required components:

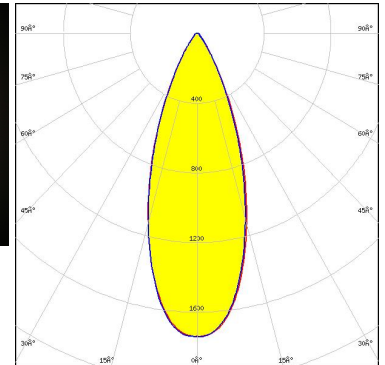
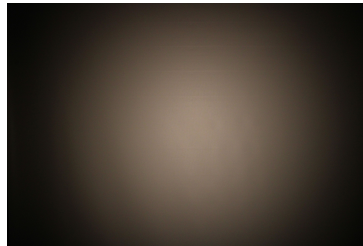

Light distribution files

OPTICAL RESULTS (SIMULATED):

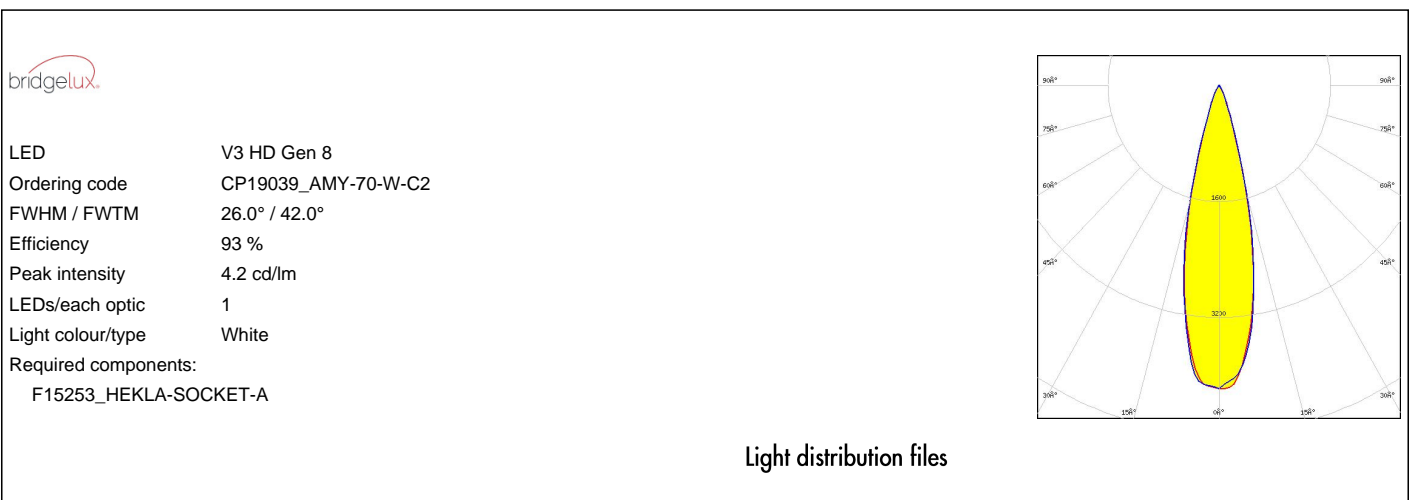
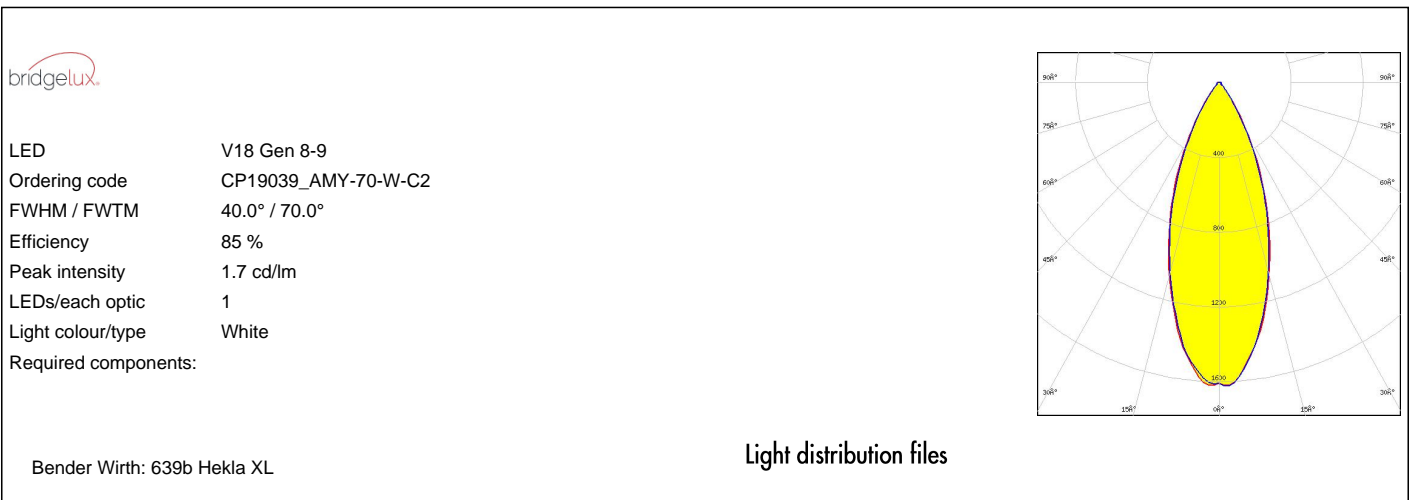
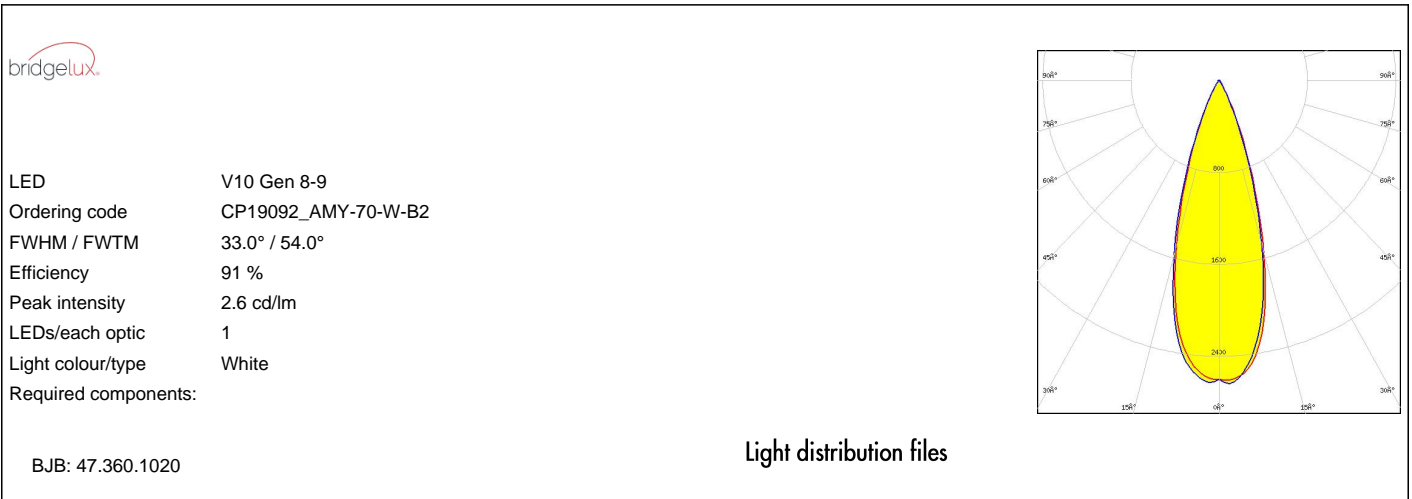

OPTICAL RESULTS (SIMULATED):



LED V4 HD Gen 8
Ordering code CP19039_AMY-70-W-C2
FWHM / FWTM 26.0° / 44.0°
Efficiency 93 %
Peak intensity 4 cd/lm
LEDs/each optic 1
Light colour/type White
Required components:
 F15253_HEKLA-SOCKET-A

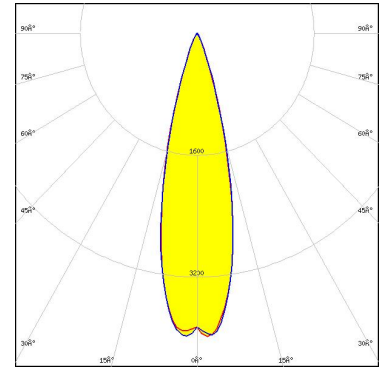

Light distribution files



LED V6 Gen 8-9
Ordering code CP19039_AMY-70-W-C2
FWHM / FWTM 29.0° / 46.0°
Efficiency 93 %
Peak intensity 3.5 cd/lm
LEDs/each optic 1
Light colour/type White
Required components:
 F15253_HEKLA-SOCKET-A

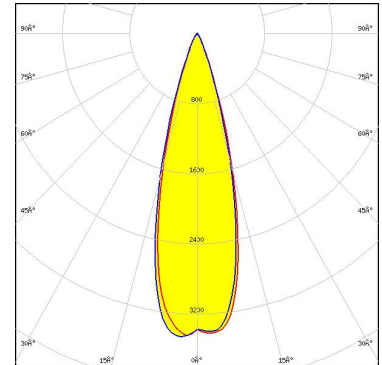

Light distribution files



LED V6 Gen 8-9
Ordering code CP19039_AMY-70-W-C2
FWHM / FWTM 29.0° / 46.0°
Efficiency 96 %
Peak intensity 3.5 cd/lm
LEDs/each optic 1
Light colour/type White
Required components:
 F15253_HEKLA-SOCKET-A

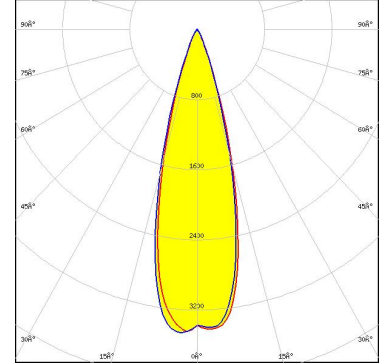

Light distribution files

OPTICAL RESULTS (SIMULATED):

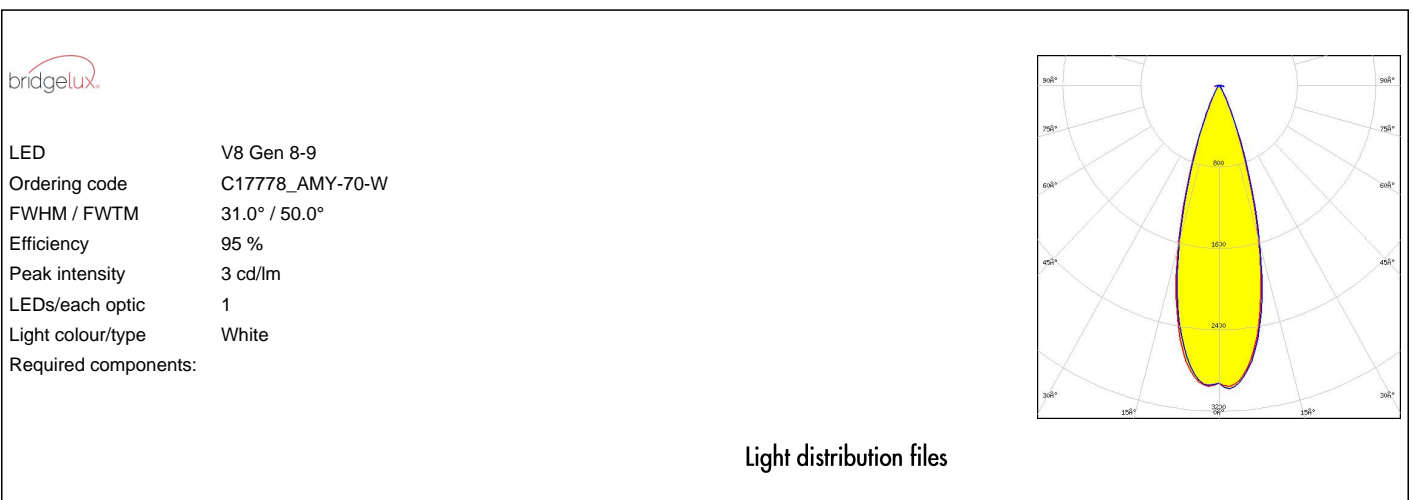
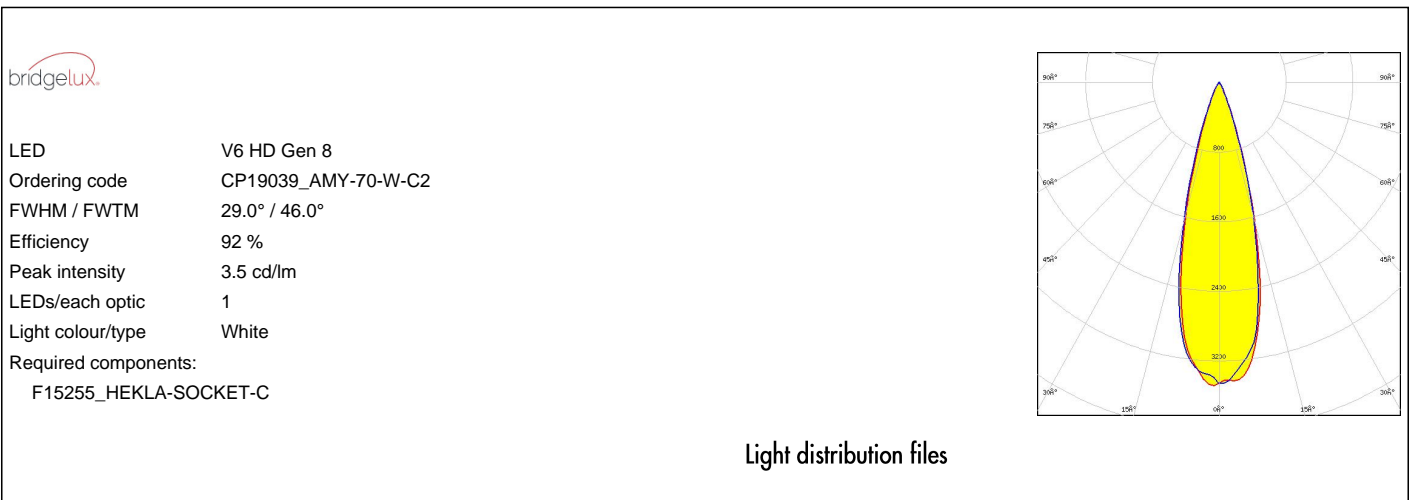
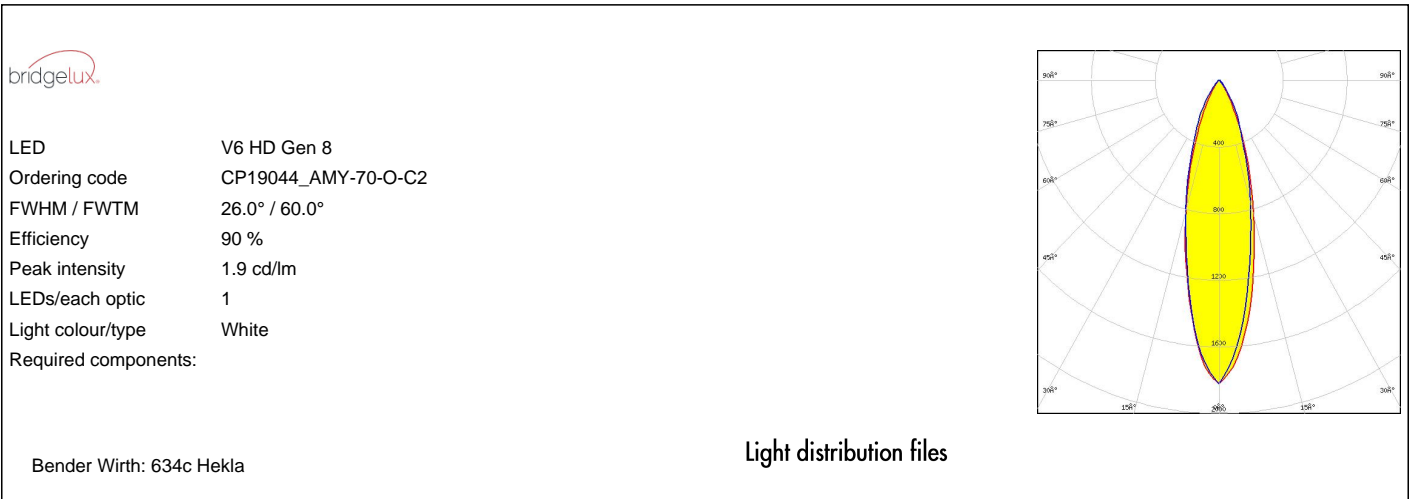

OPTICAL RESULTS (SIMULATED):



LED V8 Gen7
Ordering code CP19039_AMY-70-W-C2
FWHM / FWTM 30.0° / 50.0°
Efficiency 90 %
Peak intensity 3.1 cd/lm
LEDs/each optic 1
Light colour/type White
Required components:
 F15253_HEKLA-SOCKET-A

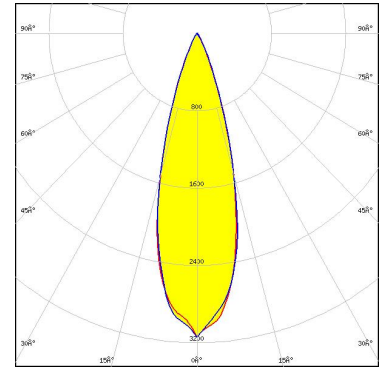

Light distribution files



LED V9 HD Gen 8
Ordering code CP19039_AMY-70-W-C2
FWHM / FWTM 30.0° / 48.0°
Efficiency 91 %
Peak intensity 3.3 cd/lm
LEDs/each optic 1
Light colour/type White
Required components:
 F15859_HEKLA-SOCKET-I

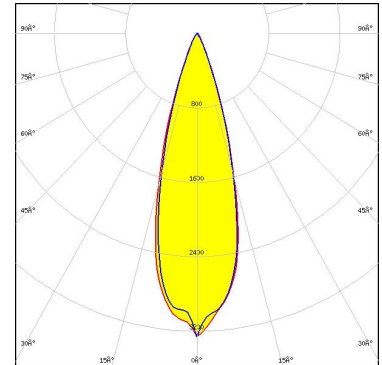

Light distribution files



LED VERO10
Ordering code CP19039_AMY-70-W-C2
FWHM / FWTM 31.0° / 52.0°
Efficiency 89 %
Peak intensity 2.9 cd/lm
LEDs/each optic 1
Light colour/type White
Required components:
 F15616_HEKLA-SOCKET-F

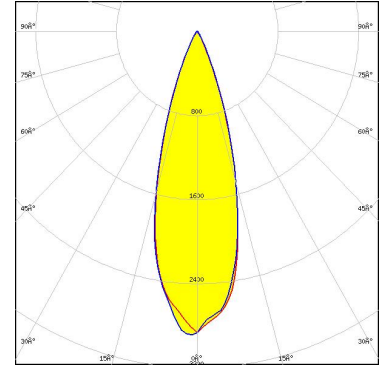

Light distribution files

OPTICAL RESULTS (SIMULATED):



LED VERO13
Ordering code CP19039_AMY-70-W-C2
FWHM / FWTM 34.0° / 56.0°
Efficiency 88 %
Peak intensity 2.4 cd/lm
LEDs/each optic 1
Light colour/type White
Required components:
 C16142_HEKLA-SOCKET-K

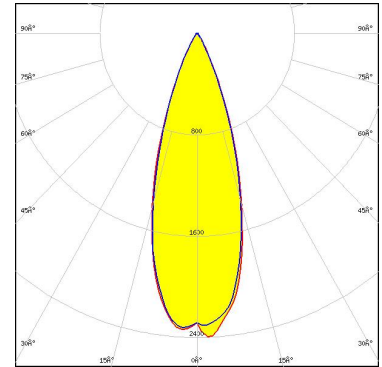

Light distribution files



LED VERO18
Ordering code CP19039_AMY-70-W-C2
FWHM / FWTM 39.0° / 71.0°
Efficiency 88 %
Peak intensity 1.7 cd/lm
LEDs/each optic 1
Light colour/type White
Required components:
 C16142_HEKLA-SOCKET-K

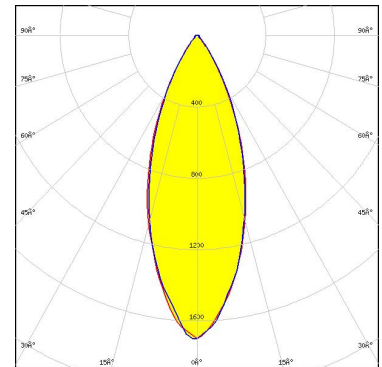

Light distribution files



LED Vesta DTW 13mm (21W)
Ordering code CP19039_AMY-70-W-C2
FWHM / FWTM 29.0° / 46.0°
Efficiency 92 %
Peak intensity 3.4 cd/lm
LEDs/each optic 1
Light colour/type White
Required components:

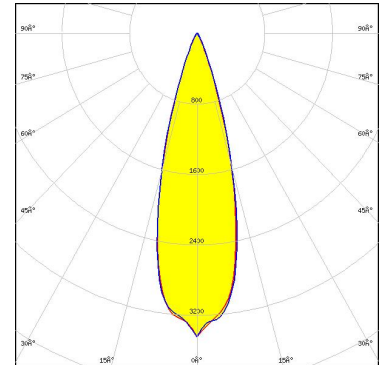

Bender Wirth: 632b Hekla XL

Light distribution files

OPTICAL RESULTS (SIMULATED):



LED Vesta DTW 15mm (33W)
Ordering code CP19039_AMY-70-W-C2
FWHM / FWTM 36.0° / 60.0°
Efficiency 90 %
Peak intensity 2.2 cd/lm
LEDs/each optic 1
Light colour/type White
Required components:

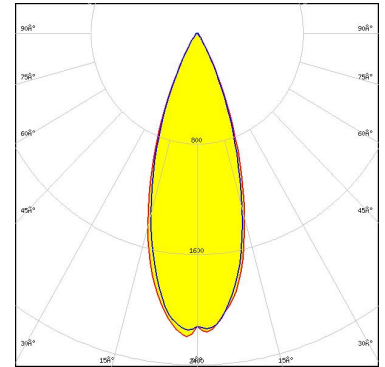

Bender Wirth: 632b Hekla XL

Light distribution files



LED Vesta DTW 6mm
Ordering code CP19039_AMY-70-W-C2
FWHM / FWTM 30.0° / 46.0°
Efficiency 92 %
Peak intensity 3.4 cd/lm
LEDs/each optic 1
Light colour/type White
Required components:

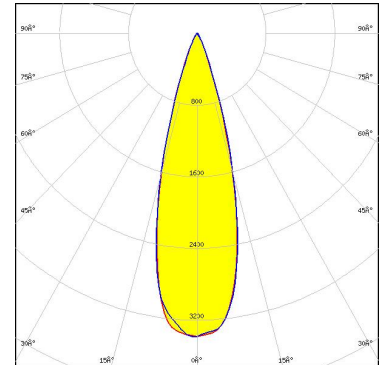

Bender Wirth: 652b Hekla

Light distribution files



LED Vesta DTW 9mm (4W/6W/12W)
Ordering code CP19039_AMY-70-W-C2
FWHM / FWTM 31.0° / 48.0°
Efficiency 92 %
Peak intensity 3.1 cd/lm
LEDs/each optic 1
Light colour/type White
Required components:

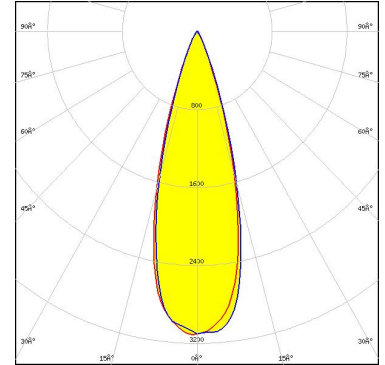

Bender Wirth: 652b Hekla

Light distribution files

OPTICAL RESULTS (SIMULATED):



LED Vesta SE 13mm TW
Ordering code CP19039_AMY-70-W-C2
FWHM / FWTM 33.0° / 57.0°
Efficiency 86 %
Peak intensity 2.3 cd/lm
LEDs/each optic 1
Light colour/type Tunable White
Required components:
C16142_HEKLA-SOCKET-K

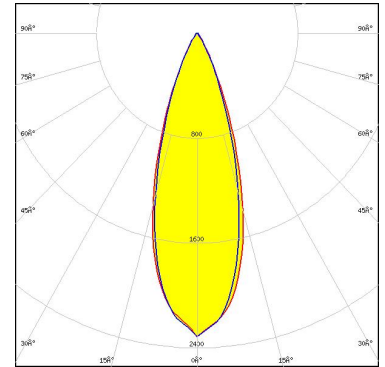

Light distribution files



LED Vesta TW 9mm (9W) DP
Ordering code CP19039_AMY-70-W-C2
FWHM / FWTM 35.0° / 54.0°
Efficiency 92 %
Peak intensity 2.7 cd/lm
LEDs/each optic 1
Light colour/type White
Required components:
C16142_HEKLA-SOCKET-K

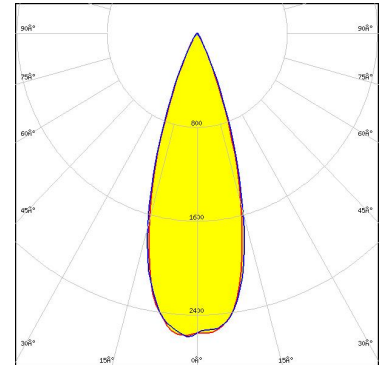

Light distribution files

Bender Wirth: 489 Typ L8

CITIZEN

LED CLL03x/CLU03x
Ordering code CP19039_AMY-70-W-C2
FWHM / FWTM 36.0° / 64.0°
Efficiency 87 %
Peak intensity 2 cd/lm
LEDs/each optic 1
Light colour/type White
Required components:
F15859_HEKLA-SOCKET-I

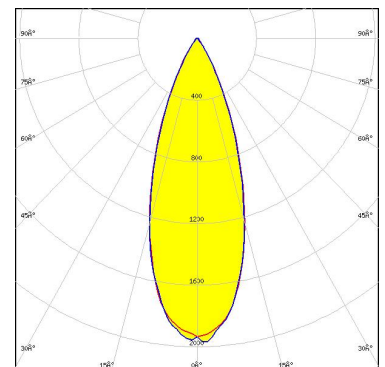

Light distribution files

OPTICAL RESULTS (SIMULATED):

CITIZEN

LED CLL04x/CLU04x
 Ordering code CP19039_AMY-70-W-C2
 FWHM / FWTM 39.0° / 75.0°
 Efficiency 79 %
 Peak intensity 1.4 cd/lm
 LEDs/each optic 1
 Light colour/type White
 Required components:

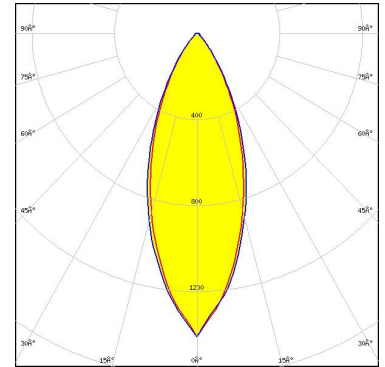

Bender Wirth: 631a Hekla XL

Light distribution files

CITIZEN

LED CLU03Q Type-F
 Ordering code CP19039_AMY-70-W-C2
 FWHM / FWTM 36.0° / 63.0 + 64.0°
 Efficiency 90 %
 Peak intensity 2.1 cd/lm
 LEDs/each optic 1
 Light colour/type White
 Required components:
 F17438_HEKLA-G2-I

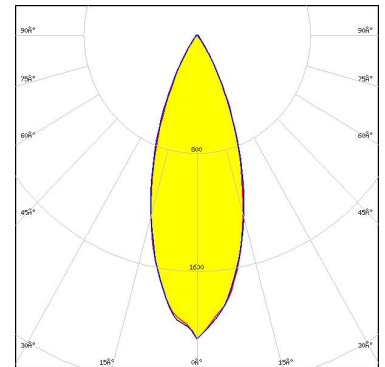

Light distribution files

CITIZEN

LED CLU700/701/702/703
 Ordering code CP19039_AMY-70-W-C2
 FWHM / FWTM 31.0° / 52.0°
 Efficiency 90 %
 Peak intensity 2.9 cd/lm
 LEDs/each optic 1
 Light colour/type White
 Required components:
 F15255_HEKLA-SOCKET-C

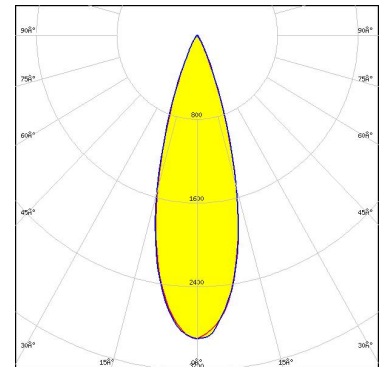

Light distribution files

OPTICAL RESULTS (SIMULATED):

CITIZEN

LED CLU700/701/702/703
Ordering code CP19039_AMY-70-W-C2
FWHM / FWTM 31.0° / 50.0°
Efficiency 91 %
Peak intensity 3 cd/lm
LEDs/each optic 1
Light colour/type White
Required components:
F15255_HEKLA-SOCKET-C

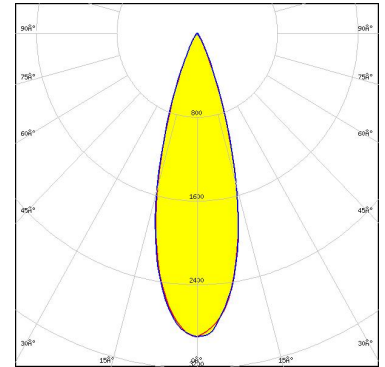

Light distribution files



LED CHA0410
Ordering code CP19039_AMY-70-W-C2
FWHM / FWTM 28.0° / 46.0°
Efficiency 92 %
Peak intensity 3.7 cd/lm
LEDs/each optic 1
Light colour/type White
Required components:
F17435_HEKLA-G2-C

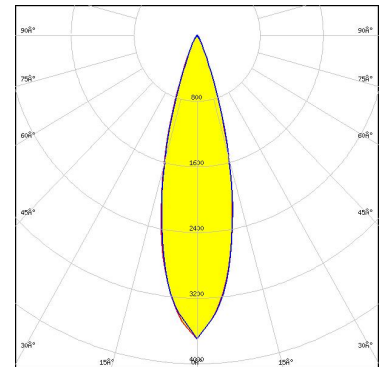

Light distribution files



LED CHA0612
Ordering code CP19039_AMY-70-W-C2
FWHM / FWTM 30.0° / 48.0°
Efficiency 92 %
Peak intensity 3.3 cd/lm
LEDs/each optic 1
Light colour/type White
Required components:
F17435_HEKLA-G2-C

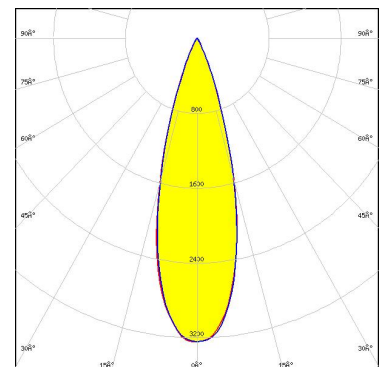

Light distribution files

OPTICAL RESULTS (SIMULATED):



LED CMA1825
Ordering code CP19039_AMY-70-W-C2
FWHM / FWTM 35.0° / 56.0°
Efficiency 89 %
Peak intensity 2.5 cd/lm
LEDs/each optic 1
Light colour/type White
Required components:
F15254_HEKLA-SOCKET-B

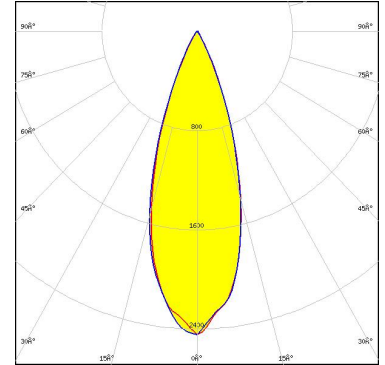

Light distribution files



LED CMT14xx
Ordering code C17778_AMY-70-W
FWHM / FWTM 32.0° / 50.0°
Efficiency 95 %
Peak intensity 2.9 cd/lm
LEDs/each optic 1
Light colour/type White
Required components:

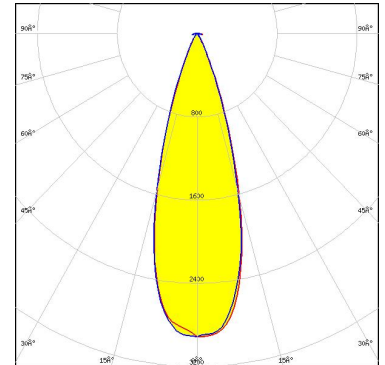

Light distribution files



LED CMT14xx
Ordering code CP19039_AMY-70-W-C2
FWHM / FWTM 31.0° / 50.0°
Efficiency 89 %
Peak intensity 2.9 cd/lm
LEDs/each optic 1
Light colour/type White
Required components:
F17435_HEKLA-G2-C

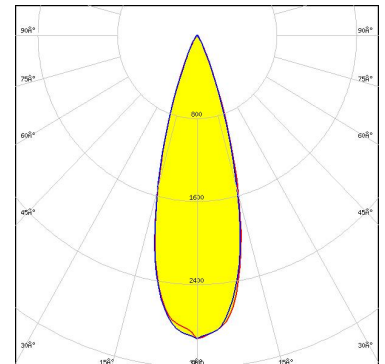

Light distribution files

OPTICAL RESULTS (SIMULATED):



LED CMU10xx
Ordering code CP19092_AMY-70-W-B2
FWHM / FWTM 32.0° / 54.0°
Efficiency 91 %
Peak intensity 2.8 cd/lm
LEDs/each optic 1
Light colour/type White
Required components:

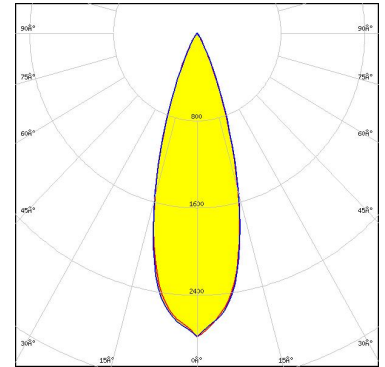

BJB: 47.360.1020

Light distribution files



LED CMU10xx
Ordering code CP19039_AMY-70-W-C2
FWHM / FWTM 32.0° / 50.0°
Efficiency 90 %
Peak intensity 2.9 cd/lm
LEDs/each optic 1
Light colour/type White
Required components:
 F17435_HEKLA-G2-C

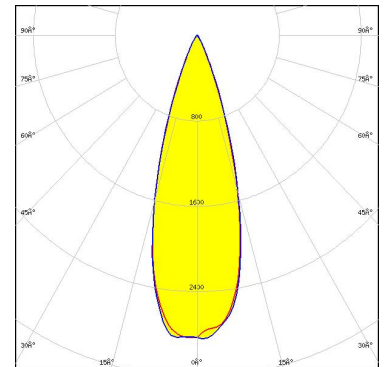

Light distribution files



LED CXA/B 15xx
Ordering code CP19039_AMY-70-W-C2
FWHM / FWTM 33.0° / 55.0°
Efficiency 88 %
Peak intensity 2.6 cd/lm
LEDs/each optic 1
Light colour/type White
Required components:
 F15256_HEKLA-SOCKET-D

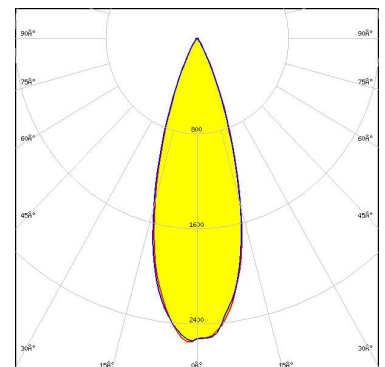

Light distribution files

OPTICAL RESULTS (SIMULATED):



LED LUXEON CX Plus CoB L08 (Gen2)
Ordering code CP19039_AMY-70-W-C2
FWHM / FWTM 36.0° / 60.0°
Efficiency 92 %
Peak intensity 2.2 cd/lm
LEDs/each optic 1
Light colour/type White
Required components:

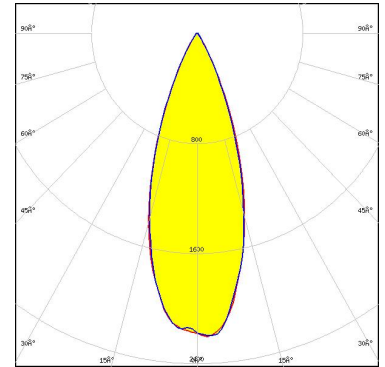

Bender Wirth: 637a Hekla

[Light distribution files](#)



LED LUXEON CoB 1202/1203
Ordering code CP19039_AMY-70-W-C2
FWHM / FWTM 32.0° / 50.0°
Efficiency 91 %
Peak intensity 3 cd/lm
LEDs/each optic 1
Light colour/type White
Required components:
F15858_HEKLA-SOCKET-H

[Light distribution files](#)



LED LUXEON CoB 1204/1205
Ordering code CP19039_AMY-70-W-C2
FWHM / FWTM 35.0° / 57.0°
Efficiency 91 %
Peak intensity 2.4 cd/lm
LEDs/each optic 1
Light colour/type White
Required components:

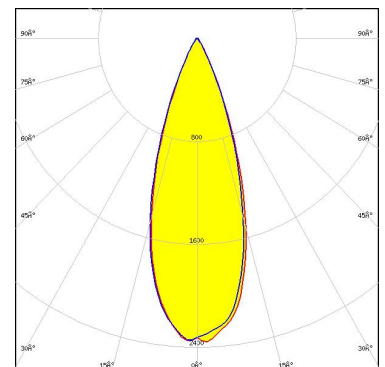

Bender Wirth: 632a Hekla XL

[Light distribution files](#)

OPTICAL RESULTS (SIMULATED):



LED LUXEON CoB 1204HD
Ordering code CP19039_AMY-70-W-C2
FWHM / FWTM 32.0° / 50.0°
Efficiency 91 %
Peak intensity 3 cd/lm
LEDs/each optic 1
Light colour/type White
Required components:
F15858_HEKLA-SOCKET-H

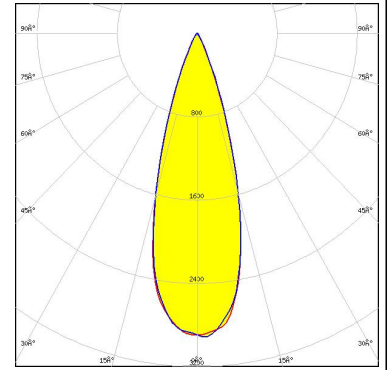

Light distribution files



LED LUXEON CoB 1205HD
Ordering code CP19039_AMY-70-W-C2
FWHM / FWTM 33.0° / 54.0°
Efficiency 91 %
Peak intensity 2.7 cd/lm
LEDs/each optic 1
Light colour/type White
Required components:
F15858_HEKLA-SOCKET-H

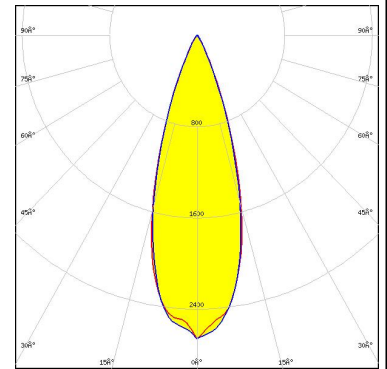

Light distribution files



LED LUXEON CoB 1208
Ordering code CP19039_AMY-70-W-C2
FWHM / FWTM 35.0° / 59.0°
Efficiency 90 %
Peak intensity 2.3 cd/lm
LEDs/each optic 1
Light colour/type White
Required components:

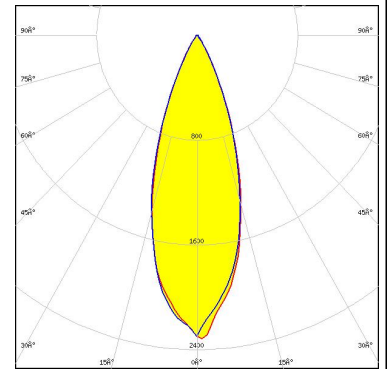

Light distribution files

Bender Wirth: 632a Hekla XL

OPTICAL RESULTS (SIMULATED):



LED LUXEON CX Plus CoB - HD S02H6
Ordering code CP19092_AMY-70-W-B2
FWHM / FWTM 29.0° / 47.0°
Efficiency 93 %
Peak intensity 3.5 cd/lm
LEDs/each optic 1
Light colour/type White
Required components:

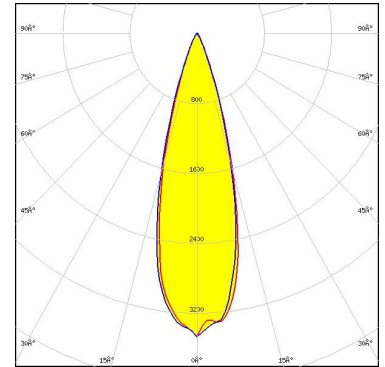

Bender Wirth: 634c Bayonet35L

Light distribution files



LED LUXEON CX Plus CoB - HD S04H9
Ordering code CP19039_AMY-70-W-C2
FWHM / FWTM 32.0° / 51.0°
Efficiency 89 %
Peak intensity 2.8 cd/lm
LEDs/each optic 1
Light colour/type White
Required components:
F15255_HEKLA-SOCKET-C

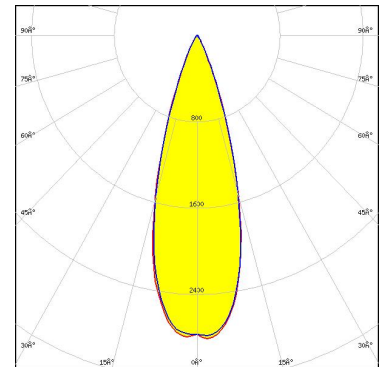

Light distribution files



LED LUXEON CX Plus CoB - HD S04H9
Ordering code CP19092_AMY-70-W-B2
FWHM / FWTM 32.0° / 50.0°
Efficiency 92 %
Peak intensity 3 cd/lm
LEDs/each optic 1
Light colour/type White
Required components:

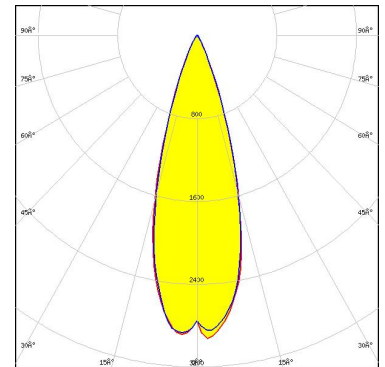

Bender Wirth: 634a Bayonet35L

Light distribution files

OPTICAL RESULTS (SIMULATED):



LED LUXEON CX Plus CoB - HD S04H9
Ordering code C17778_AMY-70-W
FWHM / FWTM 32.0° / 50.0°
Efficiency 95 %
Peak intensity 2.9 cd/lm
LEDs/each optic 1
Light colour/type White
Required components:

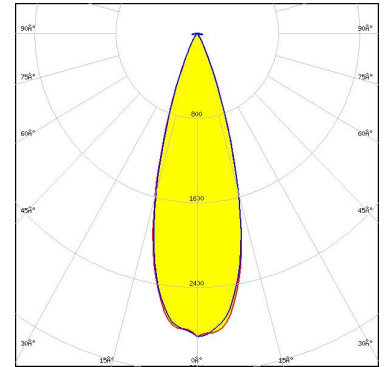

Light distribution files



LED LUXEON CX Plus CoB L04 / L05 (Gen2)
Ordering code CP19039_AMY-70-W-C2
FWHM / FWTM 35.0° / 56.0°
Efficiency 92 %
Peak intensity 2.5 cd/lm
LEDs/each optic 1
Light colour/type White
Required components:
F15254_HEKLA-SOCKET-B

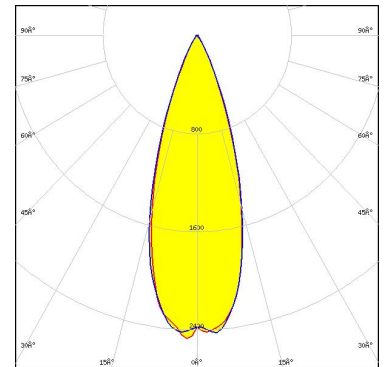

Light distribution files



LED LUXEON CX Plus CoB M02 / M03 (Gen2)
Ordering code CP19039_AMY-70-W-C2
FWHM / FWTM 31.0° / 50.0°
Efficiency 92 %
Peak intensity 3 cd/lm
LEDs/each optic 1
Light colour/type White
Required components:
F15256_HEKLA-SOCKET-D

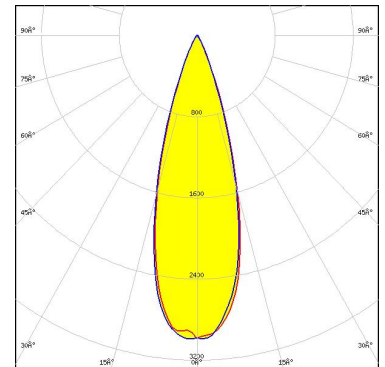

Light distribution files

OPTICAL RESULTS (SIMULATED):



LED LUXEON CX Plus CoB S01 (Gen2)
Ordering code CP19039_AMY-70-W-C2
FWHM / FWTM 28.0° / 46.0°
Efficiency 93 %
Peak intensity 3.7 cd/lm
LEDs/each optic 1
Light colour/type White
Required components:
F15956_HEKLA-SOCKET-J

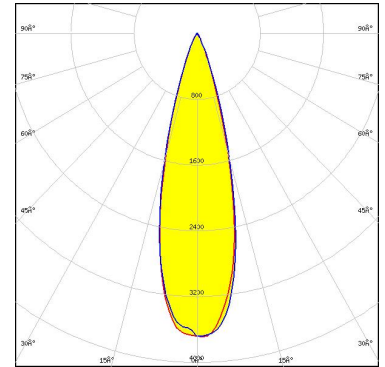

Light distribution files



LED CHM-9 XH (19x19)
Ordering code CP19039_AMY-70-W-C2
FWHM / FWTM 31.0° / 50.0°
Efficiency 93 %
Peak intensity 3.2 cd/lm
LEDs/each optic 1
Light colour/type White
Required components:
F15859_HEKLA-SOCKET-I

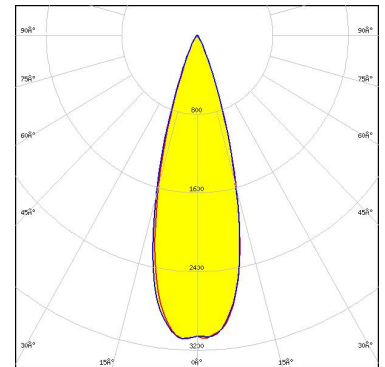

Light distribution files



LED CTM-6 (Tunable White) Gen2
Ordering code CP19039_AMY-70-W-C2
FWHM / FWTM 28.0° / 46.0°
Efficiency 93 %
Peak intensity 3.5 cd/lm
LEDs/each optic 1
Light colour/type Tunable White
Required components:
C16142_HEKLA-SOCKET-K

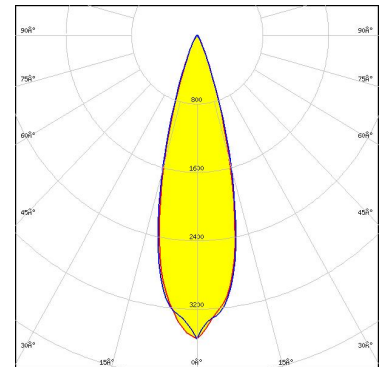

Light distribution files

Bender Wirth: 495 Typ L8

OPTICAL RESULTS (SIMULATED):



LED CXM-3
Ordering code CP19092_AMY-70-W-B2
FWHM / FWTM 25.0° / 42.0°
Efficiency 93 %
Peak intensity 4.4 cd/lm
LEDs/each optic 1
Light colour/type White
Required components:

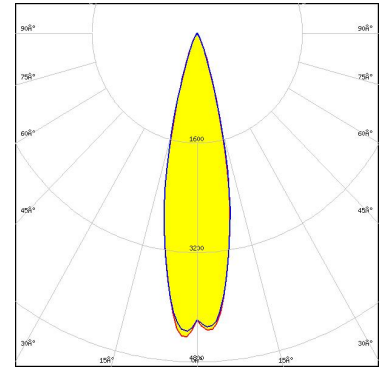

Bender Wirth: 634a Bayonet35L

Light distribution files



LED CXM-4
Ordering code CP19092_AMY-70-W-B2
FWHM / FWTM 26.0° / 44.0°
Efficiency 93 %
Peak intensity 4.1 cd/lm
LEDs/each optic 1
Light colour/type White
Required components:

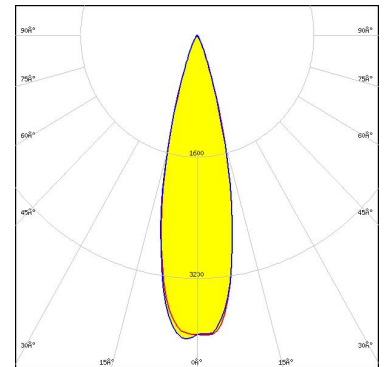

Bender Wirth: 634a Bayonet35L

Light distribution files



LED CxM-6 (13.5x13.5)
Ordering code CP19092_AMY-70-W-B2
FWHM / FWTM 28.0° / 46.0°
Efficiency 93 %
Peak intensity 3.7 cd/lm
LEDs/each optic 1
Light colour/type White
Required components:

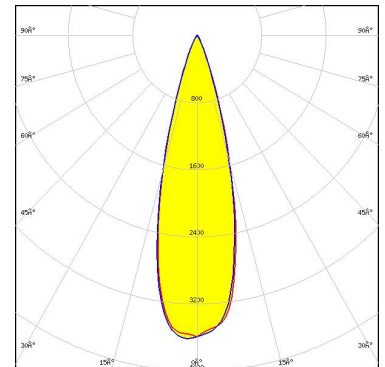

BJB: 47.360.1020

Light distribution files

OPTICAL RESULTS (SIMULATED):



LED COB J-Type
Ordering code CP19039_AMY-70-W-C2
FWHM / FWTM 35.0° / 59.0°
Efficiency 92 %
Peak intensity 2.3 cd/lm
LEDs/each optic 1
Light colour/type White
Required components:

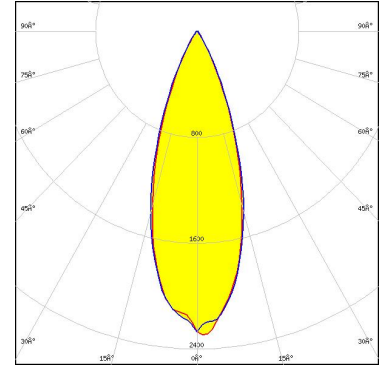

Bender Wirth: 663a Hekla XL

Light distribution files



LED COB L-Type (LES 11)
Ordering code CP19039_AMY-70-W-C2
FWHM / FWTM 33.0° / 56.0°
Efficiency 89 %
Peak intensity 2.5 cd/lm
LEDs/each optic 1
Light colour/type White
Required components:
F17437_HEKLA-G2-H

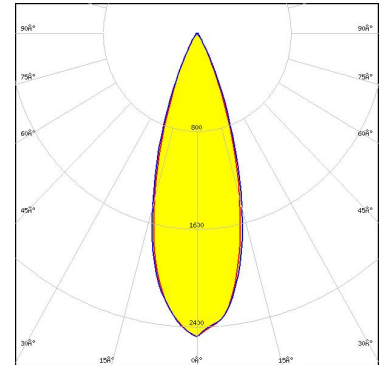

Light distribution files



LED COB S-Type (LES 6)
Ordering code CP19092_AMY-70-W-B2
FWHM / FWTM 28.0° / 46.0°
Efficiency 93 %
Peak intensity 3.5 cd/lm
LEDs/each optic 1
Light colour/type White
Required components:

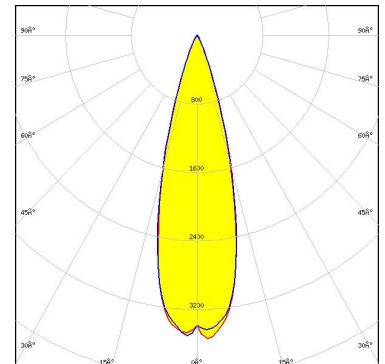

Bender Wirth: 652a Bayonet35L

Light distribution files

OPTICAL RESULTS (SIMULATED):



LED COB S-Type (LES 7)
Ordering code CP19092_AMY-70-W-B2
FWHM / FWTM 29.0° / 47.0°
Efficiency 92 %
Peak intensity 3.5 cd/lm
LEDs/each optic 1
Light colour/type White
Required components:

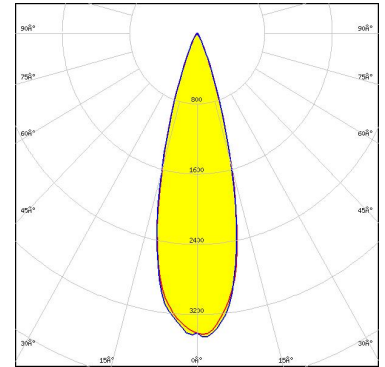

Bender Wirth: 652a Bayonet35L

Light distribution files



LED COB T-Type
Ordering code CP19092_AMY-70-W-B2
FWHM / FWTM 30.0° / 46.0°
Efficiency 92 %
Peak intensity 3.5 cd/lm
LEDs/each optic 1
Light colour/type White
Required components:

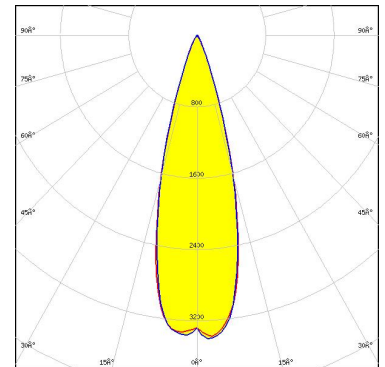

Bender Wirth: 652a Bayonet35L

Light distribution files



LED NJCWL024Z-V1MT: COB L-Type Tunable White
Ordering code CP19039_AMY-70-W-C2
FWHM / FWTM 29.0° / 48.0°
Efficiency 93 %
Peak intensity 3.5 cd/lm
LEDs/each optic 1
Light colour/type Tunable White
Required components:
C16142_HEKLA-SOCKET-K

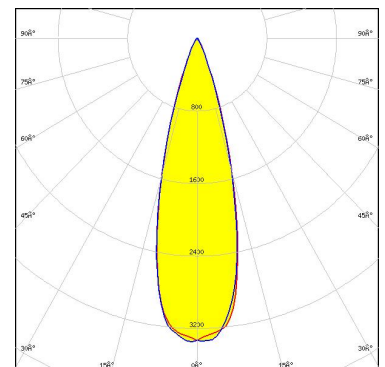

Bender Wirth: 497 Typ L8 HV

Light distribution files

OPTICAL RESULTS (SIMULATED):



LED NJNWS012Z-V1MT: COB S-Type Tunable White
Ordering code CP19039_AMY-70-W-C2
FWHM / FWTM 26.0° / 44.0°
Efficiency 93 %
Peak intensity 3.9 cd/lm
LEDs/each optic 1
Light colour/type Tunable White
Required components:
C16142_HEKLA-SOCKET-K

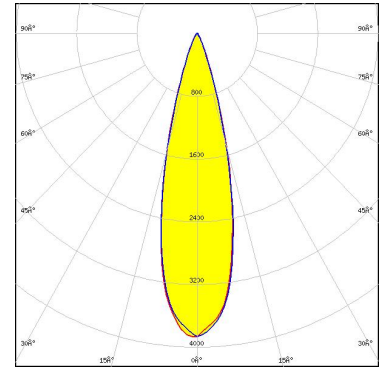

Light distribution files

Bender Wirth: 495 Typ L8 HV



LED NVCWJ024Z-V1MT: COB J-Type Tunable White
Ordering code CP19039_AMY-70-W-C2
FWHM / FWTM 32.0° / 54.0°
Efficiency 92 %
Peak intensity 2.8 cd/lm
LEDs/each optic 1
Light colour/type Tunable White
Required components:
C16142_HEKLA-SOCKET-K

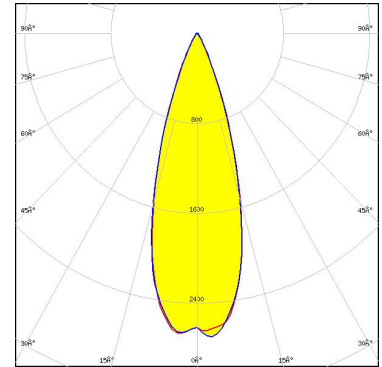

Light distribution files

Bender Wirth: 498 Typ L8 HV



LED Fortimo SLM L15 CoB
Ordering code CP19039_AMY-70-W-C2
FWHM / FWTM 34.0° / 60.0°
Efficiency 89 %
Peak intensity 2.2 cd/lm
LEDs/each optic 1
Light colour/type White
Required components:

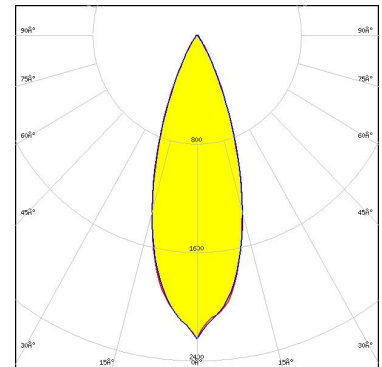

Light distribution files

Bender Wirth: 632a Hekla XL

OPTICAL RESULTS (SIMULATED):

SAMSUNG

LED LC003D / LC006D / LC009D / LC013D
Ordering code CP19039_AMY-70-W-C2
FWHM / FWTM 33.0° / 56.0°
Efficiency 90 %
Peak intensity 2.6 cd/lm
LEDs/each optic 1
Light colour/type White
Required components:
F15255_HEKLA-SOCKET-C

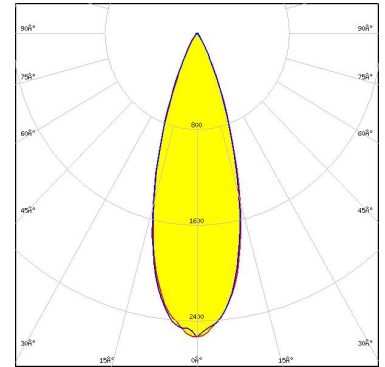

Light distribution files

SAMSUNG

LED LC010C G2
Ordering code CP19092_AMY-70-W-B2
FWHM / FWTM 28.0° / 46.0°
Efficiency 93 %
Peak intensity 3.7 cd/lm
LEDs/each optic 1
Light colour/type White
Required components:

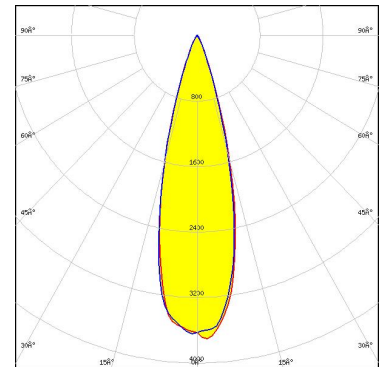

Light distribution files

BJB: 47.360.1020

SAMSUNG

LED LC010T (Tunable White)
Ordering code CP19039_AMY-70-W-C2
FWHM / FWTM 30.0° / 49.0°
Efficiency 93 %
Peak intensity 3.2 cd/lm
LEDs/each optic 1
Light colour/type Tunable White
Required components:

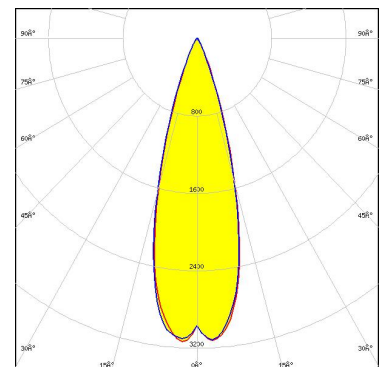

Light distribution files

Bender Wirth: 501 Typ L8

OPTICAL RESULTS (SIMULATED):

SAMSUNG

LED LC016D / LC019D / LC026D / LC033D
Ordering code CP19039_AMY-70-W-C2
FWHM / FWTM 36.0° / 66.0°
Efficiency 87 %
Peak intensity 1.9 cd/lm
LEDs/each optic 1
Light colour/type White
Required components:
F15859_HEKLA-SOCKET-I

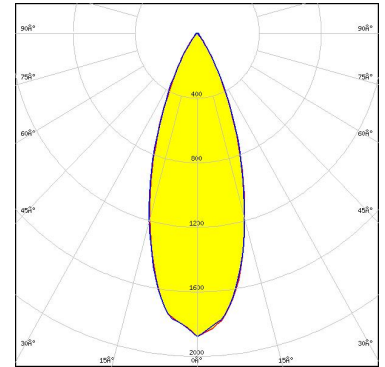

Light distribution files

SAMSUNG

LED LC020C G2
Ordering code CP19092_AMY-70-W-B2
FWHM / FWTM 31.0° / 50.0°
Efficiency 92 %
Peak intensity 3.1 cd/lm
LEDs/each optic 1
Light colour/type White
Required components:

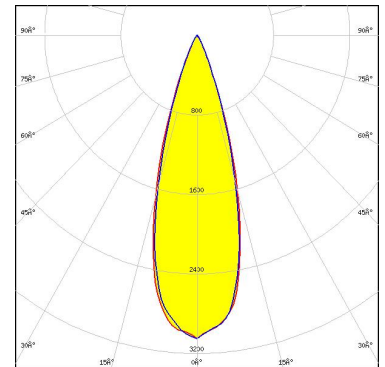

Light distribution files

BJB: 47.360.1010

SAMSUNG

LED LC020T (Tunable white)
Ordering code CP19039_AMY-70-W-C2
FWHM / FWTM 34.0° / 58.0°
Efficiency 89 %
Peak intensity 2.3 cd/lm
LEDs/each optic 1
Light colour/type White
Required components:
F15859_HEKLA-SOCKET-I

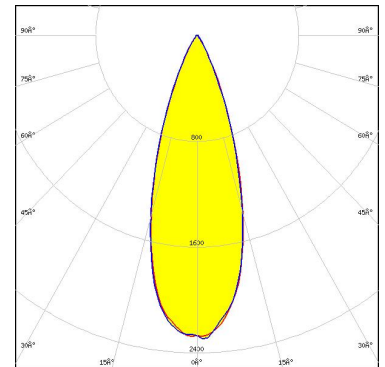

Light distribution files

OPTICAL RESULTS (SIMULATED):

SAMSUNG

LED LC020T (Tunable white)
Ordering code CP19039_AMY-70-W-C2
FWHM / FWTM 34.0° / 54.0°
Efficiency 92 %
Peak intensity 2.7 cd/lm
LEDs/each optic 1
Light colour/type Tunable White
Required components:
C16142_HEKLA-SOCKET-K

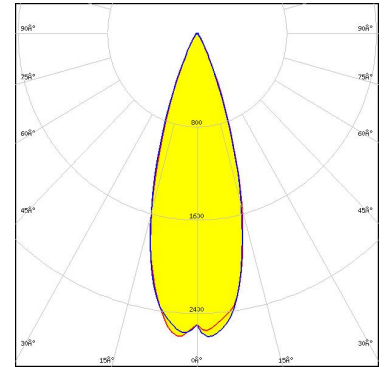

Light distribution files

Bender Wirth: 501 Typ L8

SAMSUNG

LED LC030C/040C G2
Ordering code CP19092_AMY-70-W-B2
FWHM / FWTM 34.0° / 54.0°
Efficiency 91 %
Peak intensity 2.6 cd/lm
LEDs/each optic 1
Light colour/type White
Required components:

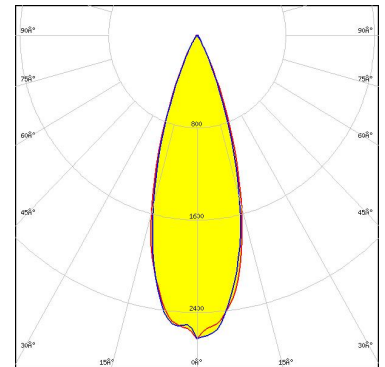

Light distribution files

BJB: 47.360.1010



LED MJT COB LES 14.5
Ordering code CP19039_AMY-70-W-C2
FWHM / FWTM 36.0° / 61.0°
Efficiency 88 %
Peak intensity 2.1 cd/lm
LEDs/each optic 1
Light colour/type White
Required components:
F17438_HEKLA-G2-I

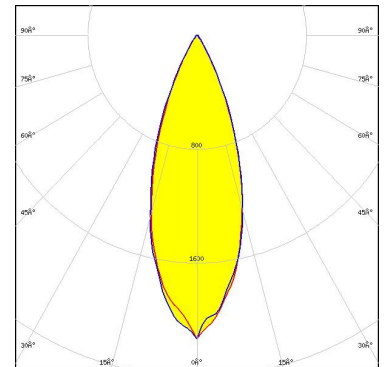

Light distribution files

OPTICAL RESULTS (SIMULATED):

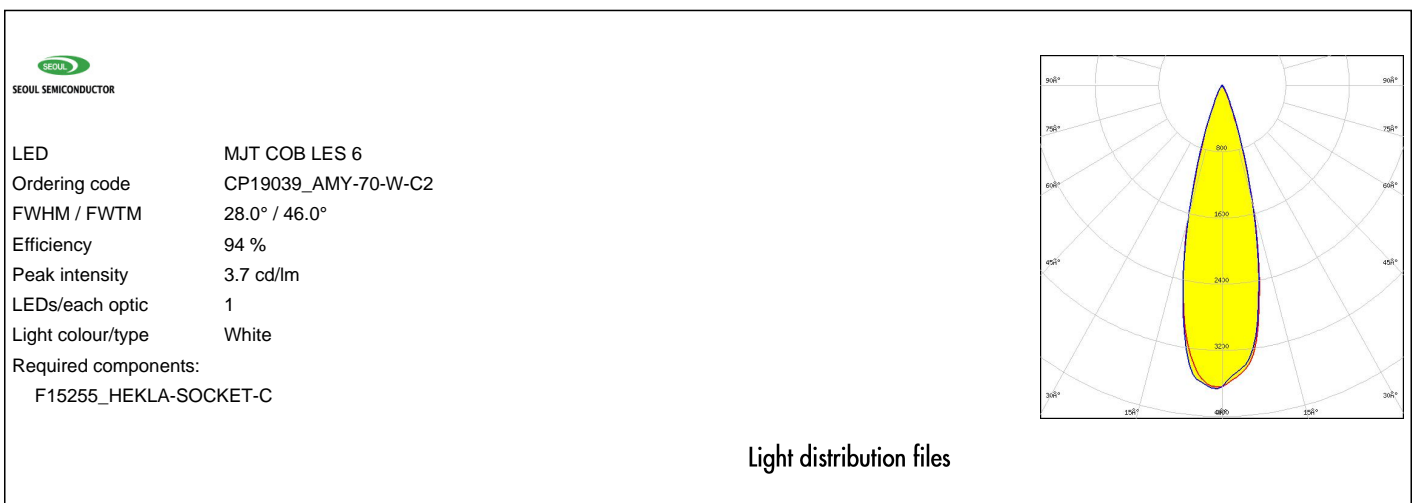
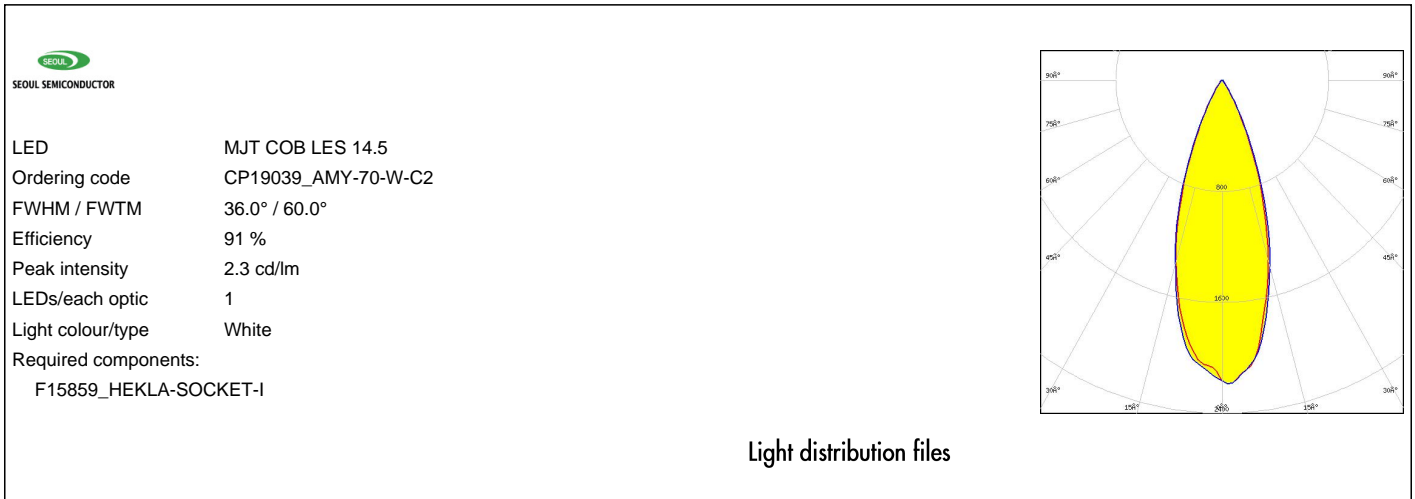

OPTICAL RESULTS (SIMULATED):

TRIDONIC

LED SLE G7 LES13
Ordering code CP19039_AMY-70-W-C2
FWHM / FWTM 36.0° / 58.0°
Efficiency 90 %
Peak intensity 2.3 cd/lm
LEDs/each optic 1
Light colour/type White
Required components:
F17438_HEKLA-G2-I

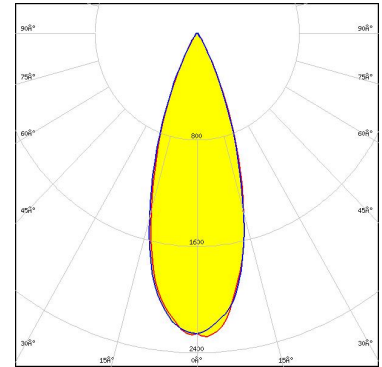

Light distribution files

XICATO

LED XOB 14.5 mm
Ordering code CP19039_AMY-70-W-C2
FWHM / FWTM 33.0° / 56.0°
Efficiency 81 %
Peak intensity 2.3 cd/lm
LEDs/each optic 1
Light colour/type White
Required components:
F17438_HEKLA-G2-I

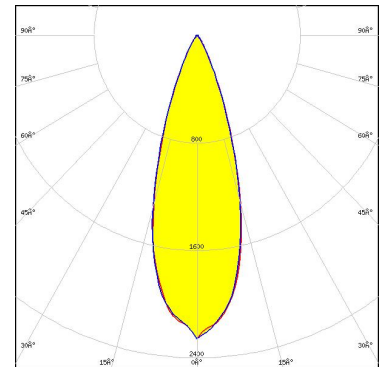

Light distribution files

GENERAL INFORMATION:

NOTE: The typical beam angle will be changed by different color, chip size and chip position tolerance. The typical total beam angle is the full angle measured where the luminous intensity is half of the peak value.

Due to use of high power COB's with this product, special attention to proper thermal design is highly recommended. LEDiL has no liability for direct, indirect or consecutive damages arising from the LEDiL products being used outside of the recommended temperature range.

MATERIALS:

As part of our continuous research and improvement processes, and to ensure the best possible quality and availability of our products, LEDiL reserves the right to change material grades without notice.

PRODUCT DATA USER AGREEMENT AND DISCLAIMER:

The measured data in the provided downloadable LEDiL Product Datasheets and Mechanical 2D-Drawings is rounded and provided as reference for planning. LEDiL Oy's optical specifications have been verified by conducting performance testing of the products in accordance with the company's quality system. The reported data are averaged results of multiple measurements with typical variation. LEDiL Oy reserves the right to without prior notification make changes and improvements to its products.

LEDiL Oy assumes neither warranty, nor guarantee nor any other liability of any kind for the contents and correctness of the provided data. The provided data has been generated with highest diligence but the provided data may in reality not represent the complete possible variation range of all intrinsic parameters. Therefore, in certain cases a deviation from the provided data could occur.

LEDiL Oy reserves the right to undertake technical changes of its products without further notification which could lead to changes in the provided data. LEDiL Oy assumes no liability of any kind for the possible deviation from any provided data or any other damage resulting from the usage of the provided data.

The user agrees to this disclaimer and user agreement with the download or usage of the provided files.

LEDiL Oy

Joensuunkatu 7
FI-24240 SALO
Finland

LEDiL Inc.

228 West Page Street
Suite D
Sycamore IL 60178
USA

Ledil Optics Technology (Shenzhen) Co., Ltd.

405 , Block B
Casic Motor Building
Shenzhen 518057
P.R.CHINA

Local sales and technical support

[www.ledil.com/
where_to_buy](http://www.ledil.com/where_to_buy)

Shipping locations

Poznan, Poland
Hong Kong, China

Distribution Partners

[www.ledil.com/
where_to_buy](http://www.ledil.com/where_to_buy)