

AMY-70-M

~24° medium beam

SPECIFICATION:

Dimensions	Ø 69.9
Height	12.8 mm
Fastening	socket
ROHS compliant	yes ⓘ

MATERIALS:

Component	Type	Material	Colour	Finish	Length (mm)
AMY-70-M	Single lens	PMMA	clear		
AMY-70-HLD2-C	Holder C	PC	black		
AMY-70-HLD2-B	Holder B	PC	black		
AMY-70-HLD2-C-WHT	Holder C	PC	white		
AMY-70-HLD2-B-WHT	Holder B	PC	white		
AMY-70-HLD2-B50	Holder B	PC	black		
AMY-70-HLD2-B50-WHT	Holder B	PC	white		



ORDERING INFORMATION:

Component	Qty in box	MOQ	MPQ	Box weight (kg)
C17777_AMY-70-M	285	285	15	9.2
Assembly				
CP19652_AMY-70-M-B50-WHT	210	210	15	8.7
CP19644_AMY-70-M-B50	210	210	15	8.4
CP19116_AMY-70-M-B2-WHT	210	210	15	8.7
CP19108_AMY-70-M-C2-WHT	210	210	15	8.4
CP19091_AMY-70-M-B2	210	210	15	8.7
CP19038_AMY-70-M-C2	210	210	15	8.4

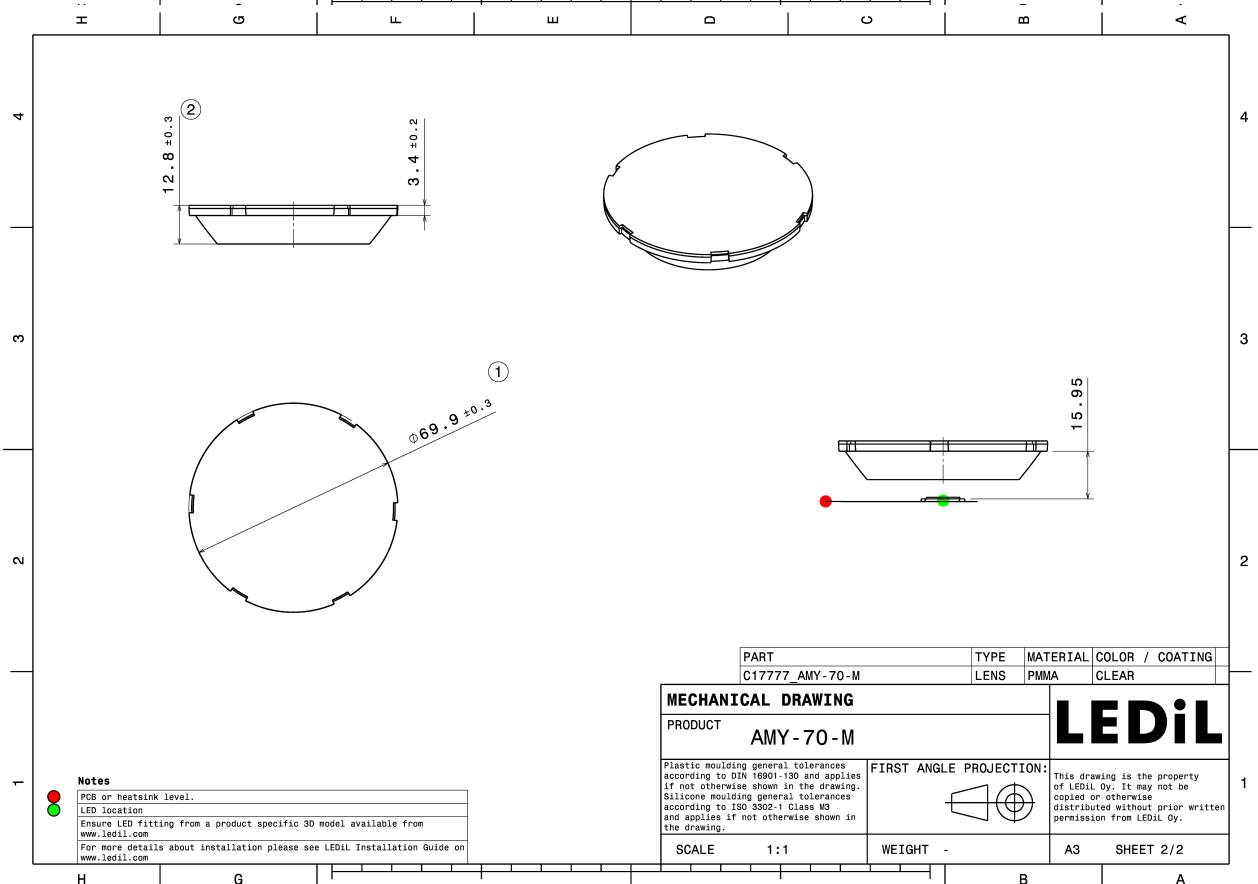
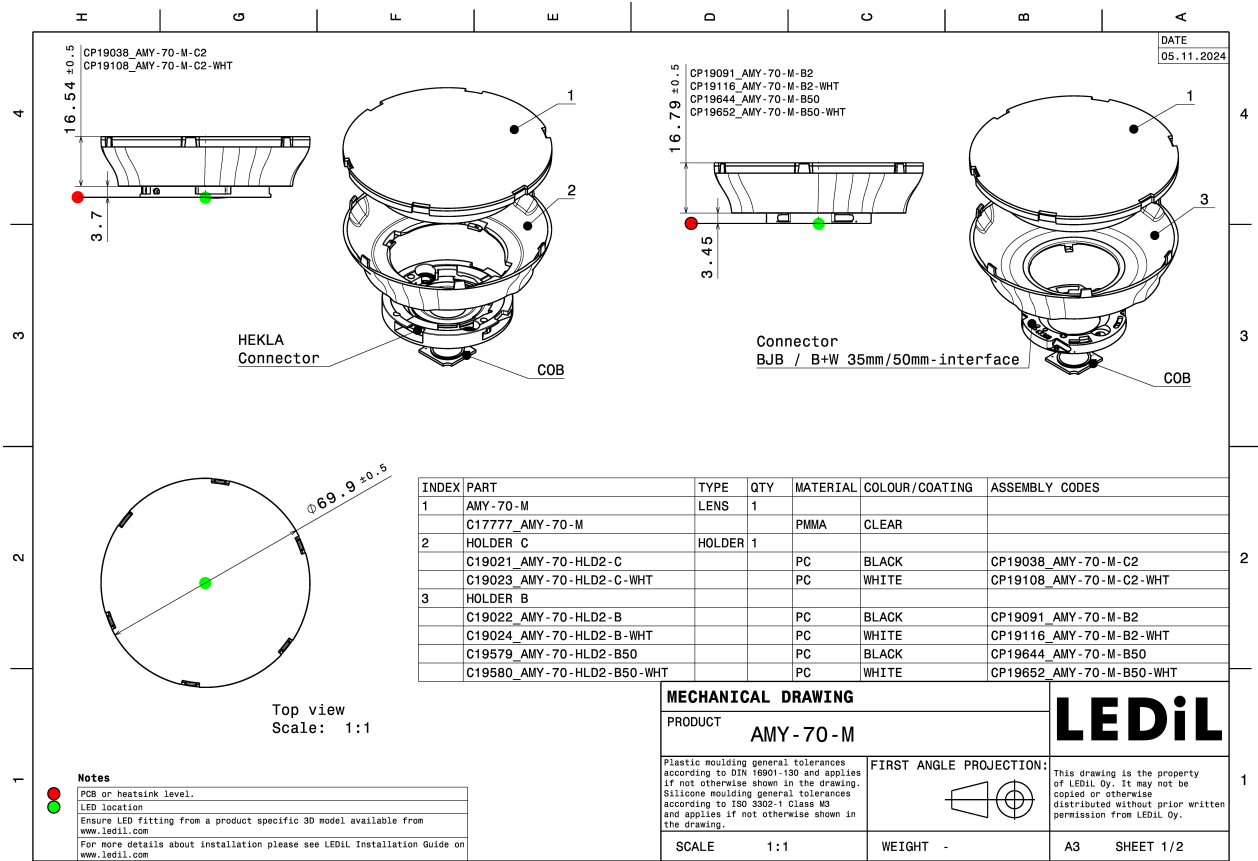

See also our general installation guide: www.ledil.com/installation_guide

OPTICAL RESULTS (MEASURED):



LED V10 Gen 8-9
Ordering code CP19038_AMY-70-M-C2
FWHM / FWTM 23.0° / 42.0°
Efficiency 92 %
LEDs/each optic 1
Light colour/type White
Required components:
 F15255_HEKLA-SOCKET-C

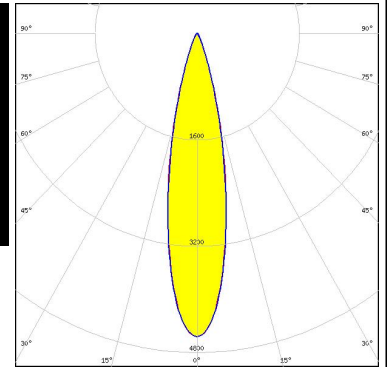

Light distribution files



LED V11 HD Gen 8
Ordering code CP19038_AMY-70-M-C2
FWHM / FWTM 23.0° / 44.0°
Efficiency 90 %
LEDs/each optic 1
Light colour/type White
Required components:
 Bender Wirth: 633d Hekla

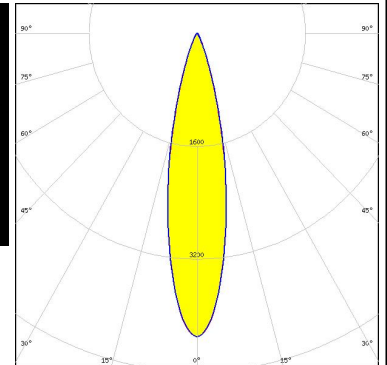

Light distribution files



LED V13 Gen 8-9
Ordering code CP19038_AMY-70-M-C2
FWHM / FWTM 26.0° / 51.0°
Efficiency 89 %
LEDs/each optic 1
Light colour/type White
Required components:
 F15859_HEKLA-SOCKET-I

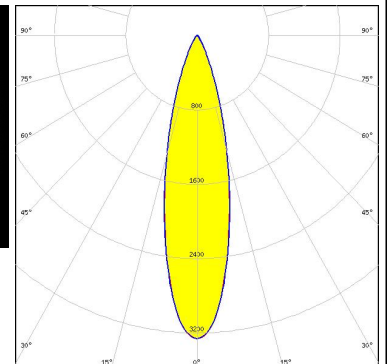
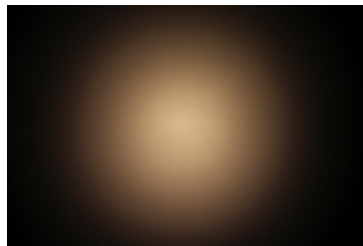

Light distribution files

OPTICAL RESULTS (MEASURED):



LED V8 Gen 8-9
Ordering code CP19038_AMY-70-M-C2
FWHM / FWTM 22.0° / 40.0°
Efficiency 93 %
LEDs/each optic 1
Light colour/type White
Required components:
 F15253_HEKLA-SOCKET-A

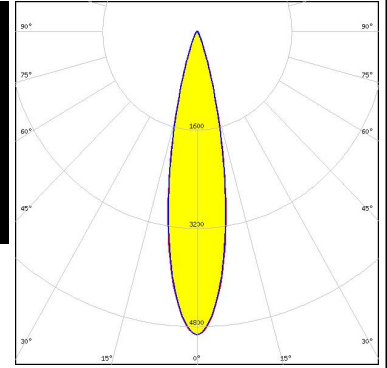

Light distribution files

CITIZEN

LED CLL02x/CLU02x (LES10)
Ordering code CP19038_AMY-70-M-C2
FWHM / FWTM 22.0° / 41.0°
Efficiency 90 %
LEDs/each optic 1
Light colour/type White
Required components:
 F17435_HEKLA-G2-C

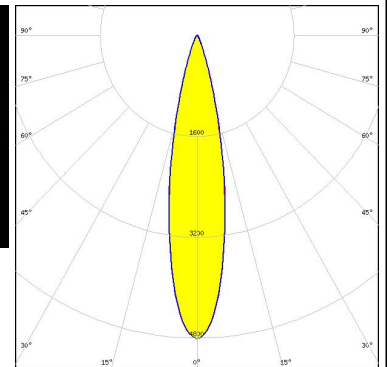
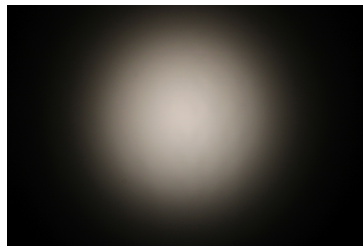

Light distribution files



LED CMU15xx
Ordering code CP19038_AMY-70-M-C2
FWHM / FWTM 26.0° / 51.0°
Efficiency 88 %
LEDs/each optic 1
Light colour/type White
Required components:
 F17438_HEKLA-G2-I

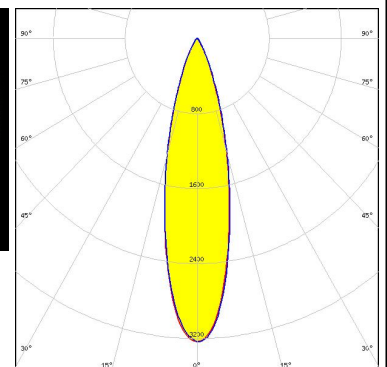
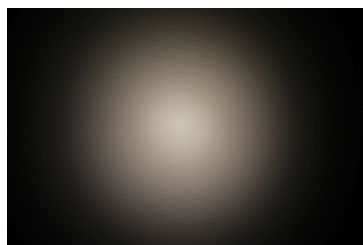

Light distribution files

OPTICAL RESULTS (MEASURED):



LED LUXEON Fusion 12-up (20x24)
Ordering code CP19038_AMY-70-M-C2
FWHM / FWTM 22.0° / 41.0°
Efficiency 84 %
LEDs/each optic 1
Light colour/type White
Required components:
C16142_HEKLA-SOCKET-K
F18158_HEKLA-RZ-LENS
Bender Wirth: 442 Typ L8

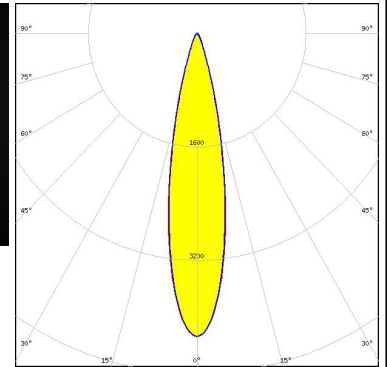
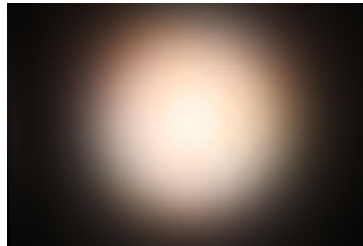

Light distribution files



LED LUXEON Fusion 21-up (20x24)
Ordering code CP19038_AMY-70-M-C2
FWHM / FWTM 23.0° / 42.0°
Efficiency 82 %
LEDs/each optic 1
Light colour/type White
Required components:
C16142_HEKLA-SOCKET-K
F18158_HEKLA-RZ-LENS
Bender Wirth: 442 Typ L8

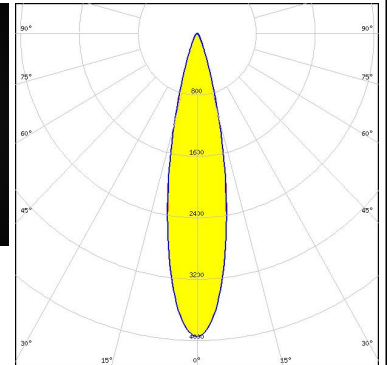
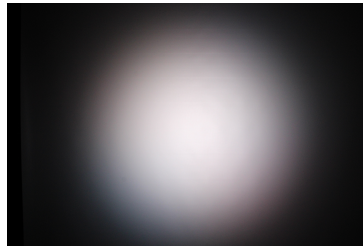

Light distribution files



LED LUXEON Fusion 27-up (20x24)
Ordering code CP19038_AMY-70-M-C2
FWHM / FWTM 26.0° / 48.0°
Efficiency 82 %
LEDs/each optic 1
Light colour/type White
Required components:
C16142_HEKLA-SOCKET-K
F18158_HEKLA-RZ-LENS
Bender Wirth: 442 Typ L8

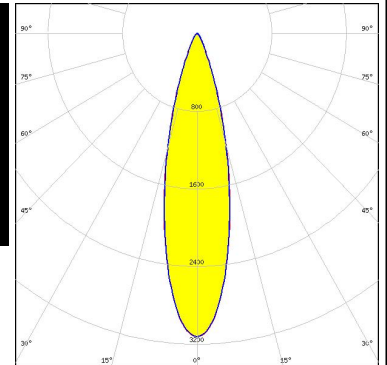

Light distribution files

OPTICAL RESULTS (MEASURED):



LED CTM-14 (Tunable White) Gen2
Ordering code CP19038_AMY-70-M-C2
FWHM / FWTM 24.5° / 48.0°
Efficiency 89 %
LEDs/each optic 1
Light colour/type White
Required components:
 C16142_HEKLA-SOCKET-K
 Bender Wirth: 442 Typ L8

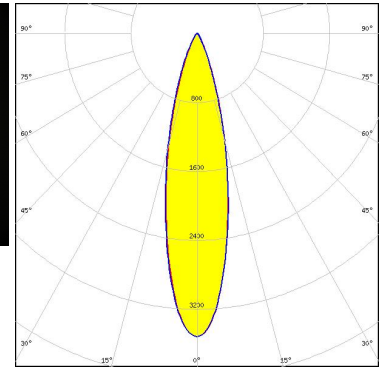
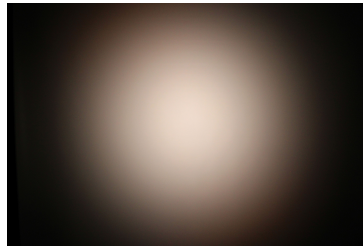

Light distribution files



LED LC016D / LC019D / LC026D / LC033D
Ordering code CP19038_AMY-70-M-C2
FWHM / FWTM 27.0° / 53.0°
Efficiency 90 %
LEDs/each optic 1
Light colour/type White
Required components:
 F15859_HEKLA-SOCKET-I

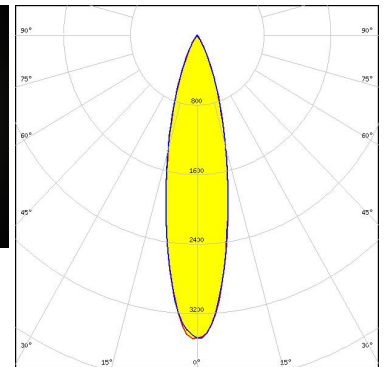
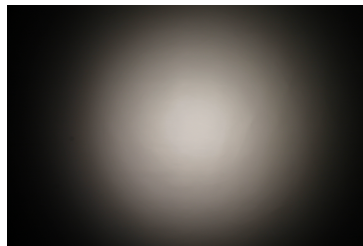

Light distribution files



LED LC016D / LC019D / LC026D / LC033D
Ordering code C17777_AMY-70-M
FWHM / FWTM 27.0° / 53.0°
Efficiency 90 %
LEDs/each optic 1
Light colour/type White
Required components:

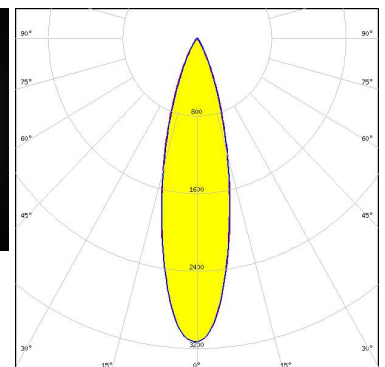
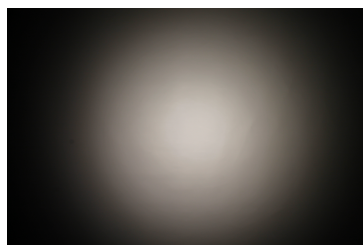

Light distribution files

OPTICAL RESULTS (SIMULATED):



LED V13 Gen7
Ordering code CP19038_AMY-70-M-C2
FWHM / FWTM 24.0° / 51.0°
Efficiency 92 %
Peak intensity 3.8 cd/lm
LEDs/each optic 1
Light colour/type White
Required components:

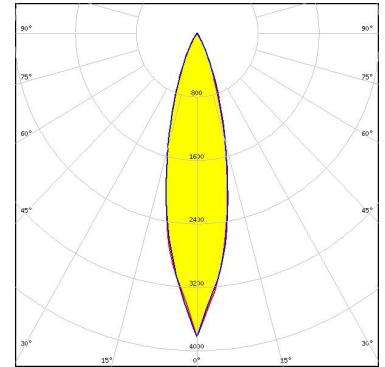

Light distribution files



LED V18 Gen 8-9
Ordering code CP19038_AMY-70-M-C2
FWHM / FWTM 32.0° / 61.0°
Efficiency 86 %
Peak intensity 2.4 cd/lm
LEDs/each optic 1
Light colour/type White
Required components:

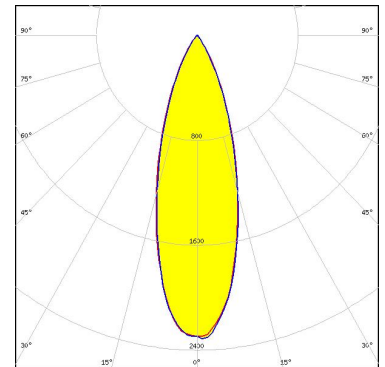

Bender Wirth: 639b Hekla XL

Light distribution files



LED V3 HD Gen 8
Ordering code CP19038_AMY-70-M-C2
FWHM / FWTM 22.0° / 32.0°
Efficiency 94 %
Peak intensity 7.1 cd/lm
LEDs/each optic 1
Light colour/type White
Required components:
 F15253_HEKLA-SOCKET-A

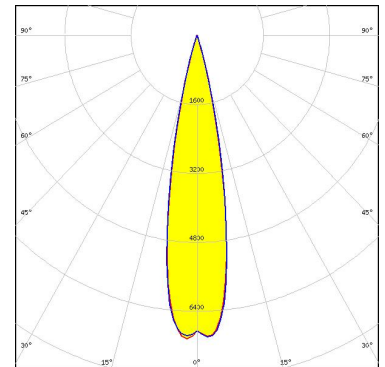

Light distribution files

OPTICAL RESULTS (SIMULATED):



LED V3 HD Gen 8 FC
Ordering code CP19038_AMY-70-M-C2
FWHM / FWTM 22.0° / 32.0°
Efficiency 93 %
Peak intensity 7.1 cd/lm
LEDs/each optic 1
Light colour/type White
Required components:
 F15255_HEKLA-SOCKET-C

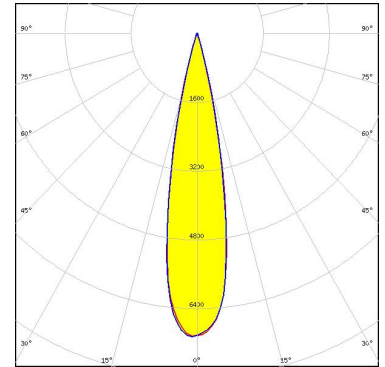

Light distribution files



LED V4 HD Gen 8
Ordering code CP19038_AMY-70-M-C2
FWHM / FWTM 22.0° / 34.0°
Efficiency 94 %
Peak intensity 7 cd/lm
LEDs/each optic 1
Light colour/type White
Required components:
 F15253_HEKLA-SOCKET-A

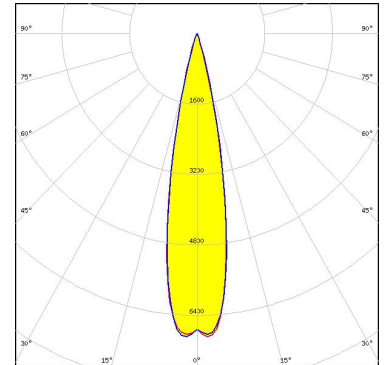

Light distribution files



LED V6 Gen 8-9
Ordering code CP19038_AMY-70-M-C2
FWHM / FWTM 22.0° / 35.0°
Efficiency 94 %
Peak intensity 6.4 cd/lm
LEDs/each optic 1
Light colour/type White
Required components:
 F15253_HEKLA-SOCKET-A

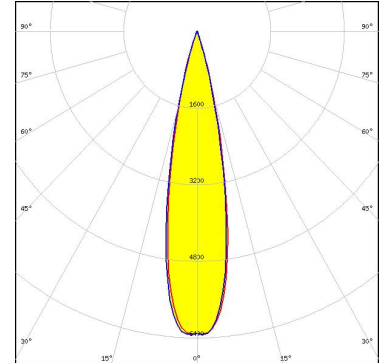

Light distribution files

OPTICAL RESULTS (SIMULATED):



LED V6 Gen 8-9
Ordering code CP19038_AMY-70-M-C2
FWHM / FWTM 22.0° / 35.0°
Efficiency 96 %
Peak intensity 6.4 cd/lm
LEDs/each optic 1
Light colour/type White
Required components:
 F15253_HEKLA-SOCKET-A

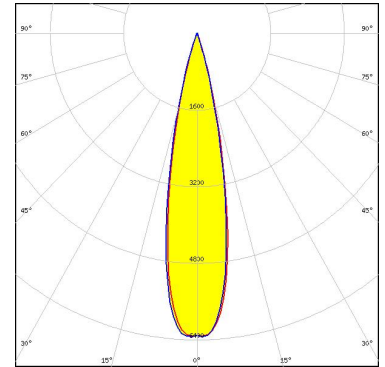

Light distribution files



LED V6 HD Gen 8
Ordering code CP19038_AMY-70-M-C2
FWHM / FWTM 20.0° / 34.0°
Efficiency 94 %
Peak intensity 7 cd/lm
LEDs/each optic 1
Light colour/type White
Required components:

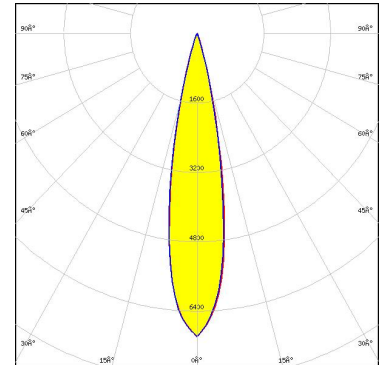

Bender Wirth: 634c Hekla

Light distribution files



LED V6 HD Gen 8
Ordering code CP19038_AMY-70-M-C2
FWHM / FWTM 22.0° / 36.0°
Efficiency 93 %
Peak intensity 6.2 cd/lm
LEDs/each optic 1
Light colour/type White
Required components:
 F15255_HEKLA-SOCKET-C

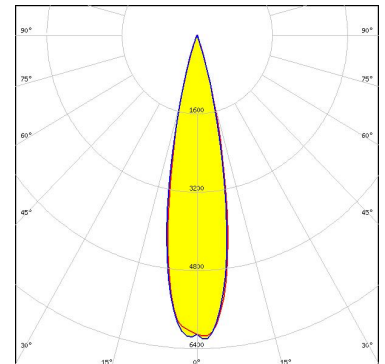

Light distribution files

OPTICAL RESULTS (SIMULATED):



LED V8 Gen 8-9
Ordering code C17777_AMY-70-M
FWHM / FWTM 21.0° / 37.0°
Efficiency 96 %
Peak intensity 6.2 cd/lm
LEDs/each optic 1
Light colour/type White
Required components:

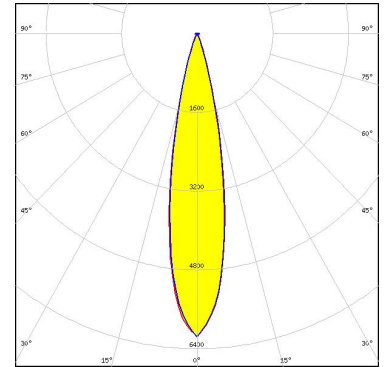

Light distribution files



LED V8 Gen7
Ordering code CP19038_AMY-70-M-C2
FWHM / FWTM 22.0° / 38.0°
Efficiency 91 %
Peak intensity 5.6 cd/lm
LEDs/each optic 1
Light colour/type White
Required components:
F15253_HEKLA-SOCKET-A

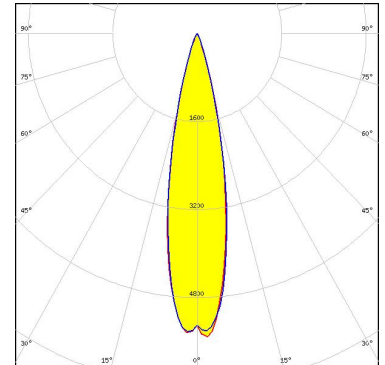

Light distribution files



LED V9 HD Gen 8
Ordering code CP19038_AMY-70-M-C2
FWHM / FWTM 22.0° / 38.0°
Efficiency 93 %
Peak intensity 5.9 cd/lm
LEDs/each optic 1
Light colour/type White
Required components:
F15859_HEKLA-SOCKET-I

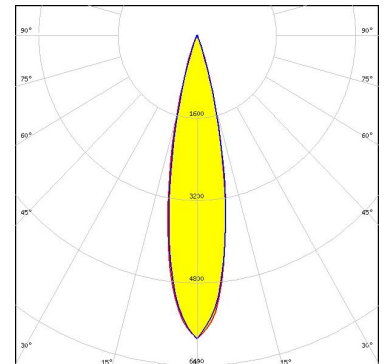

Light distribution files

OPTICAL RESULTS (SIMULATED):



LED VERO10
Ordering code CP19038_AMY-70-M-C2
FWHM / FWTM 22.0° / 39.0°
Efficiency 91 %
Peak intensity 5.4 cd/lm
LEDs/each optic 1
Light colour/type White
Required components:
F15616_HEKLA-SOCKET-F

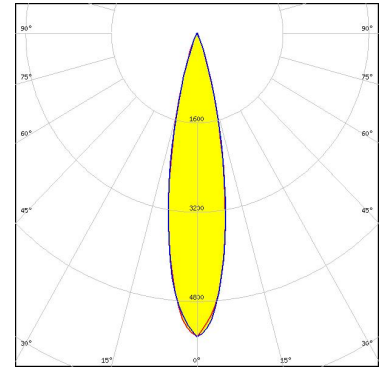

Light distribution files



LED VERO13
Ordering code CP19038_AMY-70-M-C2
FWHM / FWTM 24.0° / 44.0°
Efficiency 89 %
Peak intensity 4.4 cd/lm
LEDs/each optic 1
Light colour/type White
Required components:
C16142_HEKLA-SOCKET-K

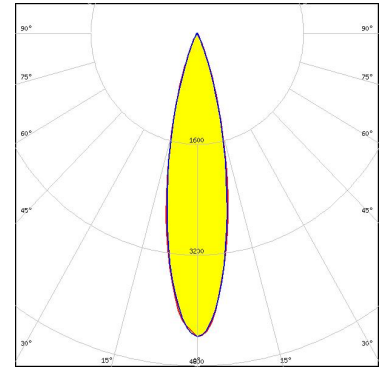

Light distribution files



LED VERO18
Ordering code CP19038_AMY-70-M-C2
FWHM / FWTM 33.0° / 62.0°
Efficiency 90 %
Peak intensity 2.3 cd/lm
LEDs/each optic 1
Light colour/type White
Required components:
C16142_HEKLA-SOCKET-K

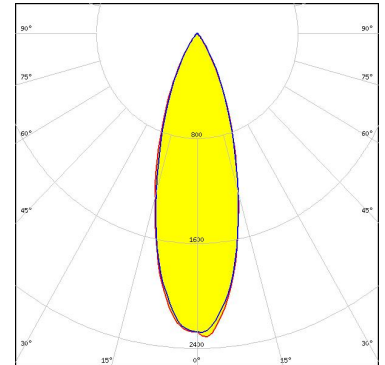

Light distribution files

OPTICAL RESULTS (SIMULATED):



LED Vesta DTW 13mm (21W)
Ordering code CP19038_AMY-70-M-C2
FWHM / FWTM 22.0° / 36.0°
Efficiency 93 %
Peak intensity 6.1 cd/lm
LEDs/each optic 1
Light colour/type White
Required components:

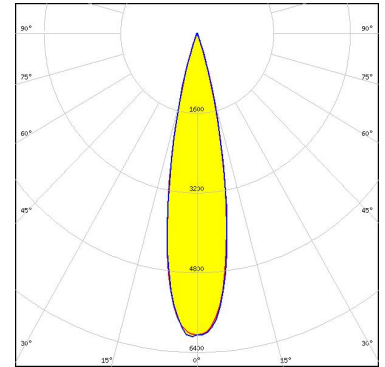

Bender Wirth: 632b Hekla XL

Light distribution files



LED Vesta DTW 15mm (33W)
Ordering code CP19038_AMY-70-M-C2
FWHM / FWTM 27.0° / 50.0°
Efficiency 91 %
Peak intensity 3.6 cd/lm
LEDs/each optic 1
Light colour/type White
Required components:

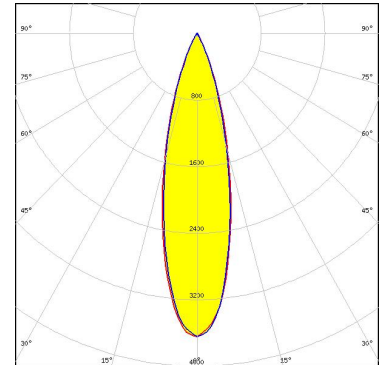

Bender Wirth: 632b Hekla XL

Light distribution files



LED Vesta DTW 6mm
Ordering code CP19038_AMY-70-M-C2
FWHM / FWTM 22.0° / 36.0°
Efficiency 93 %
Peak intensity 6.2 cd/lm
LEDs/each optic 1
Light colour/type White
Required components:

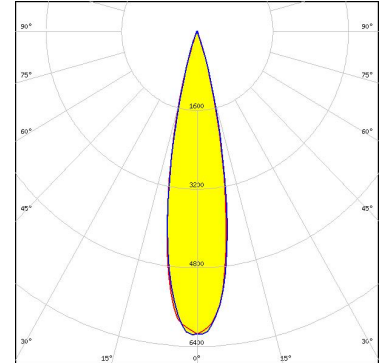

Bender Wirth: 652b Hekla

Light distribution files

OPTICAL RESULTS (SIMULATED):



LED Vesta DTW 9mm (4W/6W/12W)
Ordering code CP19038_AMY-70-M-C2
FWHM / FWTM 23.0° / 39.0°
Efficiency 87 %
Peak intensity 5.1 cd/lm
LEDs/each optic 1
Light colour/type White
Required components:
F18158_HEKLA-RZ-LENS

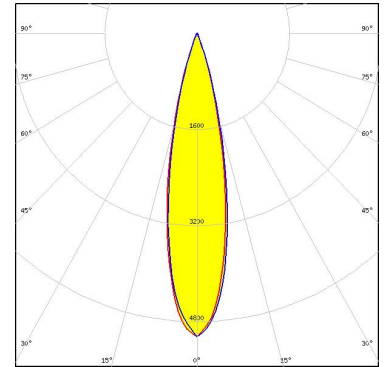

Light distribution files

Bender Wirth: 652b Hekla



LED Vesta DTW 9mm (4W/6W/12W)
Ordering code CP19038_AMY-70-M-C2
FWHM / FWTM 22.0° / 37.0°
Efficiency 91 %
Peak intensity 6 cd/lm
LEDs/each optic 1
Light colour/type White
Required components:

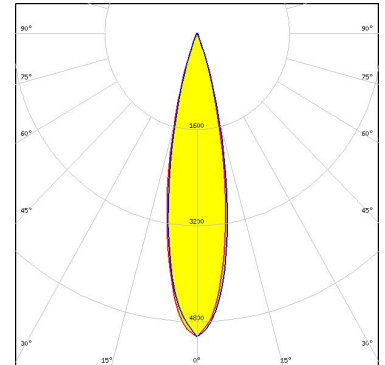

Light distribution files

Bender Wirth: 652b Hekla



LED Vesta SE 13mm TW
Ordering code CP19038_AMY-70-M-C2
FWHM / FWTM 24.0° / 45.0°
Efficiency 87 %
Peak intensity 4 cd/lm
LEDs/each optic 1
Light colour/type Tunable White
Required components:
C16142_HEKLA-SOCKET-K

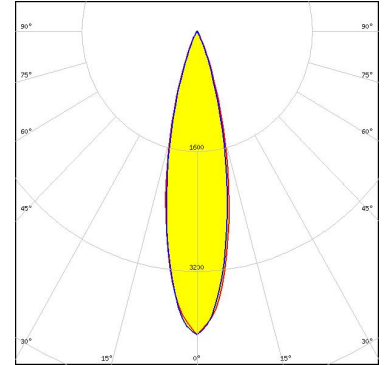

Light distribution files

OPTICAL RESULTS (SIMULATED):

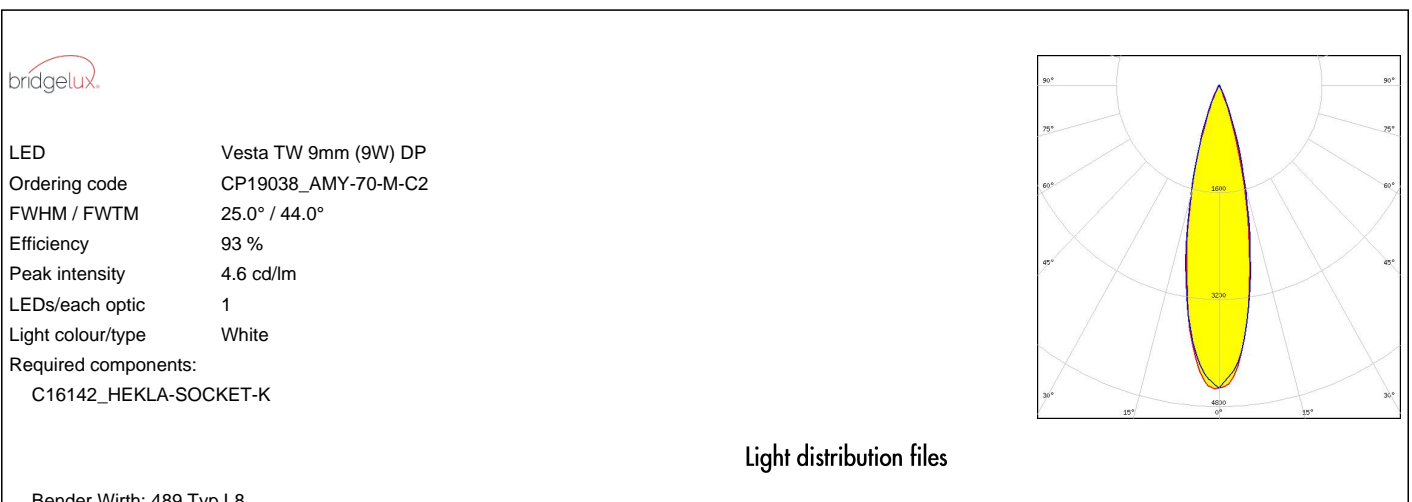
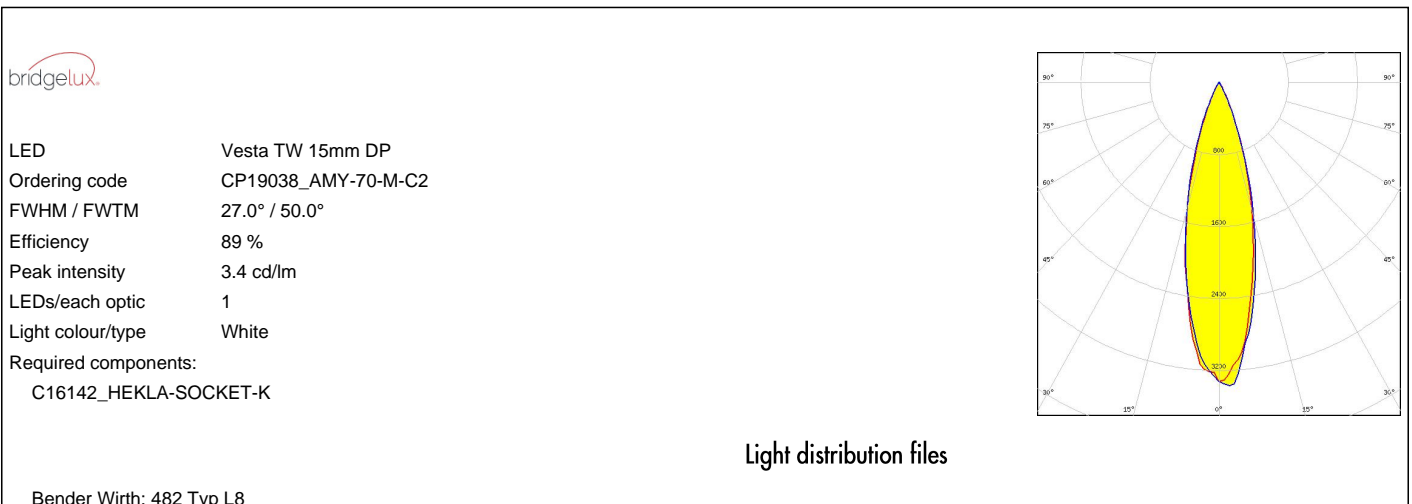
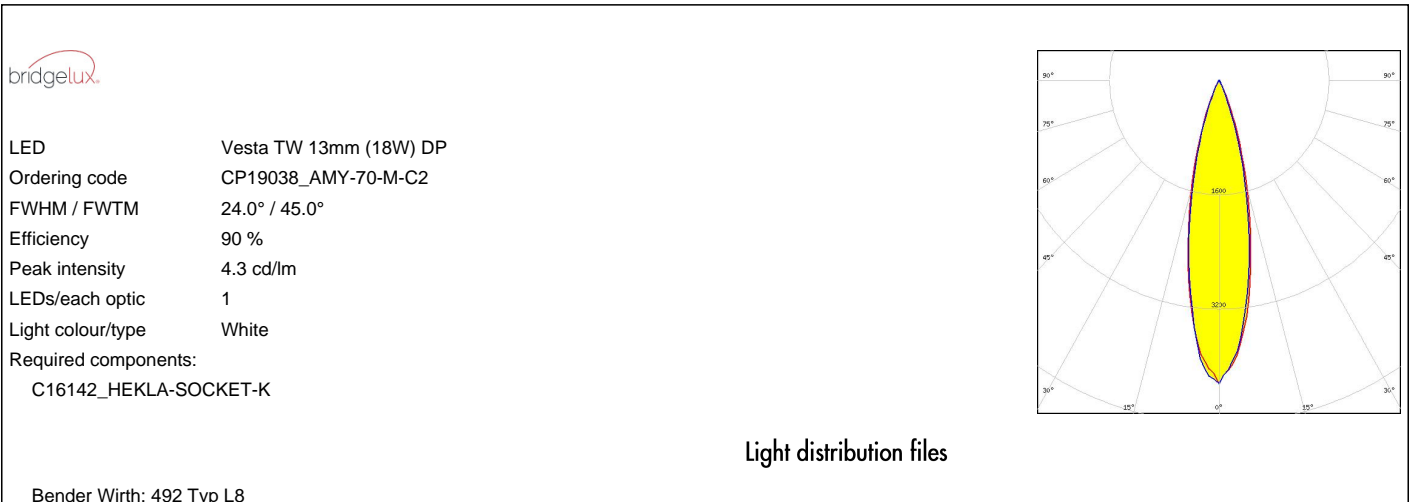

OPTICAL RESULTS (SIMULATED):

CITIZEN

LED CLL03x/CLU03x
Ordering code CP19038_AMY-70-M-C2
FWHM / FWTM 23.0° / 49.0°
Efficiency 89 %
Peak intensity 3.9 cd/lm
LEDs/each optic 1
Light colour/type White
Required components:
F15859_HEKLA-SOCKET-I

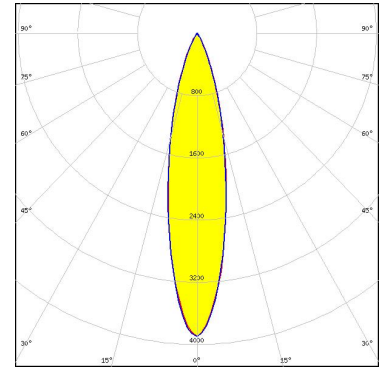

Light distribution files

CITIZEN

LED CLL04x/CLU04x
Ordering code CP19038_AMY-70-M-C2
FWHM / FWTM 33.0° / 66.0°
Efficiency 80 %
Peak intensity 1.9 cd/lm
LEDs/each optic 1
Light colour/type White
Required components:

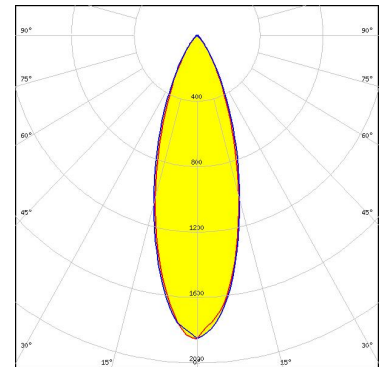

Bender Wirth: 631a Hekla XL

Light distribution files

CITIZEN

LED CLU03Q Type-F
Ordering code CP19038_AMY-70-M-C2
FWHM / FWTM 28.0° / 54.0°
Efficiency 92 %
Peak intensity 3.2 cd/lm
LEDs/each optic 1
Light colour/type White
Required components:
F17438_HEKLA-G2-I

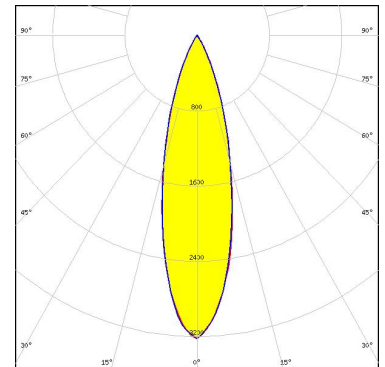

Light distribution files

OPTICAL RESULTS (SIMULATED):

CITIZEN

LED CLU700/701/702/703
Ordering code CP19038_AMY-70-M-C2
FWHM / FWTM 20.0° / 36.0°
Efficiency 92 %
Peak intensity 6.1 cd/lm
LEDs/each optic 1
Light colour/type White
Required components:
F15255_HEKLA-SOCKET-C

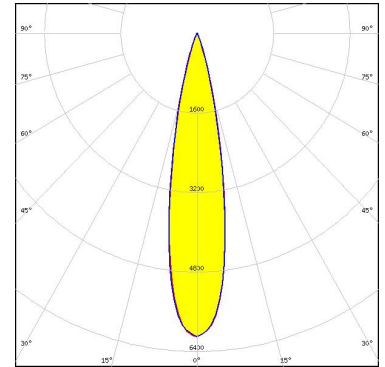

Light distribution files

CITIZEN

LED CLU700/701/702/703
Ordering code CP19038_AMY-70-M-C2
FWHM / FWTM 21.0° / 37.0°
Efficiency 93 %
Peak intensity 6.1 cd/lm
LEDs/each optic 1
Light colour/type White
Required components:
F15255_HEKLA-SOCKET-C

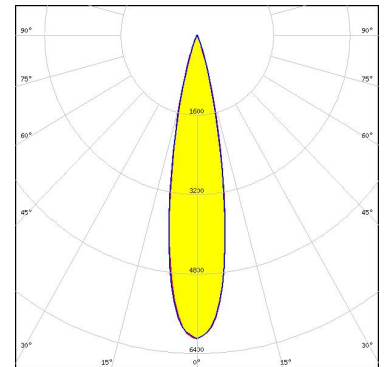

Light distribution files



LED CMA1825
Ordering code CP19038_AMY-70-M-C2
FWHM / FWTM 24.0° / 45.0°
Efficiency 90 %
Peak intensity 4.4 cd/lm
LEDs/each optic 1
Light colour/type White
Required components:
F15254_HEKLA-SOCKET-B

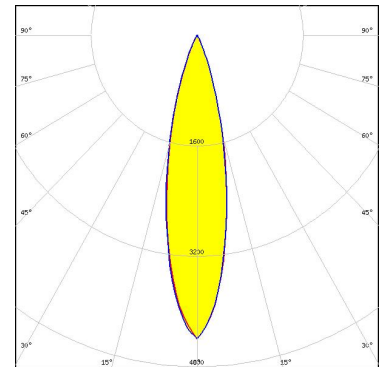

Light distribution files

OPTICAL RESULTS (SIMULATED):



LED CMT14xx
Ordering code CP19038_AMY-70-M-C2
FWHM / FWTM 22.0° / 39.0°
Efficiency 91 %
Peak intensity 5.7 cd/lm
LEDs/each optic 1
Light colour/type White
Required components:
 F17435_HEKLA-G2-C

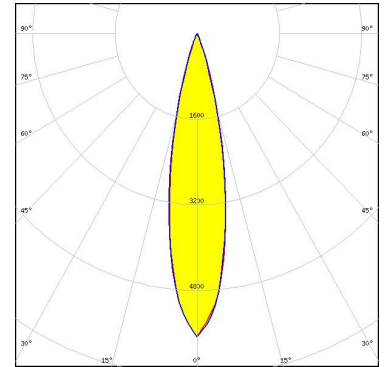

Light distribution files



LED CMT14xx
Ordering code C17777_AMY-70-M
FWHM / FWTM 22.0° / 38.0°
Efficiency 96 %
Peak intensity 5.9 cd/lm
LEDs/each optic 1
Light colour/type White
Required components:

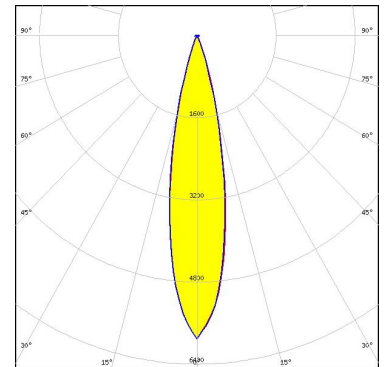

Light distribution files



LED CMU10xx
Ordering code CP19038_AMY-70-M-C2
FWHM / FWTM 22.0° / 40.0°
Efficiency 91 %
Peak intensity 5.5 cd/lm
LEDs/each optic 1
Light colour/type White
Required components:
 F17435_HEKLA-G2-C

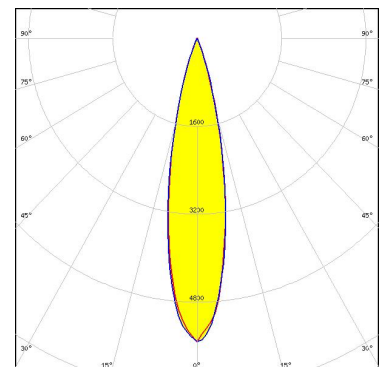

Light distribution files

OPTICAL RESULTS (SIMULATED):



LED CXA/B 15xx
Ordering code CP19038_AMY-70-M-C2
FWHM / FWTM 20.0° / 40.0°
Efficiency 91 %
Peak intensity 5.7 cd/lm
LEDs/each optic 1
Light colour/type White
Required components:
 F15256_HEKLA-SOCKET-D

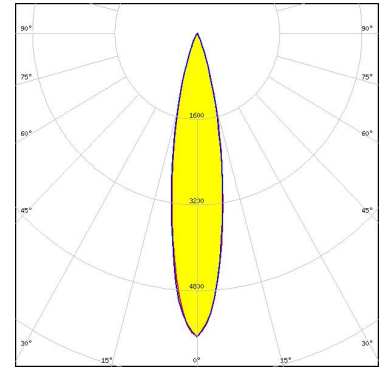

Light distribution files



LED LUXEON CX Plus CoB L08 (Gen2)
Ordering code CP19038_AMY-70-M-C2
FWHM / FWTM 26.0° / 49.0°
Efficiency 93 %
Peak intensity 3.9 cd/lm
LEDs/each optic 1
Light colour/type White
Required components:

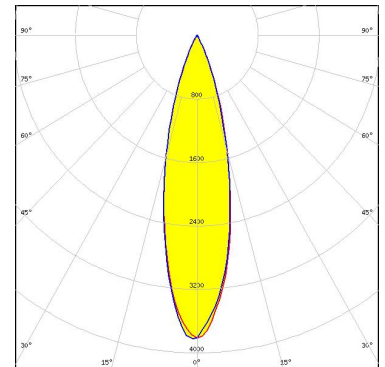

Bender Wirth: 637a Hekla

Light distribution files



LED LUXEON CoB 1202/1203
Ordering code CP19038_AMY-70-M-C2
FWHM / FWTM 22.0° / 38.0°
Efficiency 93 %
Peak intensity 6 cd/lm
LEDs/each optic 1
Light colour/type White
Required components:
 F15858_HEKLA-SOCKET-H

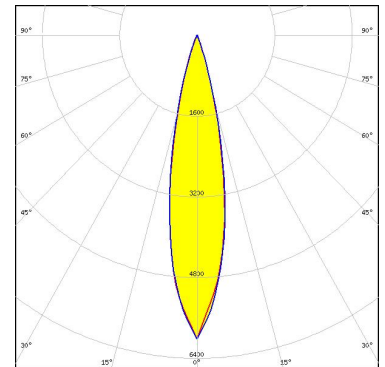

Light distribution files

OPTICAL RESULTS (SIMULATED):



LED LUXEON CoB 1202HD
Ordering code CP19038_AMY-70-M-C2
FWHM / FWTM 22.0° / 36.0°
Efficiency 94 %
Peak intensity 6.5 cd/lm
LEDs/each optic 1
Light colour/type White
Required components:
F15848_HEKLA-SOCKET-G

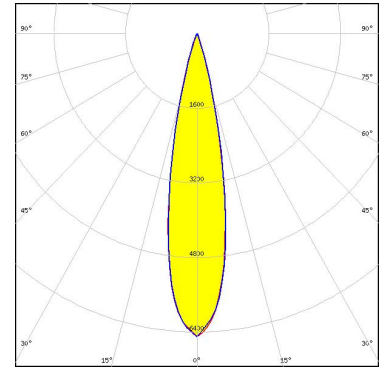

Light distribution files



LED LUXEON CoB 1204/1205
Ordering code CP19038_AMY-70-M-C2
FWHM / FWTM 25.0° / 46.0°
Efficiency 92 %
Peak intensity 4.3 cd/lm
LEDs/each optic 1
Light colour/type White
Required components:

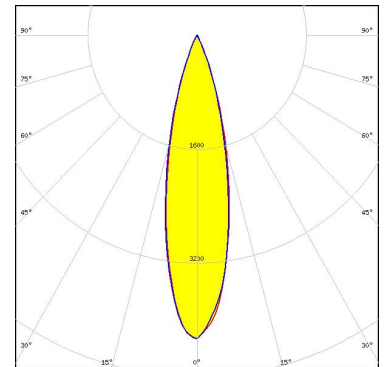

Bender Wirth: 632a Hekla XL

Light distribution files



LED LUXEON CoB 1204HD
Ordering code CP19038_AMY-70-M-C2
FWHM / FWTM 22.0° / 40.0°
Efficiency 93 %
Peak intensity 5.5 cd/lm
LEDs/each optic 1
Light colour/type White
Required components:
F15858_HEKLA-SOCKET-H

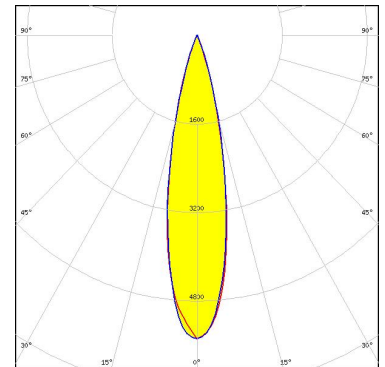

Light distribution files

OPTICAL RESULTS (SIMULATED):



LED LUXEON CoB 1205HD
Ordering code CP19038_AMY-70-M-C2
FWHM / FWTM 24.0° / 42.0°
Efficiency 92 %
Peak intensity 4.9 cd/lm
LEDs/each optic 1
Light colour/type White
Required components:
 F15858_HEKLA-SOCKET-H

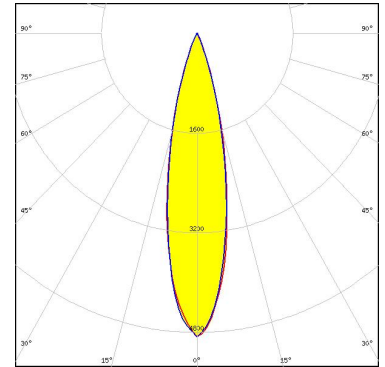

Light distribution files



LED LUXEON CoB 1208
Ordering code CP19038_AMY-70-M-C2
FWHM / FWTM 25.0° / 48.0°
Efficiency 92 %
Peak intensity 3.9 cd/lm
LEDs/each optic 1
Light colour/type White
Required components:

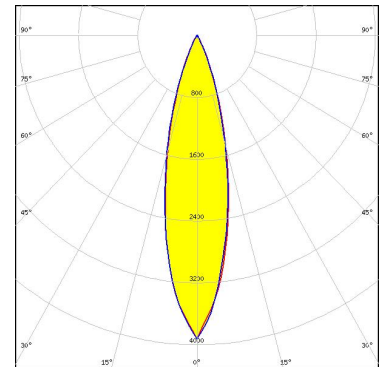

Bender Wirth: 632a Hekla XL

Light distribution files



LED LUXEON CX Plus CoB - HD S02H6
Ordering code CP19091_AMY-70-M-B2
FWHM / FWTM 22.0° / 35.0°
Efficiency 94 %
Peak intensity 6.6 cd/lm
LEDs/each optic 1
Light colour/type White
Required components:

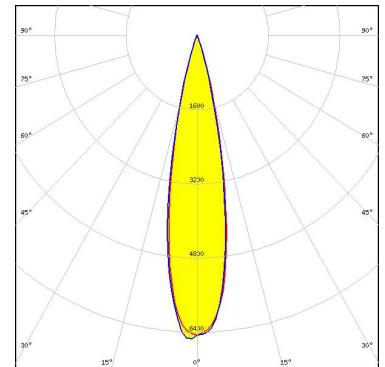

Bender Wirth: 634c Bayonet35L

Light distribution files

OPTICAL RESULTS (SIMULATED):



LED LUXEON CX Plus CoB - HD S04H9
Ordering code CP19038_AMY-70-M-C2
FWHM / FWTM 22.0° / 40.0°
Efficiency 91 %
Peak intensity 5.4 cd/lm
LEDs/each optic 1
Light colour/type White
Required components:
F15255_HEKLA-SOCKET-C

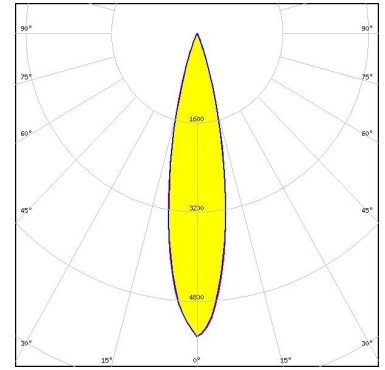

Light distribution files



LED LUXEON CX Plus CoB - HD S04H9
Ordering code CP19091_AMY-70-M-B2
FWHM / FWTM 22.0° / 40.0°
Efficiency 94 %
Peak intensity 5.6 cd/lm
LEDs/each optic 1
Light colour/type White
Required components:

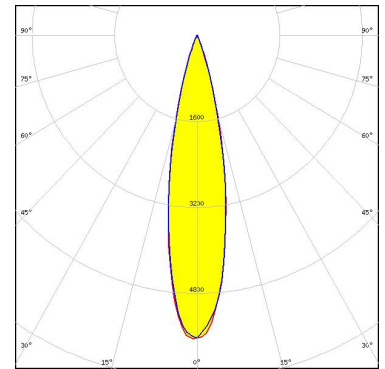

Bender Wirth: 634a Bayonet35L

Light distribution files



LED LUXEON CX Plus CoB - HD S04H9
Ordering code C17777_AMY-70-M
FWHM / FWTM 22.0° / 38.0°
Efficiency 96 %
Peak intensity 5.7 cd/lm
LEDs/each optic 1
Light colour/type White
Required components:

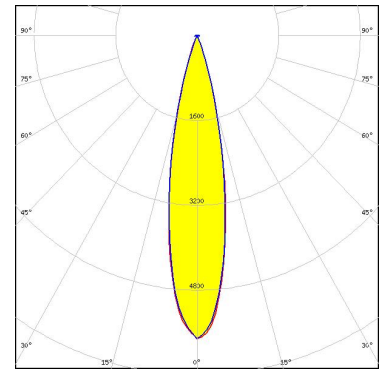

Light distribution files

OPTICAL RESULTS (SIMULATED):



LED LUXEON CX Plus CoB L04 / L05 (Gen2)
Ordering code CP19038_AMY-70-M-C2
FWHM / FWTM 24.0° / 44.0°
Efficiency 93 %
Peak intensity 4.6 cd/lm
LEDs/each optic 1
Light colour/type White
Required components:
 F15254_HEKLA-SOCKET-B

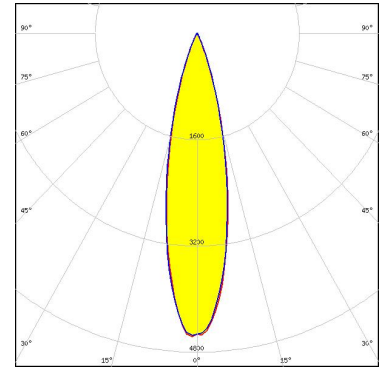

Light distribution files



LED LUXEON CX Plus CoB M02 / M03 (Gen2)
Ordering code CP19038_AMY-70-M-C2
FWHM / FWTM 22.0° / 38.0°
Efficiency 94 %
Peak intensity 5.8 cd/lm
LEDs/each optic 1
Light colour/type White
Required components:
 F15256_HEKLA-SOCKET-D

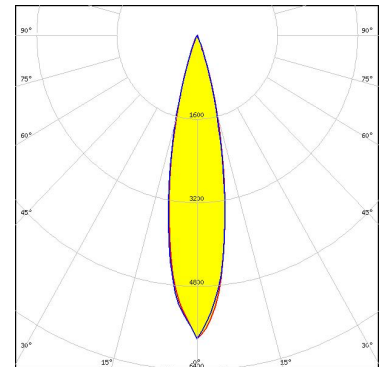

Light distribution files



LED LUXEON CX Plus CoB S01 (Gen2)
Ordering code CP19038_AMY-70-M-C2
FWHM / FWTM 22.0° / 35.0°
Efficiency 94 %
Peak intensity 6.6 cd/lm
LEDs/each optic 1
Light colour/type White
Required components:
 F15956_HEKLA-SOCKET-J

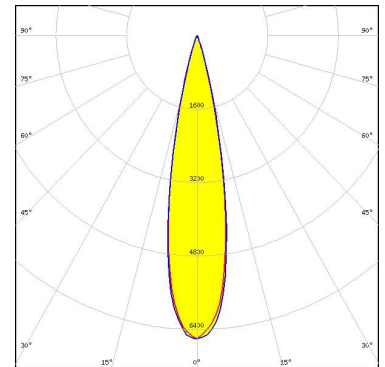

Light distribution files

OPTICAL RESULTS (SIMULATED):



LED CHM-9 XH (19x19)
Ordering code CP19038_AMY-70-M-C2
FWHM / FWTM 22.0° / 38.0°
Efficiency 94 %
Peak intensity 6 cd/lm
LEDs/each optic 1
Light colour/type White
Required components:
F15859_HEKLA-SOCKET-I

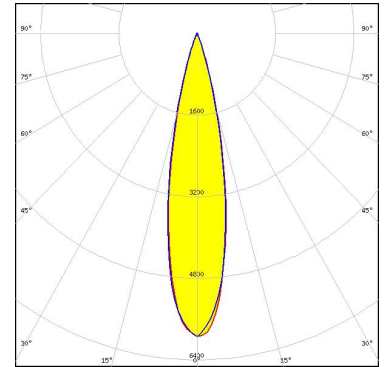

Light distribution files



LED CTM-6 (Tunable White) Gen2
Ordering code CP19038_AMY-70-M-C2
FWHM / FWTM 22.0° / 36.0°
Efficiency 94 %
Peak intensity 6.4 cd/lm
LEDs/each optic 1
Light colour/type Tunable White
Required components:
C16142_HEKLA-SOCKET-K

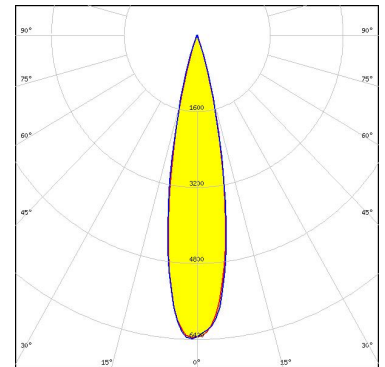

Light distribution files

Bender Wirth: 495 Typ L8



LED CTM-9 (Tunable White) Gen2
Ordering code CP19038_AMY-70-M-C2
FWHM / FWTM 22.0° / 38.0°
Efficiency 93 %
Peak intensity 5.9 cd/lm
LEDs/each optic 1
Light colour/type Tunable White
Required components:
C16142_HEKLA-SOCKET-K

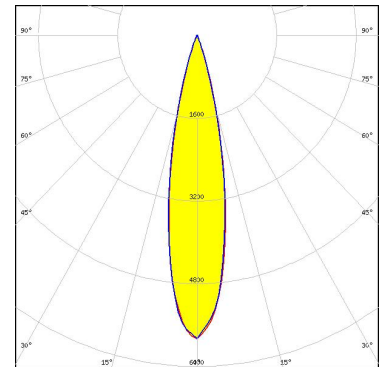

Light distribution files

Bender Wirth: 495 Typ L8

OPTICAL RESULTS (SIMULATED):



LED CXM-3
Ordering code CP19091_AMY-70-M-B2
FWHM / FWTM 20.0° / 32.0°
Efficiency 94 %
Peak intensity 7.4 cd/lm
LEDs/each optic 1
Light colour/type White
Required components:

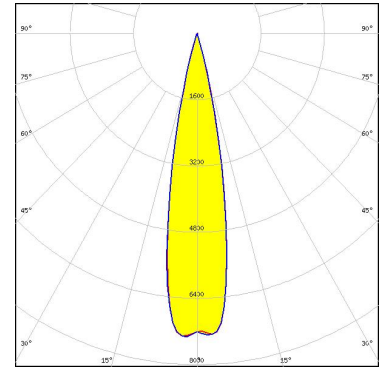

Bender Wirth: 634a Bayonet35L

Light distribution files



LED CXM-4
Ordering code CP19091_AMY-70-M-B2
FWHM / FWTM 21.0° / 32.0°
Efficiency 94 %
Peak intensity 7.2 cd/lm
LEDs/each optic 1
Light colour/type White
Required components:

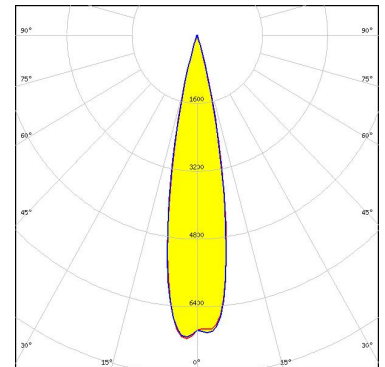

Bender Wirth: 634a Bayonet35L

Light distribution files



LED CxM-6 (13.5x13.5)
Ordering code CP19091_AMY-70-M-B2
FWHM / FWTM 22.0° / 34.0°
Efficiency 94 %
Peak intensity 6.7 cd/lm
LEDs/each optic 1
Light colour/type White
Required components:

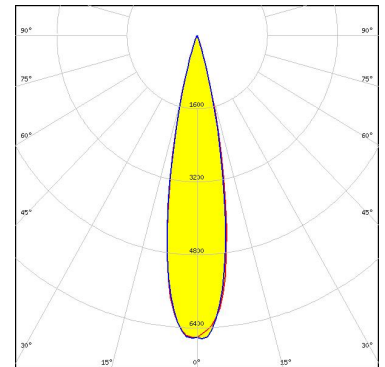

BJB: 47.360.1020

Light distribution files

OPTICAL RESULTS (SIMULATED):

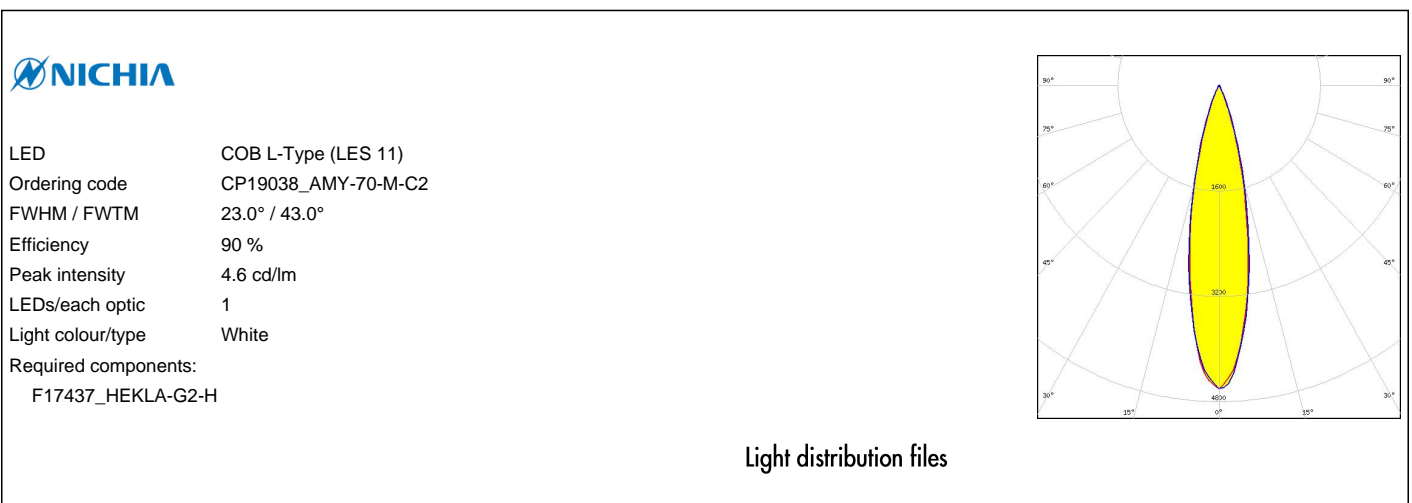
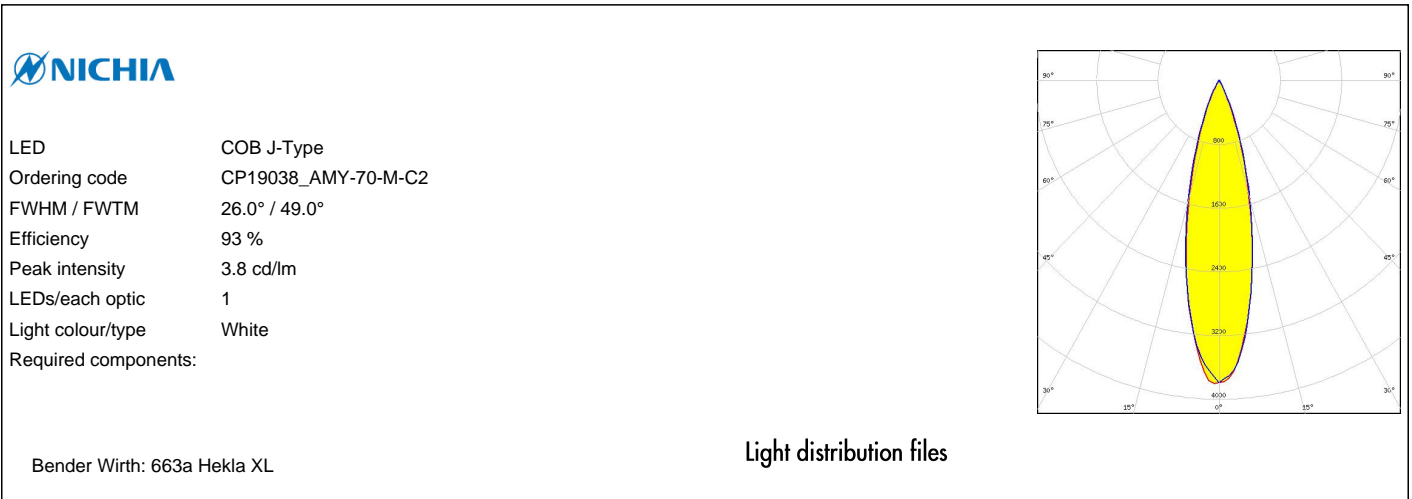

OPTICAL RESULTS (SIMULATED):

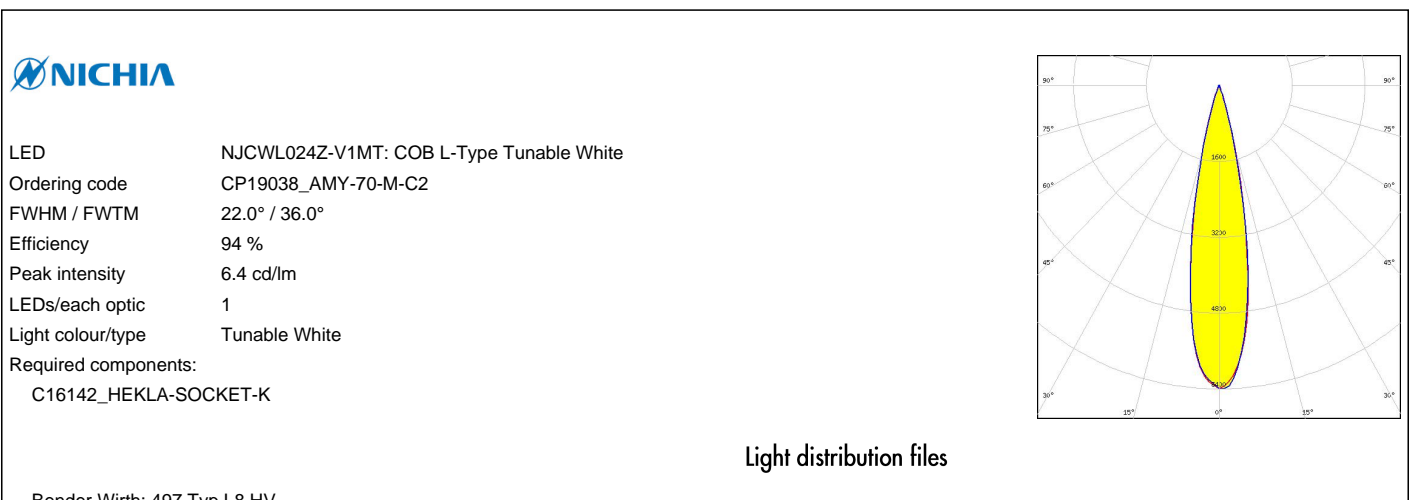
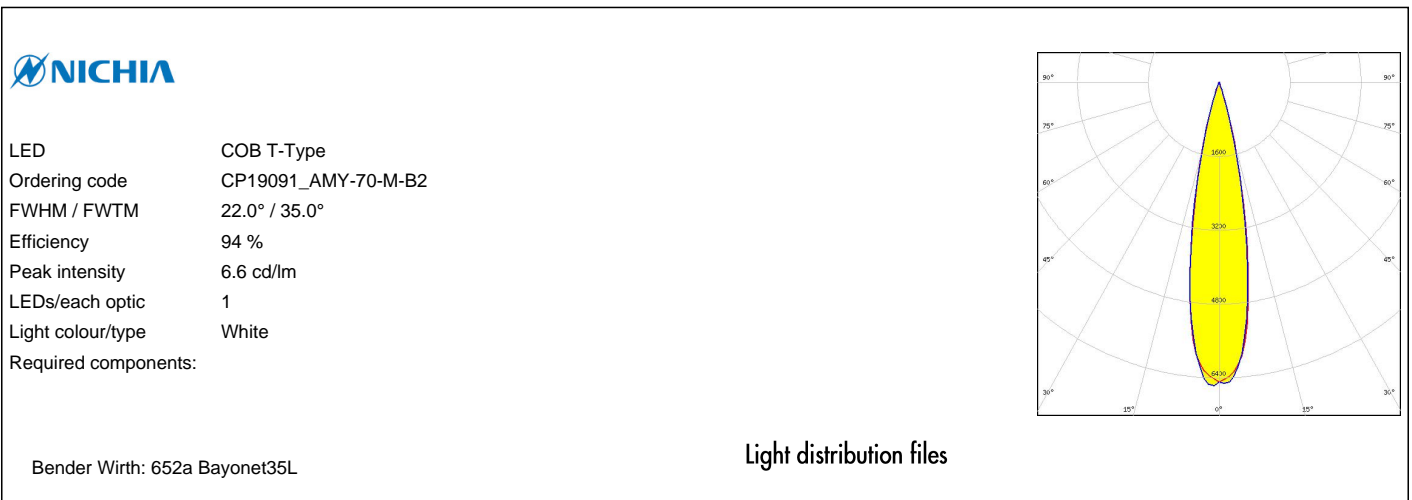
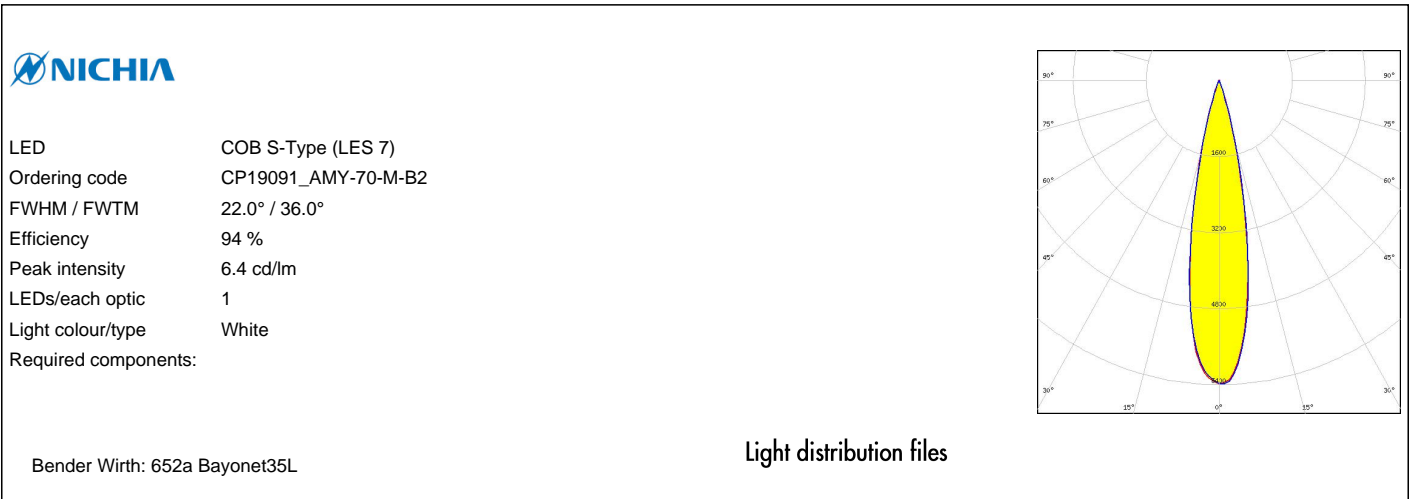

OPTICAL RESULTS (SIMULATED):



LED NJNWS012Z-V1MT: COB S-Type Tunable White
Ordering code CP19038_AMY-70-M-C2
FWHM / FWTM 22.0° / 34.0°
Efficiency 94 %
Peak intensity 6.8 cd/lm
LEDs/each optic 1
Light colour/type Tunable White
Required components:
C16142_HEKLA-SOCKET-K

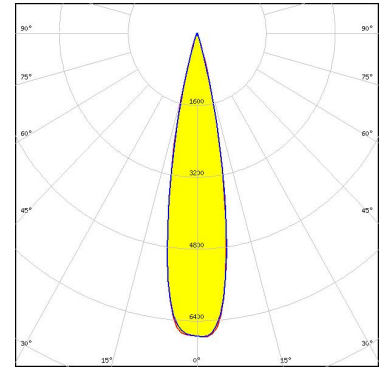

Light distribution files

Bender Wirth: 495 Typ L8 HV



LED NVCWJ024Z-V1MT: COB J-Type Tunable White
Ordering code CP19038_AMY-70-M-C2
FWHM / FWTM 22.0° / 41.0°
Efficiency 94 %
Peak intensity 5.2 cd/lm
LEDs/each optic 1
Light colour/type Tunable White
Required components:
C16142_HEKLA-SOCKET-K

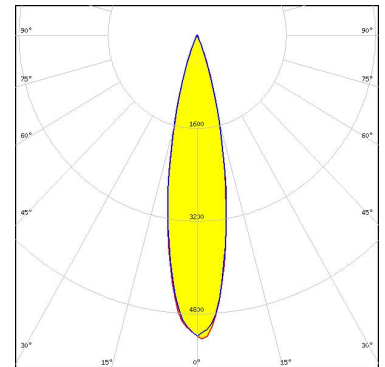

Light distribution files

Bender Wirth: 498 Typ L8 HV



LED Fortimo SLM L15 CoB
Ordering code CP19038_AMY-70-M-C2
FWHM / FWTM 26.0° / 48.0°
Efficiency 90 %
Peak intensity 3.8 cd/lm
LEDs/each optic 1
Light colour/type White
Required components:

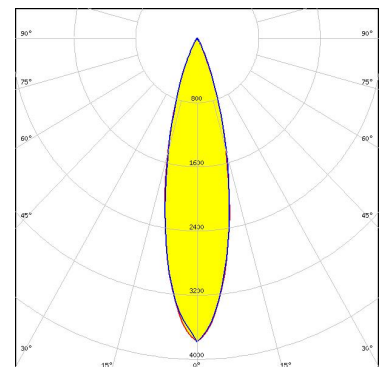

Light distribution files

Bender Wirth: 632a Hekla XL

OPTICAL RESULTS (SIMULATED):

SAMSUNG

LED LC003D / LC006D / LC009D / LC013D
Ordering code CP19038_AMY-70-M-C2
FWHM / FWTM 20.0° / 40.0°
Efficiency 92 %
Peak intensity 5.6 cd/lm
LEDs/each optic 1
Light colour/type White
Required components:
F15255_HEKLA-SOCKET-C

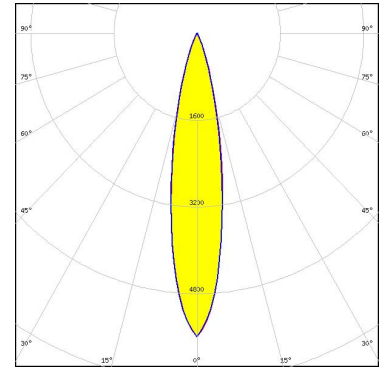

Light distribution files

SAMSUNG

LED LC010C G2
Ordering code CP19091_AMY-70-M-B2
FWHM / FWTM 22.0° / 34.0°
Efficiency 94 %
Peak intensity 6.8 cd/lm
LEDs/each optic 1
Light colour/type White
Required components:

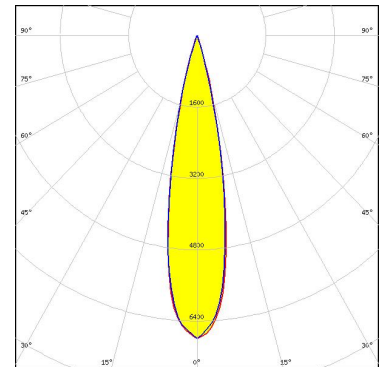

Light distribution files

BJB: 47.360.1020

SAMSUNG

LED LC010T (Tunable White)
Ordering code CP19038_AMY-70-M-C2
FWHM / FWTM 22.0° / 37.0°
Efficiency 94 %
Peak intensity 6.1 cd/lm
LEDs/each optic 1
Light colour/type Tunable White
Required components:

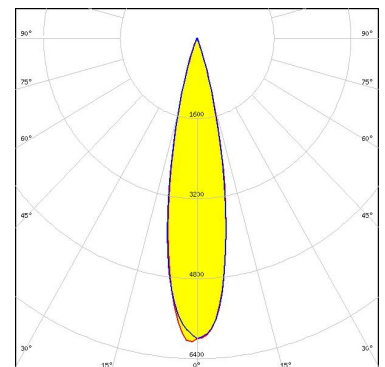

Light distribution files

Bender Wirth: 501 Typ L8

OPTICAL RESULTS (SIMULATED):

SAMSUNG

LED LC016D / LC019D / LC026D / LC033D
Ordering code CP19038_AMY-70-M-C2
FWHM / FWTM 24.0° / 52.0°
Efficiency 89 %
Peak intensity 3.5 cd/lm
LEDs/each optic 1
Light colour/type White
Required components:
F15859_HEKLA-SOCKET-I

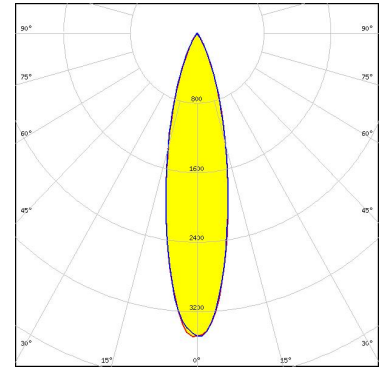

Light distribution files

SAMSUNG

LED LC020C G2
Ordering code CP19091_AMY-70-M-B2
FWHM / FWTM 22.0° / 38.0°
Efficiency 93 %
Peak intensity 5.9 cd/lm
LEDs/each optic 1
Light colour/type White
Required components:

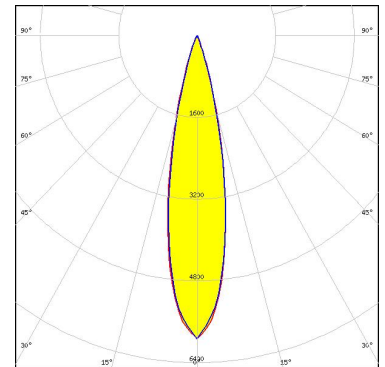

Light distribution files

BJB: 47.360.1010

SAMSUNG

LED LC020T (Tunable white)
Ordering code CP19038_AMY-70-M-C2
FWHM / FWTM 20.0° / 43.0°
Efficiency 91 %
Peak intensity 5.1 cd/lm
LEDs/each optic 1
Light colour/type White
Required components:
F15859_HEKLA-SOCKET-I

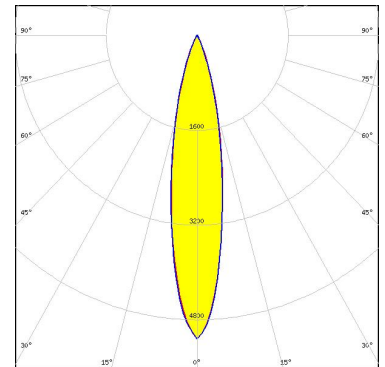

Light distribution files

OPTICAL RESULTS (SIMULATED):

SAMSUNG

LED LC020T (Tunable white)
Ordering code CP19038_AMY-70-M-C2
FWHM / FWTM 24.0° / 42.0°
Efficiency 94 %
Peak intensity 5 cd/lm
LEDs/each optic 1
Light colour/type Tunable White
Required components:
C16142_HEKLA-SOCKET-K

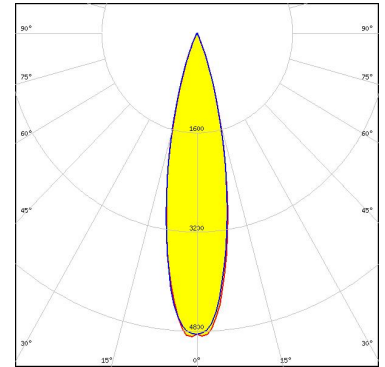

Light distribution files

Bender Wirth: 501 Typ L8

SAMSUNG

LED LC030C/040C G2
Ordering code CP19091_AMY-70-M-B2
FWHM / FWTM 24.0° / 44.0°
Efficiency 93 %
Peak intensity 4.8 cd/lm
LEDs/each optic 1
Light colour/type White
Required components:

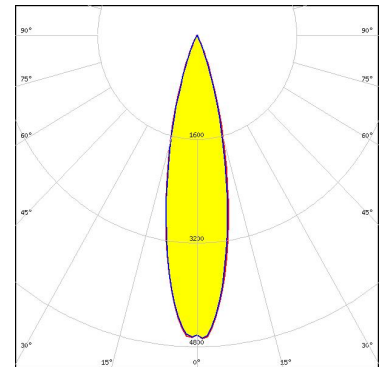

Light distribution files

BJB: 47.360.1010



LED MJT COB LES 14.5
Ordering code CP19038_AMY-70-M-C2
FWHM / FWTM 24.0° / 48.0°
Efficiency 93 %
Peak intensity 4.1 cd/lm
LEDs/each optic 1
Light colour/type White
Required components:
F15859_HEKLA-SOCKET-I

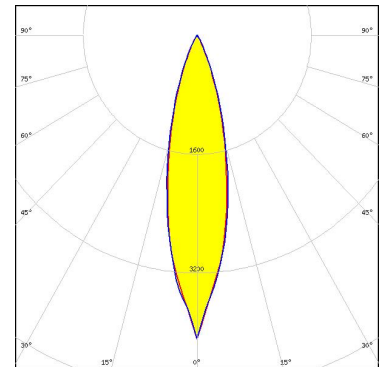

Light distribution files

OPTICAL RESULTS (SIMULATED):

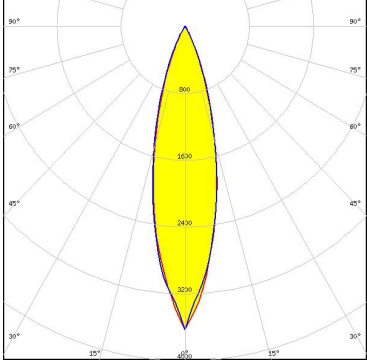
 <small>SEOUL SEMICONDUCTOR</small>		
LED	MJT COB LES 14.5	
Ordering code	CP19038_AMY-70-M-C2	
FWHM / FWTM	26.0° / 51.0°	
Efficiency	89 %	
Peak intensity	3.6 cd/lm	
LEDs/each optic	1	
Light colour/type	White	
Required components: F17438_HEKLA-G2-I		

Light distribution files

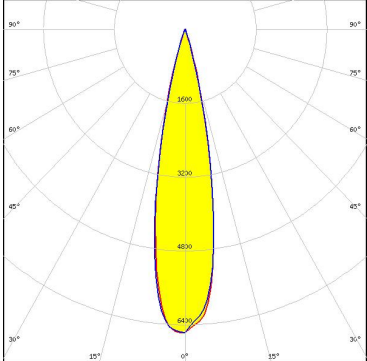
 <small>SEOUL SEMICONDUCTOR</small>		
LED	MJT COB LES 6	
Ordering code	CP19038_AMY-70-M-C2	
FWHM / FWTM	22.0° / 34.0°	
Efficiency	95 %	
Peak intensity	6.7 cd/lm	
LEDs/each optic	1	
Light colour/type	White	
Required components: F15255_HEKLA-SOCKET-C		

Light distribution files

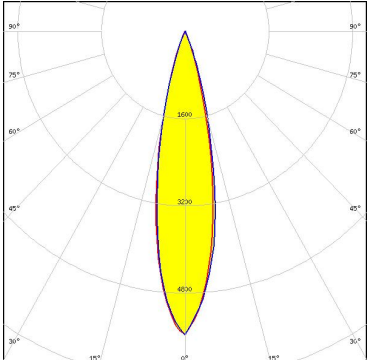
 <small>SEOUL SEMICONDUCTOR</small>		
LED	MJT COB LES 9.8	
Ordering code	CP19038_AMY-70-M-C2	
FWHM / FWTM	23.0° / 40.0°	
Efficiency	94 %	
Peak intensity	5.6 cd/lm	
LEDs/each optic	1	
Light colour/type	White	
Required components: F15255_HEKLA-SOCKET-C		

Light distribution files

OPTICAL RESULTS (SIMULATED):

TRIDONIC

LED SLE G7 LES13
Ordering code CP19038_AMY-70-M-C2
FWHM / FWTM 24.0° / 46.0°
Efficiency 92 %
Peak intensity 4.3 cd/lm
LEDs/each optic 1
Light colour/type White
Required components:
F17438_HEKLA-G2-I

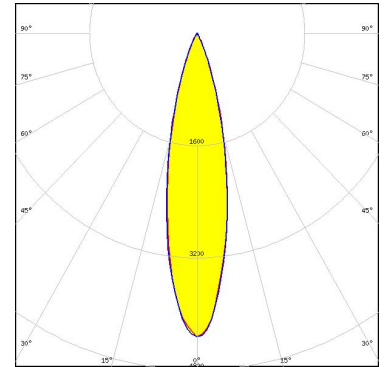

Light distribution files

XICATO

LED XOB 14.5 mm
Ordering code CP19038_AMY-70-M-C2
FWHM / FWTM 26.0° / 45.0°
Efficiency 82 %
Peak intensity 3.8 cd/lm
LEDs/each optic 1
Light colour/type White
Required components:
F17438_HEKLA-G2-I

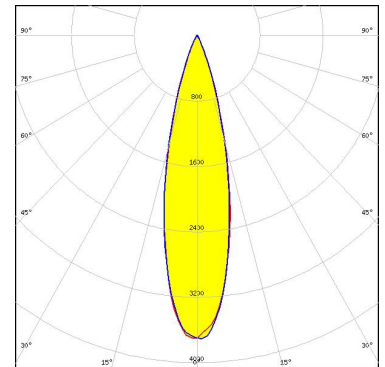

Light distribution files

GENERAL INFORMATION:

NOTE: The typical beam angle will be changed by different color, chip size and chip position tolerance. The typical total beam angle is the full angle measured where the luminous intensity is half of the peak value.

Due to use of high power COB's with this product, special attention to proper thermal design is highly recommended. LEDiL has no liability for direct, indirect or consecutive damages arising from the LEDiL products being used outside of the recommended temperature range.

MATERIALS:

As part of our continuous research and improvement processes, and to ensure the best possible quality and availability of our products, LEDiL reserves the right to change material grades without notice.

PRODUCT DATA USER AGREEMENT AND DISCLAIMER:

The measured data in the provided downloadable LEDiL Product Datasheets and Mechanical 2D-Drawings is rounded and provided as reference for planning. LEDiL Oy's optical specifications have been verified by conducting performance testing of the products in accordance with the company's quality system. The reported data are averaged results of multiple measurements with typical variation. LEDiL Oy reserves the right to without prior notification make changes and improvements to its products.

LEDiL Oy assumes neither warranty, nor guarantee nor any other liability of any kind for the contents and correctness of the provided data. The provided data has been generated with highest diligence but the provided data may in reality not represent the complete possible variation range of all intrinsic parameters. Therefore, in certain cases a deviation from the provided data could occur.

LEDiL Oy reserves the right to undertake technical changes of its products without further notification which could lead to changes in the provided data. LEDiL Oy assumes no liability of any kind for the possible deviation from any provided data or any other damage resulting from the usage of the provided data.

The user agrees to this disclaimer and user agreement with the download or usage of the provided files.

LEDiL Oy

Joensuunkatu 7
FI-24240 SALO
Finland

LEDiL Inc.

228 West Page Street
Suite D
Sycamore IL 60178
USA

Ledil Optics Technology (Shenzhen) Co., Ltd.

405 , Block B
Casic Motor Building
Shenzhen 518057
P.R.CHINA

Local sales and technical support

[www.ledil.com/
where_to_buy](http://www.ledil.com/where_to_buy)

Shipping locations

Poznan, Poland
Hong Kong, China

Distribution Partners

[www.ledil.com/
where_to_buy](http://www.ledil.com/where_to_buy)