

AMY-70-O

~25 + 60° oval beam

SPECIFICATION:

Dimensions	Ø 69.9
Height	13 mm
Fastening	socket
ROHS compliant	yes ⓘ

MATERIALS:

Component	Type	Material	Colour	Finish	Length (mm)
AMY-70-O	Single lens	PMMA	clear		
AMY-70-HLD2-C-ASYM	Holder C	PC	black		
AMY-70-HLD2-B-ASYM	Holder B	PC	black		
AMY-70-HLD2-C-WHT-ASYM	Holder C	PC	white		
AMY-70-HLD2-B-WHT-ASYM	Holder B	PC	white		
AMY-70-HLD2-B50-ASYM	Holder B	PC	black		
AMY-70-HLD2-B50-WHT-ASYM	Holder B	PC	white		



ORDERING INFORMATION:

Component	Qty in box	MOQ	MPQ	Box weight (kg)
C18466_AMY-70-O	285	285	15	9.8
Assembly				
CP19655_AMY-70-O-B50-WHT	210	210	15	8.9
CP19647_AMY-70-O-B50	210	210	15	8.9
CP19120_AMY-70-O-B2-WHT	210	210	15	9.1
CP19111_AMY-70-O-C2-WHT	210	210	15	8.9
CP19104_AMY-70-O-B2	210	210	15	9.1
CP19044_AMY-70-O-C2	210	210	15	8.9

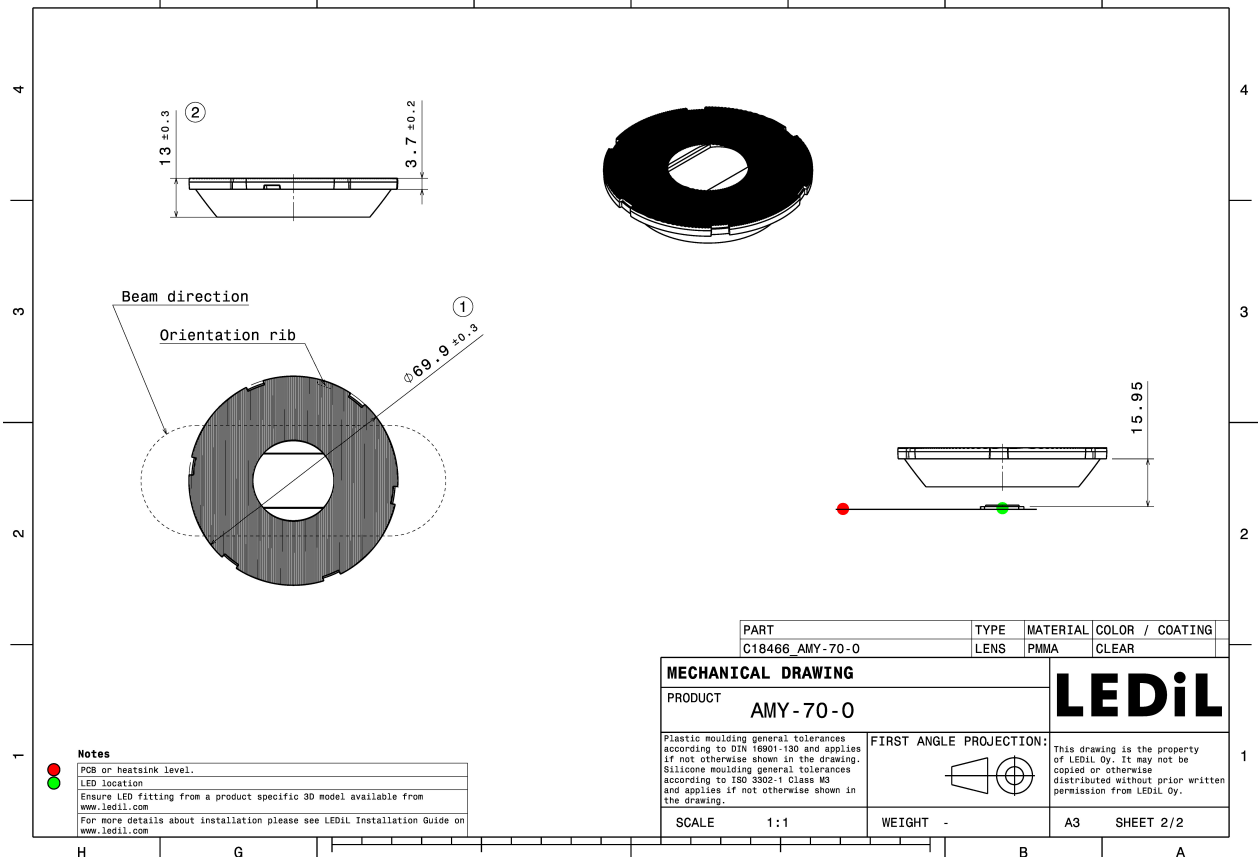
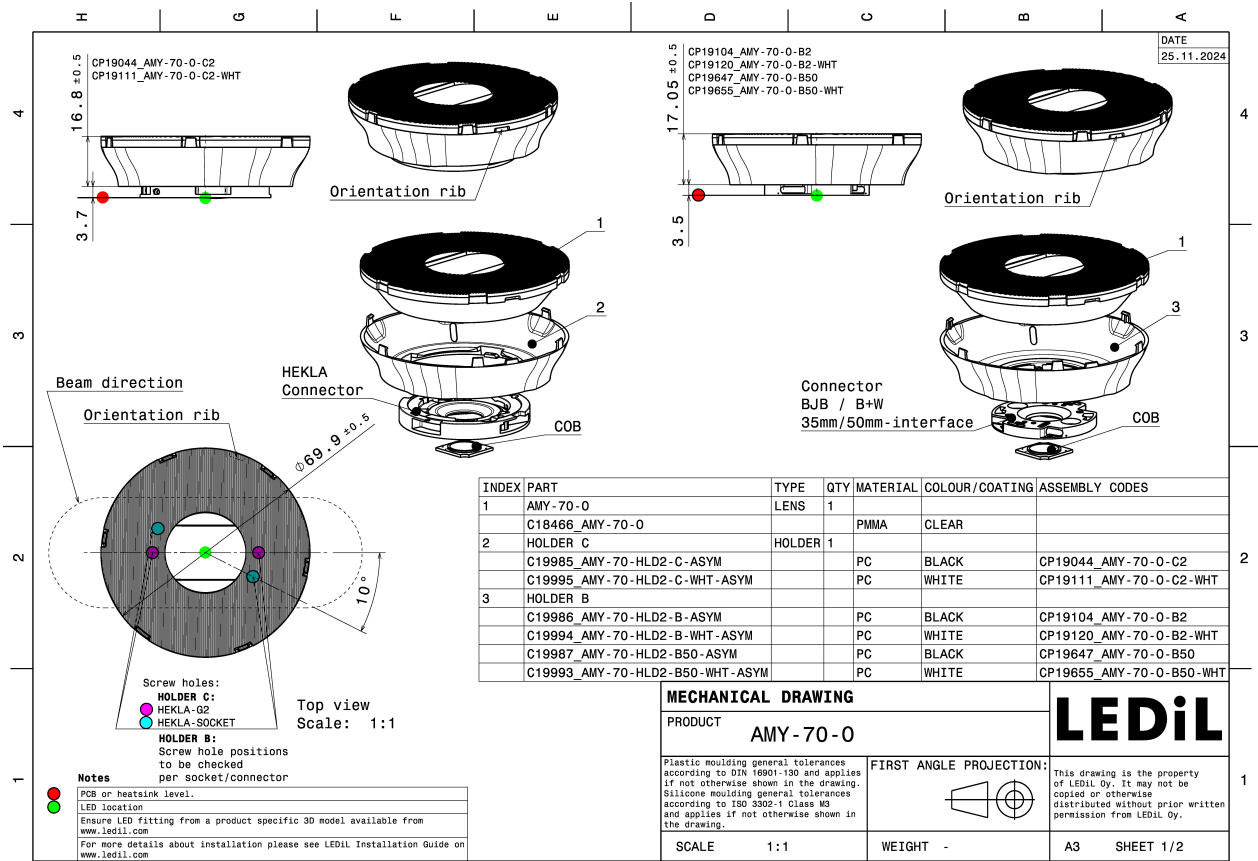

See also our general installation guide: www.ledil.com/installation_guide

OPTICAL RESULTS (MEASURED):



LED V13 Gen 8-9
Ordering code CP19044_AMY-70-O-C2
FWHM / FWTM 60.0 + 23.0° / 96.0 + 53.0°
Efficiency 85 %
LEDs/each optic 1
Light colour/type White
Required components:
 F15859_HEKLA-SOCKET-I

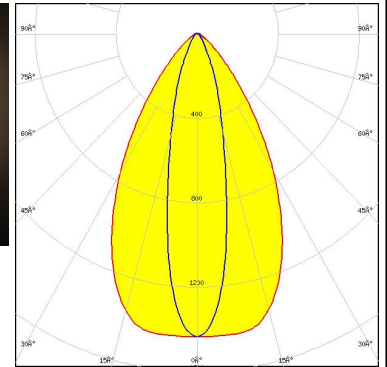

Light distribution files



LED V9 HD Gen7
Ordering code CP19044_AMY-70-O-C2
FWHM / FWTM 15.0 + 62.0° / 38.0 + 93.0°
Efficiency 87 %
LEDs/each optic 1
Light colour/type White
Required components:
 F15859_HEKLA-SOCKET-I

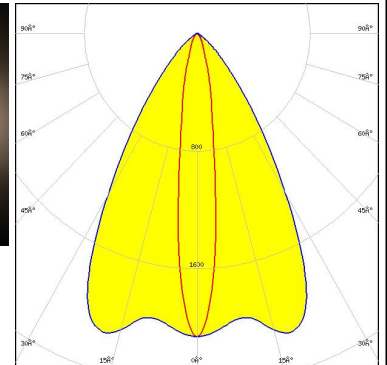
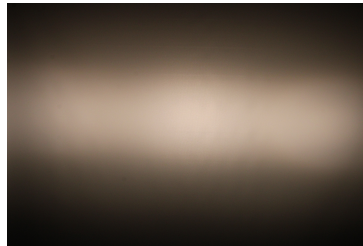

Light distribution files

CITIZEN

LED CLL03x/CLU03x
Ordering code CP19044_AMY-70-O-C2
FWHM / FWTM 23.0 + 63.0° / 52.0 + 97.0°
Efficiency 86 %
LEDs/each optic 1
Light colour/type White
Required components:
 F17438_HEKLA-G2-I

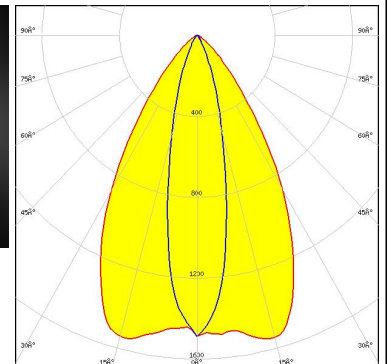
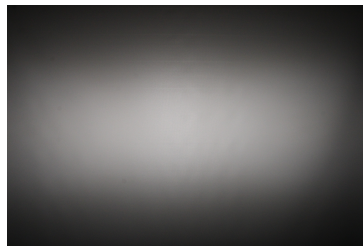

Light distribution files

OPTICAL RESULTS (MEASURED):

CITIZEN

LED CLU712/713
Ordering code CP19044_AMY-70-O-C2
FWHM / FWTM 64.0 + 15.0° / 94.0 + 38.0°
Efficiency 87 %
LEDs/each optic 1
Light colour/type White
Required components:
F17438_HEKLA-G2-I

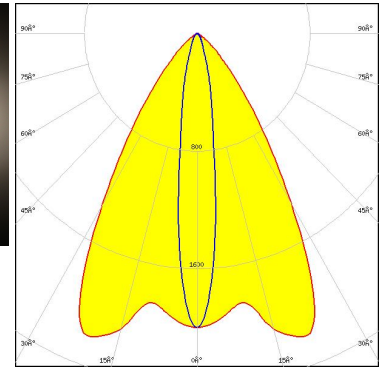
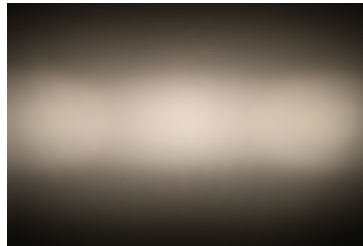

Light distribution files

CITIZEN

LED CLU720/721/723
Ordering code CP19044_AMY-70-O-C2
FWHM / FWTM 63.0 + 18.0° / 94.0 + 43.0°
Efficiency 83 %
LEDs/each optic 1
Light colour/type White
Required components:
F17438_HEKLA-G2-I

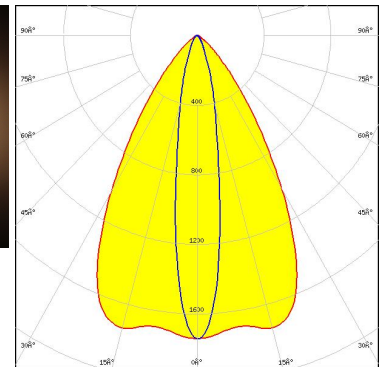
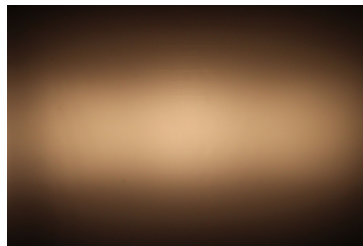

Light distribution files



LED CMA1825
Ordering code CP19044_AMY-70-O-C2
FWHM / FWTM 65.0 + 20.0° / 97.0 + 47.0°
Efficiency 87 %
LEDs/each optic 1
Light colour/type White
Required components:
F15254_HEKLA-SOCKET-B

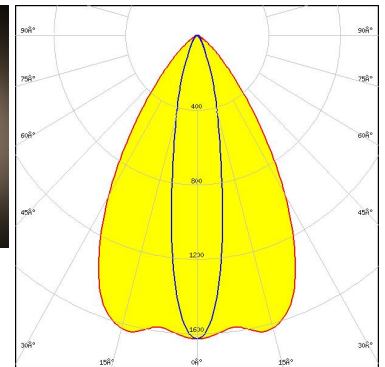
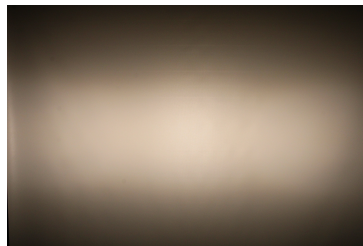

Light distribution files

OPTICAL RESULTS (MEASURED):



LED CMT19xx
Ordering code CP19044_AMY-70-O-C2
FWHM / FWTM 63.0 + 23.0° / 97.0 + 52.0°
Efficiency 86 %
LEDs/each optic 1
Light colour/type White
Required components:
 F17438_HEKLA-G2-I

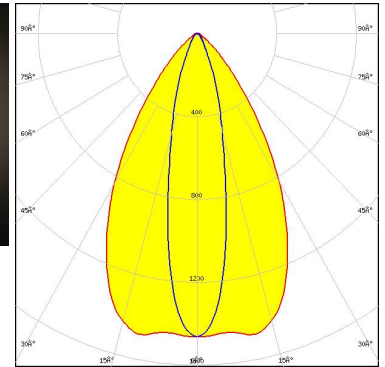
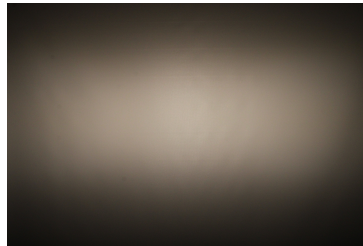

Light distribution files



LED LUXEON CoB 1204HD
Ordering code CP19044_AMY-70-O-C2
FWHM / FWTM 63.0 + 15.0° / 93.0 + 39.0°
Efficiency 85 %
LEDs/each optic 1
Light colour/type White
Required components:
 F17437_HEKLA-G2-H

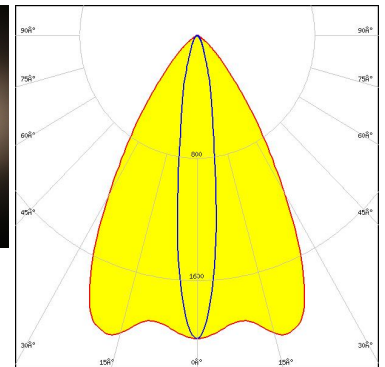
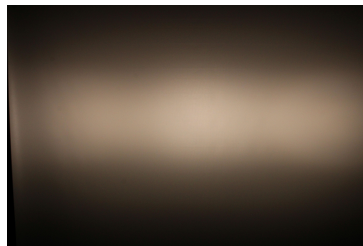

Light distribution files



LED LUXEON CoB 1205HD
Ordering code CP19044_AMY-70-O-C2
FWHM / FWTM 62.0 + 18.0° / 94.0 + 44.0°
Efficiency 85 %
LEDs/each optic 1
Light colour/type White
Required components:
 F17437_HEKLA-G2-H

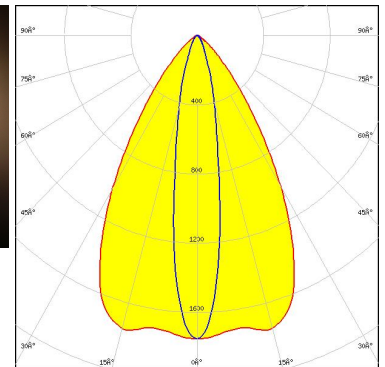
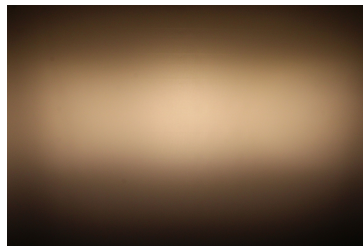

Light distribution files

OPTICAL RESULTS (MEASURED):



LED CTM-14 (Tunable White) Gen2
Ordering code CP19044_AMY-70-O-C2
FWHM / FWTM 22.0 + 61.0° / 51.0 + 95.0°
Efficiency 85 %
LEDs/each optic 1
Light colour/type White
Required components:
C16142_HEKLA-SOCKET-K
Bender Wirth: 442 Typ L8

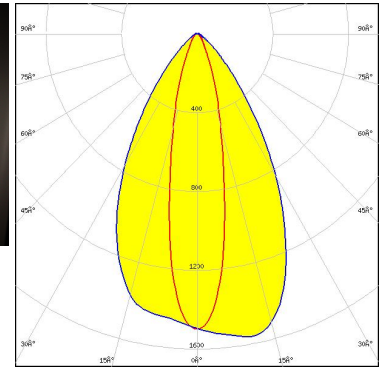
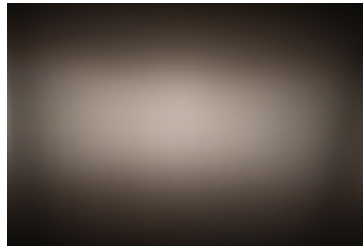

Light distribution files



LED LC003D / LC006D / LC009D / LC013D
Ordering code CP19044_AMY-70-O-C2
FWHM / FWTM 63.0 + 16.0° / 93.0 + 40.0°
Efficiency 86 %
LEDs/each optic 1
Light colour/type White
Required components:
F17435_HEKLA-G2-C

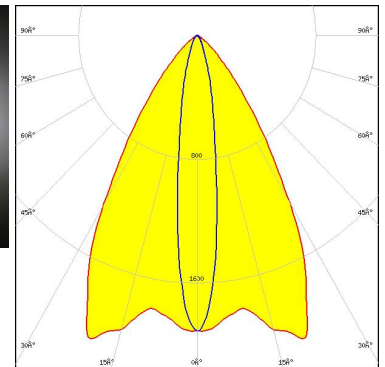
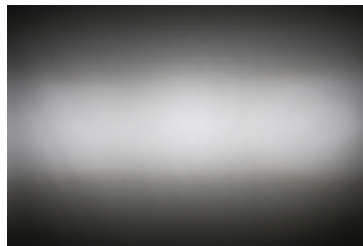

Light distribution files



LED LC016D / LC019D / LC026D / LC033D
Ordering code CP19044_AMY-70-O-C2
FWHM / FWTM 62.0 + 24.0° / 98.0 + 54.0°
Efficiency 85 %
LEDs/each optic 1
Light colour/type White
Required components:
F17438_HEKLA-G2-I

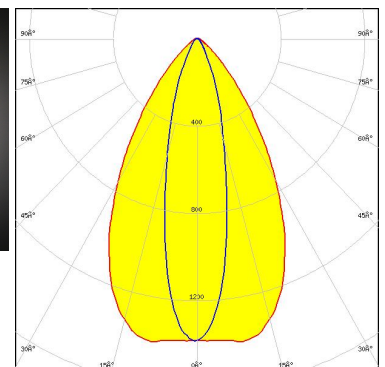
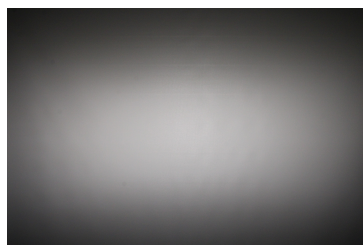

Light distribution files

OPTICAL RESULTS (SIMULATED):



LED V10 Gen 8-9
Ordering code CP19104_AMY-70-O-B2
FWHM / FWTM 62.0 + 16.0° / 91.0 + 37.0°
Efficiency 89 %
Peak intensity 2.3 cd/lm
LEDs/each optic 1
Light colour/type White
Required components:

BJB: 47.360.1020

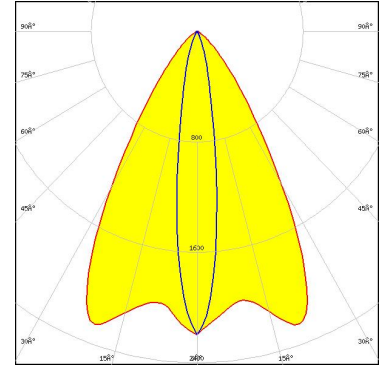

Light distribution files



LED V10 Gen 8-9
Ordering code CP19044_AMY-70-O-C2
FWHM / FWTM 62.0 + 16.0° / 94.0 + 37.0°
Efficiency 88 %
Peak intensity 2.2 cd/lm
LEDs/each optic 1
Light colour/type White
Required components:
 F15255_HEKLA-SOCKET-C

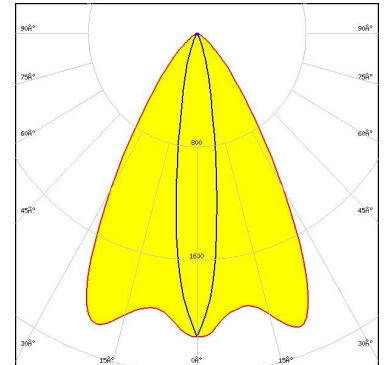

Light distribution files



LED V6 HD Gen 8
Ordering code CP19044_AMY-70-O-C2
FWHM / FWTM 13.0 + 23.0° / 31.0 + 57.0°
Efficiency 91 %
Peak intensity 3 cd/lm
LEDs/each optic 1
Light colour/type White
Required components:

Bender Wirth: 634c Hekla

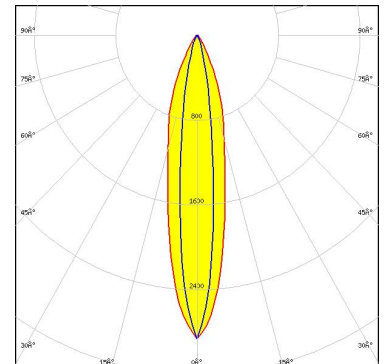

Light distribution files

OPTICAL RESULTS (SIMULATED):



LED Vesta SE 13mm TW
Ordering code CP19044_AMY-70-O-C2
FWHM / FWTM 62.0 + 20.0° / 92.0 + 42.0°
Efficiency 84 %
Peak intensity 1.7 cd/lm
LEDs/each optic 1
Light colour/type Tunable White
Required components:
C16142_HEKLA-SOCKET-K

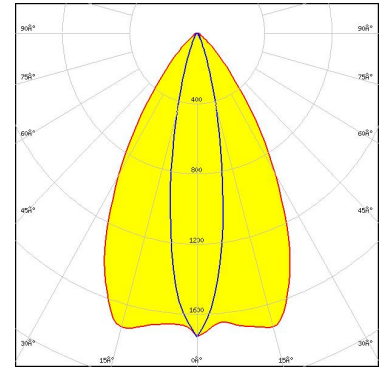

Light distribution files

CITIZEN

LED CLL02x/CLU02x (LES10)
Ordering code CP19044_AMY-70-O-C2
FWHM / FWTM 62.0 + 16.0° / 92.0 + 36.0°
Efficiency 86 %
Peak intensity 2.3 cd/lm
LEDs/each optic 1
Light colour/type White
Required components:
F17435_HEKLA-G2-C

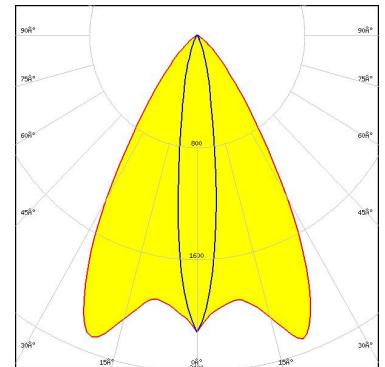

Light distribution files

CITIZEN

LED CLL02x/CLU02x (LES10)
Ordering code CP19104_AMY-70-O-B2
FWHM / FWTM 62.0 + 16.0° / 92.0 + 36.0°
Efficiency 89 %
Peak intensity 2.3 cd/lm
LEDs/each optic 1
Light colour/type White
Required components:

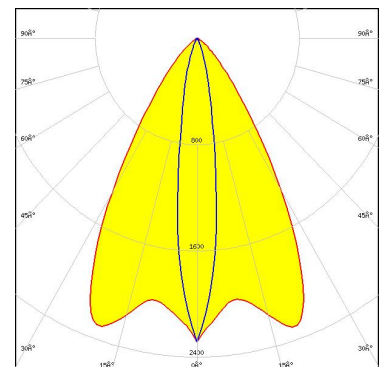

Light distribution files

BJB: 47.360.1020

OPTICAL RESULTS (SIMULATED):

CITIZEN

LED CLL02x/CLU02x (LES10)
Ordering code C18466_AMY-70-O
FWHM / FWTM 62.0 + 14.0° / 90.0 + 35.0°
Efficiency 94 %
Peak intensity 2.4 cd/lm
LEDs/each optic 1
Light colour/type White
Required components:

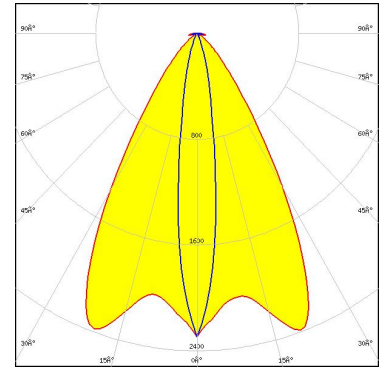

Light distribution files

CITIZEN

LED CLL03x/CLU03x
Ordering code CP19104_AMY-70-O-B2
FWHM / FWTM 62.0 + 22.0° / 94.0 + 48.0°
Efficiency 87 %
Peak intensity 1.7 cd/lm
LEDs/each optic 1
Light colour/type White
Required components:

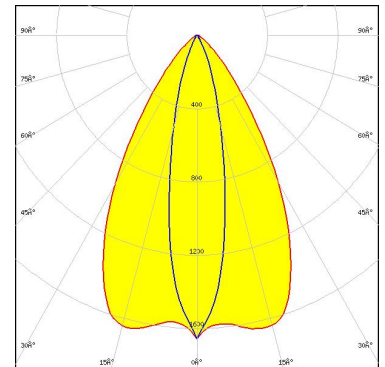

Light distribution files

BJB: 47.360.1010

CITIZEN

LED CLL03x/CLU03x
Ordering code C18466_AMY-70-O
FWHM / FWTM 64.0 + 22.0° / 94.0 + 48.0°
Efficiency 93 %
Peak intensity 1.6 cd/lm
LEDs/each optic 1
Light colour/type White
Required components:

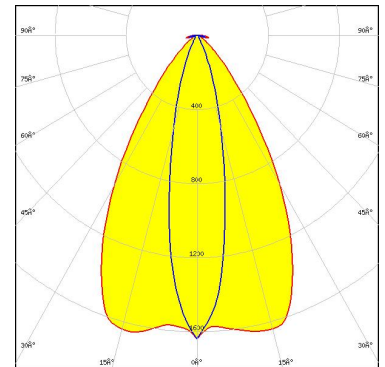

Light distribution files

OPTICAL RESULTS (SIMULATED):

CITIZEN

LED CLL03x/CLU03x
Ordering code CP19044_AMY-70-O-C2
FWHM / FWTM 64.0 + 23.0° / 96.0 + 50.0°
Efficiency 84 %
Peak intensity 1.5 cd/lm
LEDs/each optic 1
Light colour/type White
Required components:
F17438_HEKLA-G2-I

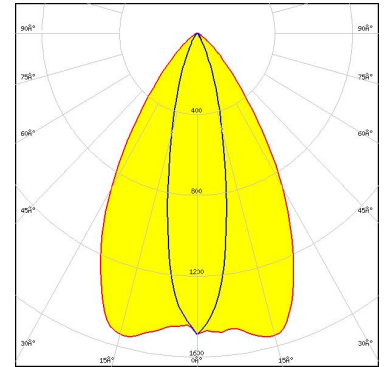

Light distribution files



LED CMU10xx
Ordering code CP19104_AMY-70-O-B2
FWHM / FWTM 62.0 + 16.0° / 91.0 + 36.0°
Efficiency 89 %
Peak intensity 2.3 cd/lm
LEDs/each optic 1
Light colour/type White
Required components:

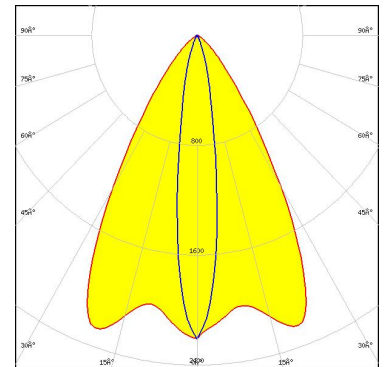

BJB: 47.360.1020

Light distribution files



LED CMU15xx
FWHM / FWTM 62.0 + 22.0° / 95.0 + 48.0°
Efficiency 93 %
Peak intensity 1.7 cd/lm
LEDs/each optic 1
Light colour/type White
Required components:
F17438_HEKLA-G2-I

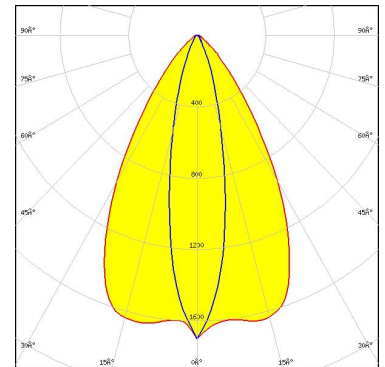

Light distribution files

OPTICAL RESULTS (SIMULATED):

LUMILEDS

LED: LUXEON CX Plus CoB L08 (Gen2)
 Ordering code: CP19044_AMY-70-O-C2
 FWHM / FWTM: 62.0 + 22.0° / 94.0 + 47.0°
 Efficiency: 90 %
 Peak intensity: 1.7 cd/lm
 LEDs/each optic: 1
 Light colour/type: White
 Required components:

Bender Wirth: 637a Hekla

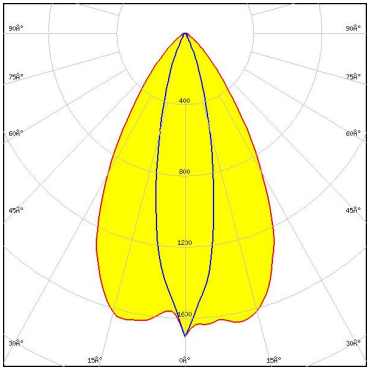

Light distribution files

LUMILEDS

LED: LUXEON CX Plus CoB - HD S02H6
 Ordering code: CP19104_AMY-70-O-B2
 FWHM / FWTM: 62.0 + 13.0° / 93.0 + 30.0°
 Efficiency: 91 %
 Peak intensity: 2.8 cd/lm
 LEDs/each optic: 1
 Light colour/type: White
 Required components:

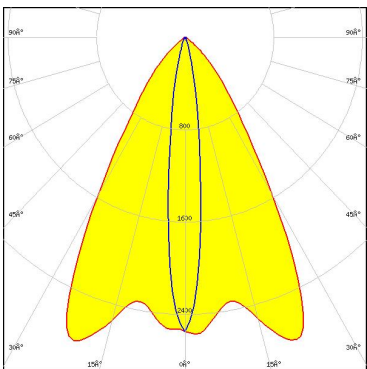

Light distribution files

LUMILEDS

LED: LUXEON CX Plus CoB - HD S04H9
 Ordering code: CP19104_AMY-70-O-B2
 FWHM / FWTM: 64.0 + 16.0° / 94.0 + 36.0°
 Efficiency: 91 %
 Peak intensity: 2.2 cd/lm
 LEDs/each optic: 1
 Light colour/type: White
 Required components:

Bender Wirth: 634a Bayonet35L

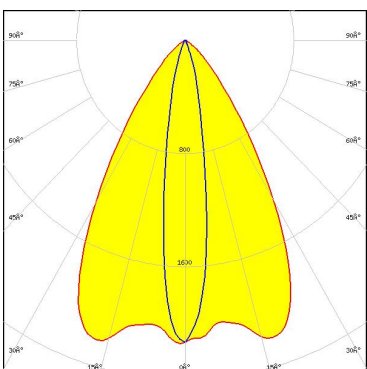

Light distribution files

OPTICAL RESULTS (SIMULATED):



LED LUXEON CX Plus CoB L04 / L05 (Gen2)
Ordering code CP19129_AMY-50-O-C2
FWHM / FWTM 52.0 + 23.0° / 86.0 + 50.0°
Efficiency 87 %
Peak intensity 1.8 cd/lm
LEDs/each optic 1
Light colour/type White
Required components:
F15254_HEKLA-SOCKET-B

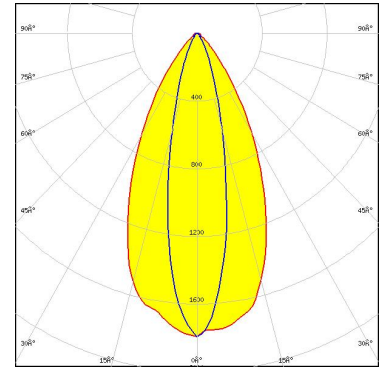

Light distribution files



LED LUXEON CX Plus CoB M02 / M03 (Gen2)
Ordering code CP19044_AMY-70-O-C2
FWHM / FWTM 62.0 + 16.0° / 93.0 + 35.0°
Efficiency 91 %
Peak intensity 2.3 cd/lm
LEDs/each optic 1
Light colour/type White
Required components:
F15256_HEKLA-SOCKET-D

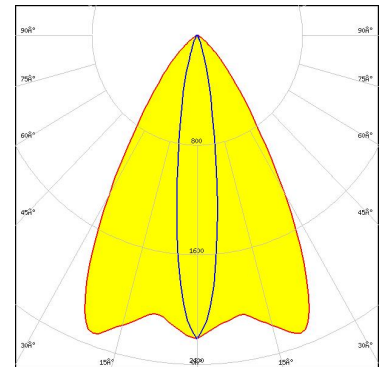

Light distribution files



LED LUXEON CX Plus CoB S01 (Gen2)
Ordering code CP19044_AMY-70-O-C2
FWHM / FWTM 61.0 + 12.0° / 92.0 + 29.0°
Efficiency 92 %
Peak intensity 3 cd/lm
LEDs/each optic 1
Light colour/type White
Required components:
F15956_HEKLA-SOCKET-J

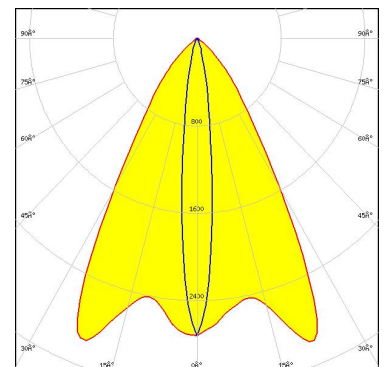

Light distribution files

OPTICAL RESULTS (SIMULATED):



LED CHM-11 XH (19x19)
Ordering code CP19044_AMY-70-O-C2
FWHM / FWTM 62.0 + 14.0° / 92.0 + 34.0°
Efficiency 92 %
Peak intensity 2.6 cd/lm
LEDs/each optic 1
Light colour/type White
Required components:
F15859_HEKLA-SOCKET-I

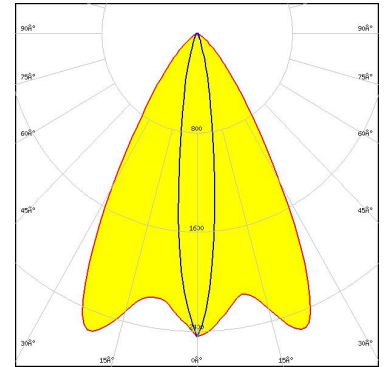

Light distribution files



LED CTM-14 (Tunable White) Gen2
Ordering code CP19044_AMY-70-O-C2
FWHM / FWTM 64.0 + 22.0° / 94.0 + 46.0°
Efficiency 90 %
Peak intensity 1.8 cd/lm
LEDs/each optic 1
Light colour/type Tunable White
Required components:
C16142_HEKLA-SOCKET-K

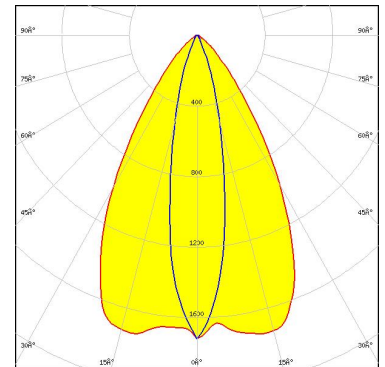

Light distribution files

Bender Wirth: 442 Typ L8



LED CTM-6 (Tunable White) Gen2
Ordering code CP19044_AMY-70-O-C2
FWHM / FWTM 60.0 + 12.0° / 90.0 + 30.0°
Efficiency 92 %
Peak intensity 3 cd/lm
LEDs/each optic 1
Light colour/type Tunable White
Required components:
C16142_HEKLA-SOCKET-K

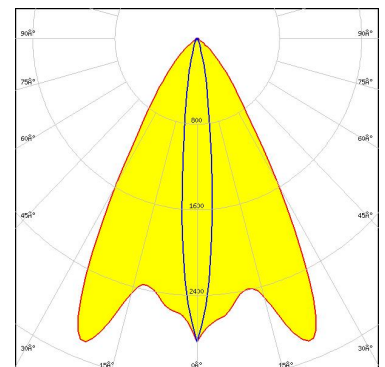

Light distribution files

Bender Wirth: 495 Typ L8

OPTICAL RESULTS (SIMULATED):

LUMINUS

LED: CTM-9 (Tunable White) Gen2
 Ordering code: CP19044_AMY-70-O-C2
 FWHM / FWTM: 62.0 + 15.0° / 90.0 + 34.0°
 Efficiency: 91 %
 Peak intensity: 2.5 cd/lm
 LEDs/each optic: 1
 Light colour/type: Tunable White

Required components:
 C16142_HEKLA-SOCKET-K

Bender Wirth: 495 Typ L8

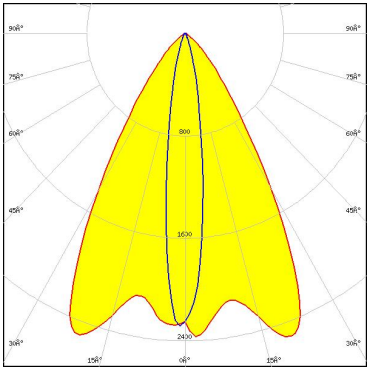

Light distribution files

LUMINUS

LED: CXM-3
 Ordering code: CP19104_AMY-70-O-B2
 FWHM / FWTM: 59.0 + 10.0° / 92.0 + 24.0°
 Efficiency: 92 %
 Peak intensity: 3.8 cd/lm
 LEDs/each optic: 1
 Light colour/type: White

Required components:

Bender Wirth: 634a Bayonet35L

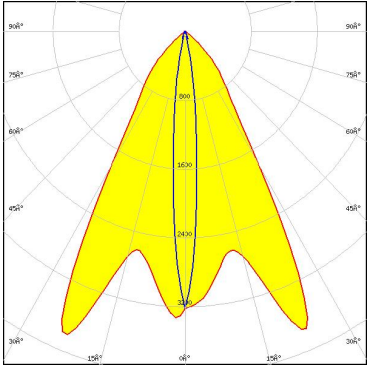

Light distribution files

LUMINUS

LED: CXM-4
 Ordering code: CP19104_AMY-70-O-B2
 FWHM / FWTM: 60.0 + 11.0° / 92.0 + 26.0°
 Efficiency: 91 %
 Peak intensity: 3.5 cd/lm
 LEDs/each optic: 1
 Light colour/type: White

Required components:

Bender Wirth: 634a Bayonet35L

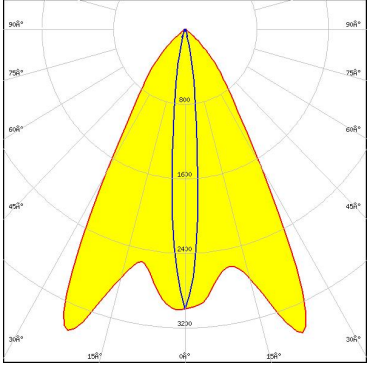

Light distribution files

OPTICAL RESULTS (SIMULATED):

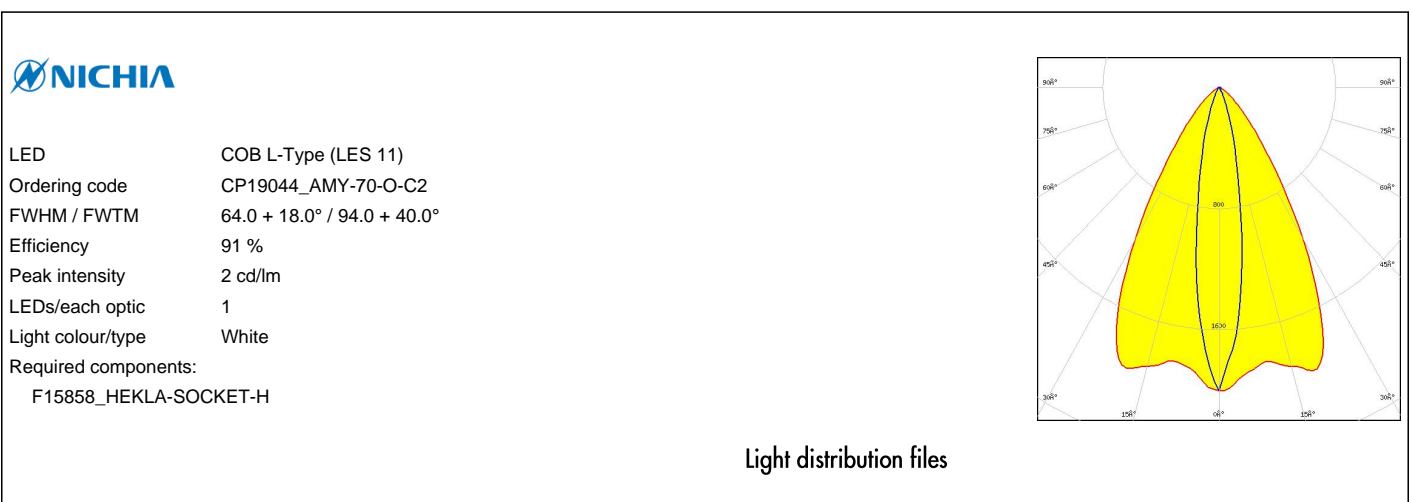
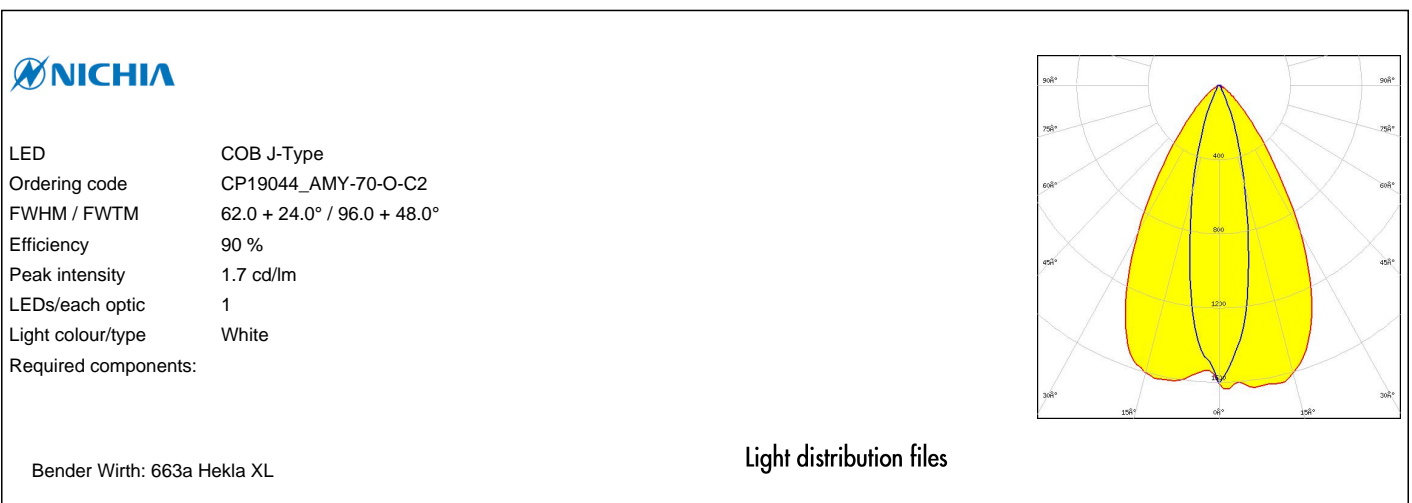
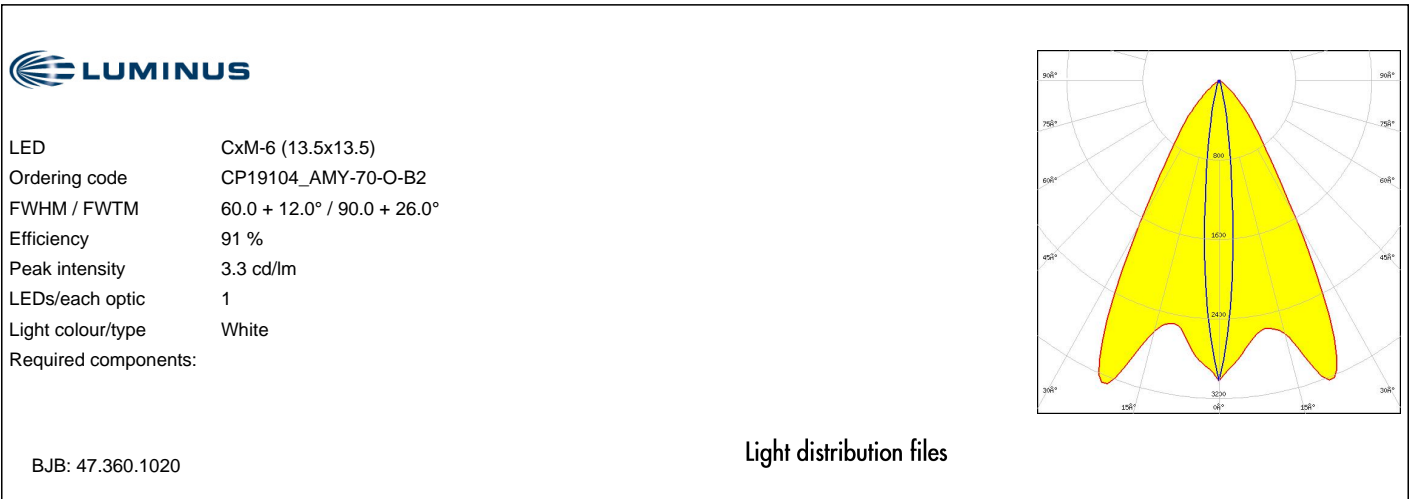

OPTICAL RESULTS (SIMULATED):



LED COB S-Type (LES 6)
Ordering code CP19104_AMY-70-O-B2
FWHM / FWTM 62.0 + 12.0° / 94.0 + 28.0°
Efficiency 91 %
Peak intensity 3 cd/lm
LEDs/each optic 1
Light colour/type White
Required components:

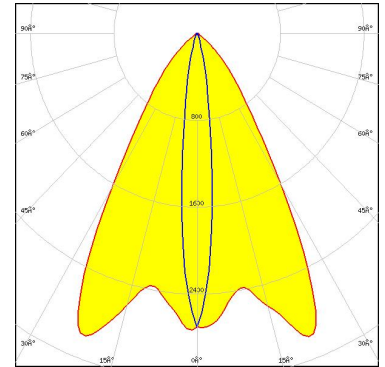

Light distribution files



LED COB S-Type (LES 7)
Ordering code CP19104_AMY-70-O-B2
FWHM / FWTM 62.0 + 13.0° / 94.0 + 30.0°
Efficiency 91 %
Peak intensity 2.8 cd/lm
LEDs/each optic 1
Light colour/type White
Required components:

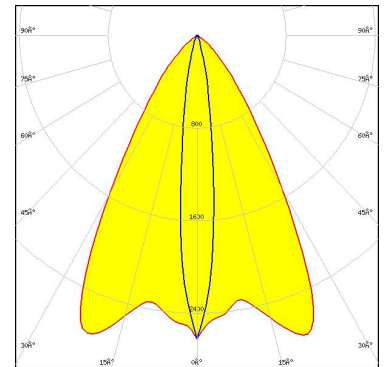

Bender Wirth: 652a Bayonet35L

Light distribution files



LED COB T-Type
Ordering code CP19104_AMY-70-O-B2
FWHM / FWTM 62.0 + 13.0° / 94.0 + 30.0°
Efficiency 91 %
Peak intensity 2.9 cd/lm
LEDs/each optic 1
Light colour/type White
Required components:

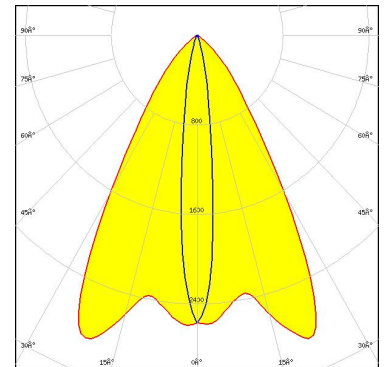

Bender Wirth: 652a Bayonet35L

Light distribution files

OPTICAL RESULTS (SIMULATED):

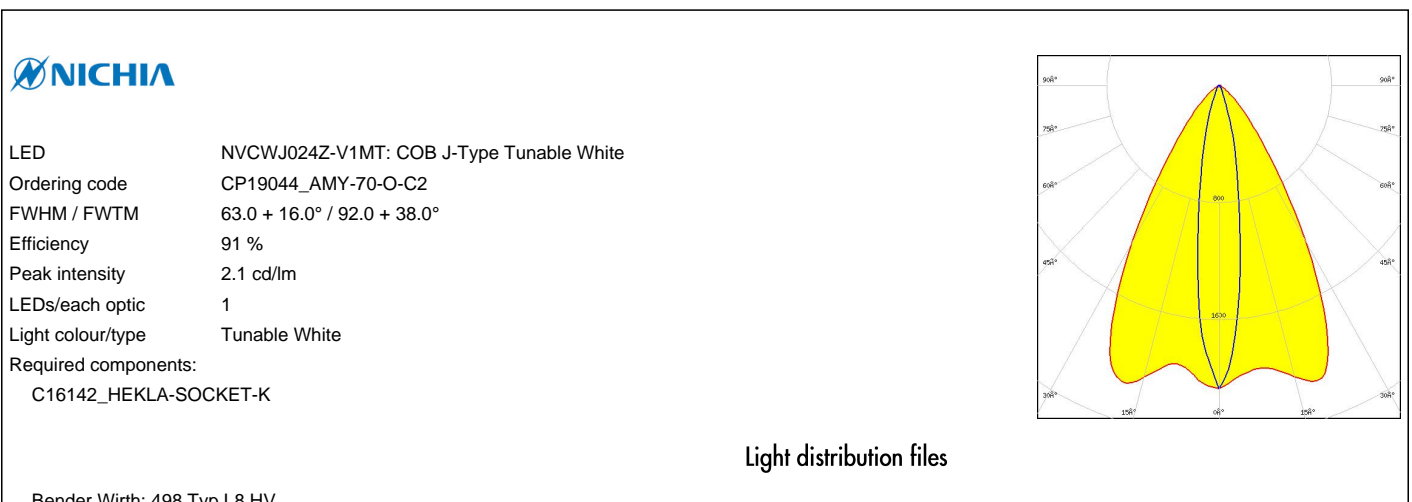
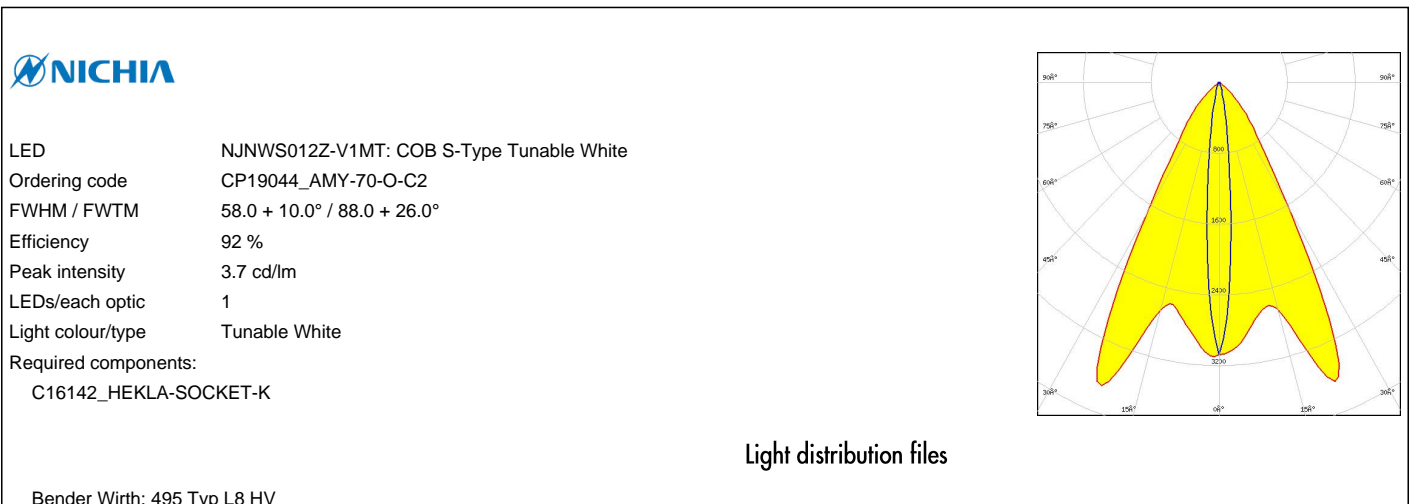
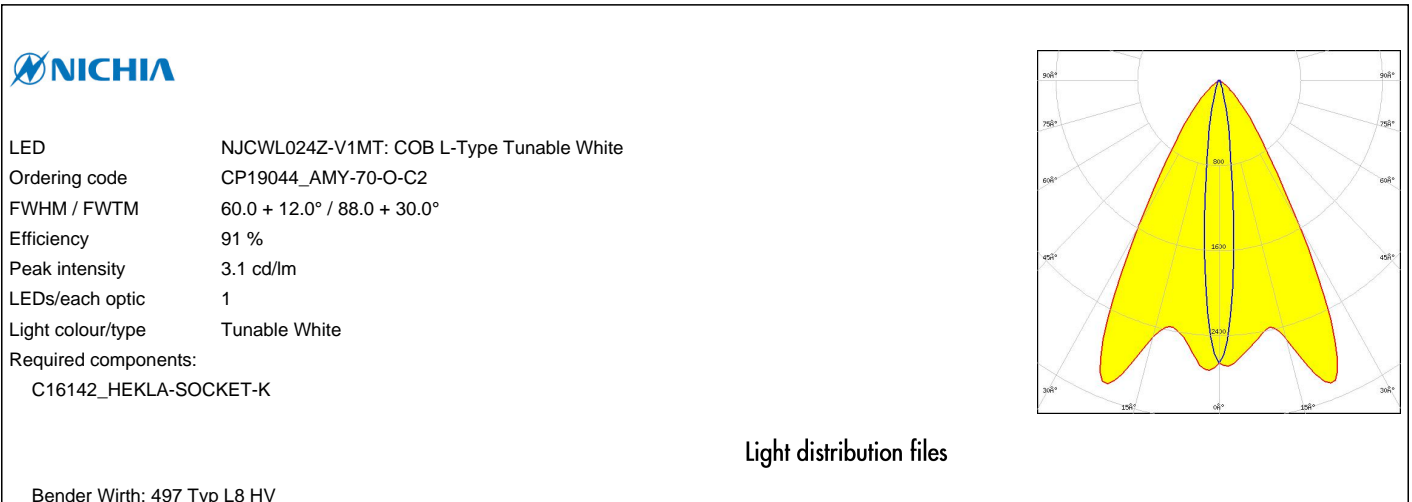

OPTICAL RESULTS (SIMULATED):

PHILIPS

LED	Fortimo SLM L15 CoB
Ordering code	CP19044_AMY-70-O-C2
FWHM / FWTM	63.0 + 23.0° / 95.0 + 48.0°
Efficiency	84 %
Peak intensity	1.6 cd/lm
LEDs/each optic	1
Light colour/type	White
Required components:	

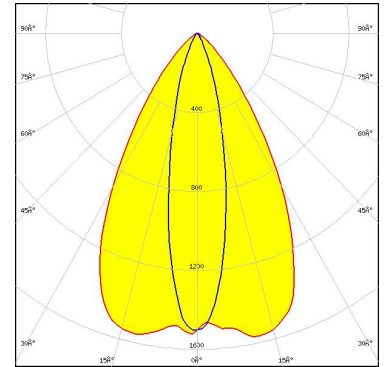

Bender Wirth: 632a Hekla XL

Light distribution files

SAMSUNG

LED	LC010C G2
Ordering code	CP19104_AMY-70-O-B2
FWHM / FWTM	60.0 + 12.0° / 90.0 + 26.0°
Efficiency	91 %
Peak intensity	3.3 cd/lm
LEDs/each optic	1
Light colour/type	White
Required components:	

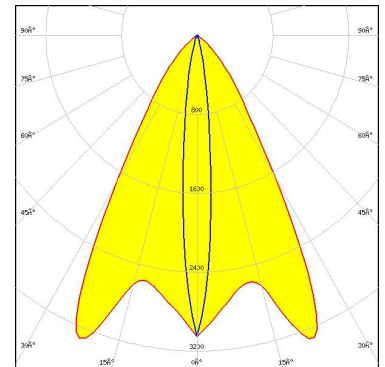

BJB: 47.360.1020

Light distribution files

SAMSUNG

LED	LC010T (Tunable White)
Ordering code	CP19044_AMY-70-O-C2
FWHM / FWTM	62.0 + 14.0° / 90.0 + 32.0°
Efficiency	92 %
Peak intensity	2.8 cd/lm
LEDs/each optic	1
Light colour/type	Tunable White
Required components:	C16142_HEKLA-SOCKET-K

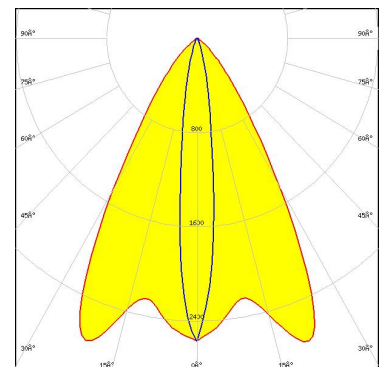

Bender Wirth: 501 Typ L8

Light distribution files

OPTICAL RESULTS (SIMULATED):

SAMSUNG

LED LC016D / LC019D / LC026D / LC033D
Ordering code C18466_AMY-70-O
FWHM / FWTM 62.0 + 22.0° / 94.0 + 50.0°
Efficiency 93 %
Peak intensity 1.6 cd/lm
LEDs/each optic 1
Light colour/type White
Required components:

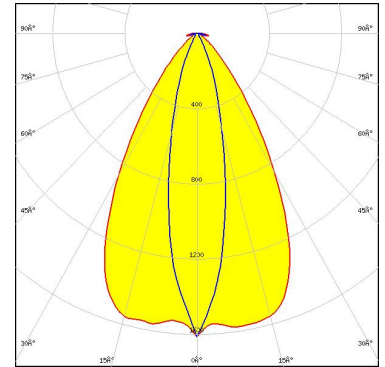

Light distribution files

SAMSUNG

LED LC016D / LC019D / LC026D / LC033D
Ordering code CP19044_AMY-70-O-C2
FWHM / FWTM 64.0 + 24.0° / 96.0 + 53.0°
Efficiency 84 %
Peak intensity 1.4 cd/lm
LEDs/each optic 1
Light colour/type White
Required components:
F15859_HEKLA-SOCKET-I

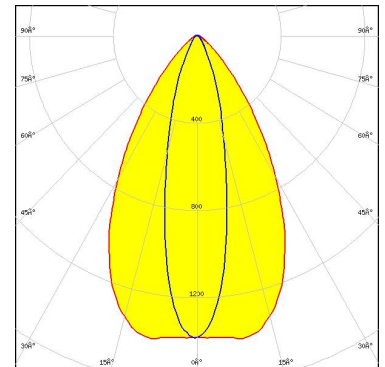

Light distribution files

SAMSUNG

LED LC016D / LC019D / LC026D / LC033D
Ordering code CP19104_AMY-70-O-B2
FWHM / FWTM 62.0 + 24.0° / 94.0 + 50.0°
Efficiency 86 %
Peak intensity 1.6 cd/lm
LEDs/each optic 1
Light colour/type White
Required components:

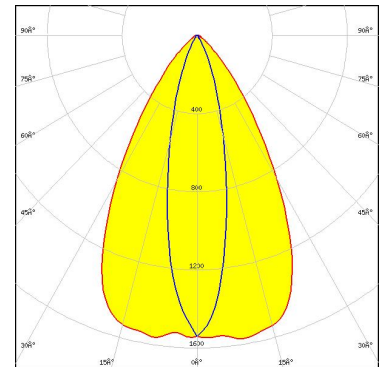

Light distribution files

BJB: 47.360.1010

OPTICAL RESULTS (SIMULATED):

SAMSUNG

LED LC020C G2
Ordering code CP19104_AMY-70-O-B2
FWHM / FWTM 62.0 + 14.0° / 91.0 + 34.0°
Efficiency 90 %
Peak intensity 2.5 cd/lm
LEDs/each optic 1
Light colour/type White
Required components:

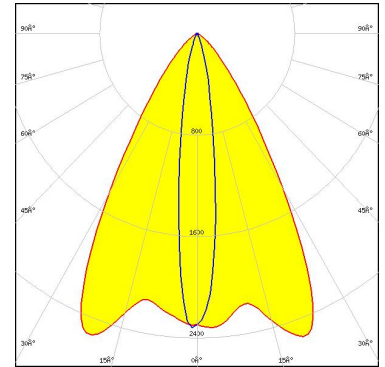

BJB: 47.360.1010

Light distribution files

SAMSUNG

LED LC020T (Tunable white)
Ordering code CP19044_AMY-70-O-C2
FWHM / FWTM 62.0 + 18.0° / 92.0 + 40.0°
Efficiency 91 %
Peak intensity 2.1 cd/lm
LEDs/each optic 1
Light colour/type Tunable White
Required components:
C16142_HEKLA-SOCKET-K

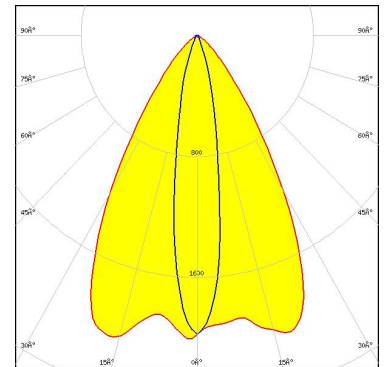

Bender Wirth: 501 Typ L8

Light distribution files

SAMSUNG

LED LC030C/040C G2
Ordering code CP19104_AMY-70-O-B2
FWHM / FWTM 63.0 + 19.0° / 94.0 + 40.0°
Efficiency 89 %
Peak intensity 2 cd/lm
LEDs/each optic 1
Light colour/type White
Required components:

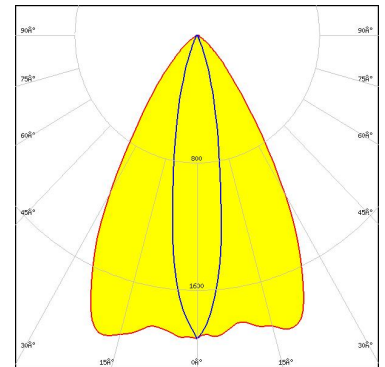

BJB: 47.360.1010

Light distribution files

OPTICAL RESULTS (SIMULATED):

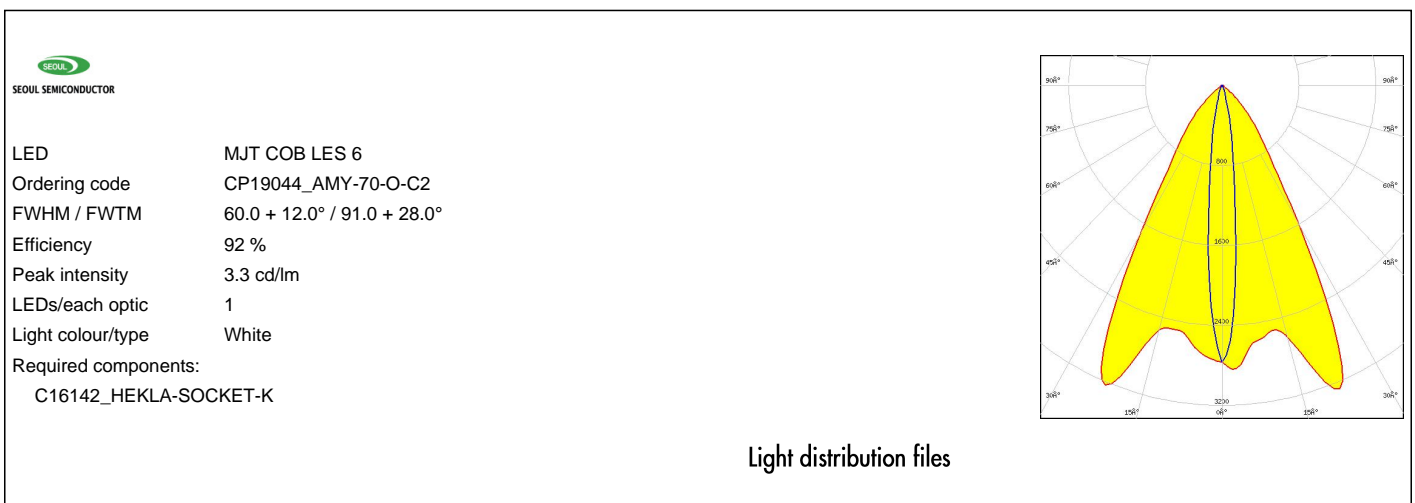
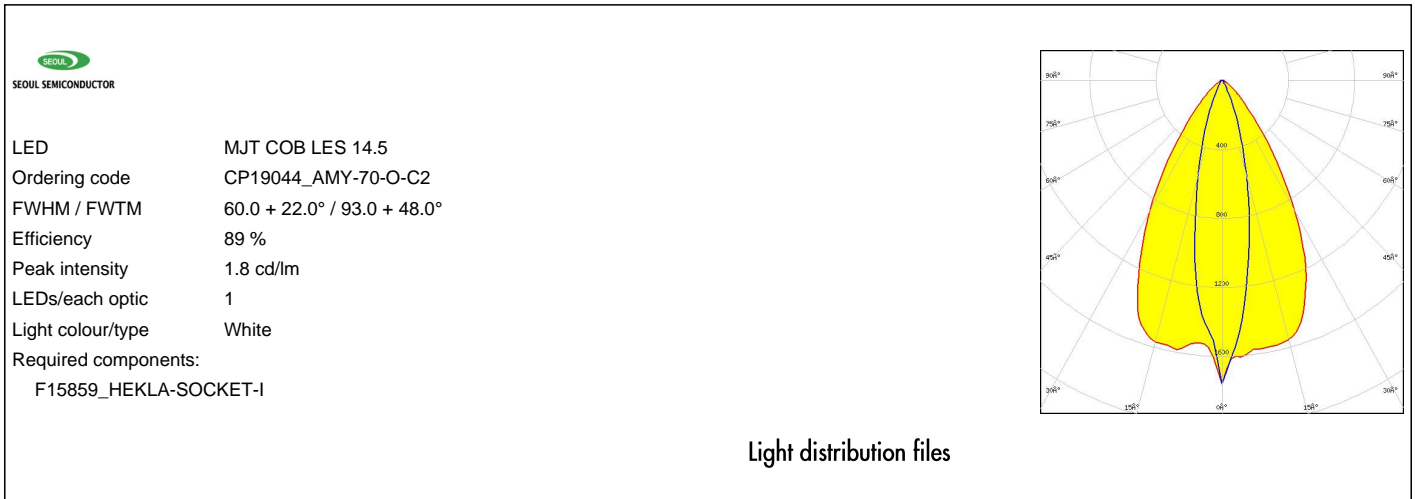

OPTICAL RESULTS (SIMULATED):

XICATO

LED	XOB 14.5 mm
Ordering code	CP19044_AMY-70-O-C2
FWHM / FWTM	61.0 + 21.0° / 92.0 + 42.0°
Efficiency	80 %
Peak intensity	1.7 cd/lm
LEDs/each optic	1
Light colour/type	White
Required components:	
F17438_HEKLA-G2-I	

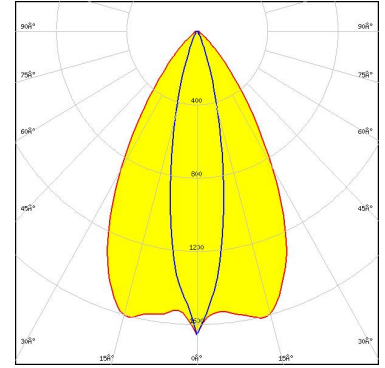

Light distribution files

GENERAL INFORMATION:

NOTE: The typical beam angle will be changed by different color, chip size and chip position tolerance. The typical total beam angle is the full angle measured where the luminous intensity is half of the peak value.

Due to use of high power COB's with this product, special attention to proper thermal design is highly recommended. LEDiL has no liability for direct, indirect or consecutive damages arising from the LEDiL products being used outside of the recommended temperature range.

MATERIALS:

As part of our continuous research and improvement processes, and to ensure the best possible quality and availability of our products, LEDiL reserves the right to change material grades without notice.

PRODUCT DATA USER AGREEMENT AND DISCLAIMER:

The measured data in the provided downloadable LEDiL Product Datasheets and Mechanical 2D-Drawings is rounded and provided as reference for planning. LEDiL Oy's optical specifications have been verified by conducting performance testing of the products in accordance with the company's quality system. The reported data are averaged results of multiple measurements with typical variation. LEDiL Oy reserves the right to without prior notification make changes and improvements to its products.

LEDiL Oy assumes neither warranty, nor guarantee nor any other liability of any kind for the contents and correctness of the provided data. The provided data has been generated with highest diligence but the provided data may in reality not represent the complete possible variation range of all intrinsic parameters. Therefore, in certain cases a deviation from the provided data could occur.

LEDiL Oy reserves the right to undertake technical changes of its products without further notification which could lead to changes in the provided data. LEDiL Oy assumes no liability of any kind for the possible deviation from any provided data or any other damage resulting from the usage of the provided data.

The user agrees to this disclaimer and user agreement with the download or usage of the provided files.

LEDiL Oy

Joensuunkatu 7
FI-24240 SALO
Finland

LEDiL Inc.

228 West Page Street
Suite D
Sycamore IL 60178
USA

Ledil Optics Technology (Shenzhen) Co., Ltd.

405 , Block B
Casic Motor Building
Shenzhen 518057
P.R.CHINA

Local sales and technical support

[www.ledil.com/
where_to_buy](http://www.ledil.com/where_to_buy)

Shipping locations

Poznan, Poland
Hong Kong, China

Distribution Partners

[www.ledil.com/
where_to_buy](http://www.ledil.com/where_to_buy)