

Cables and multistrand wires Main catalog

Test and Measurement

EN

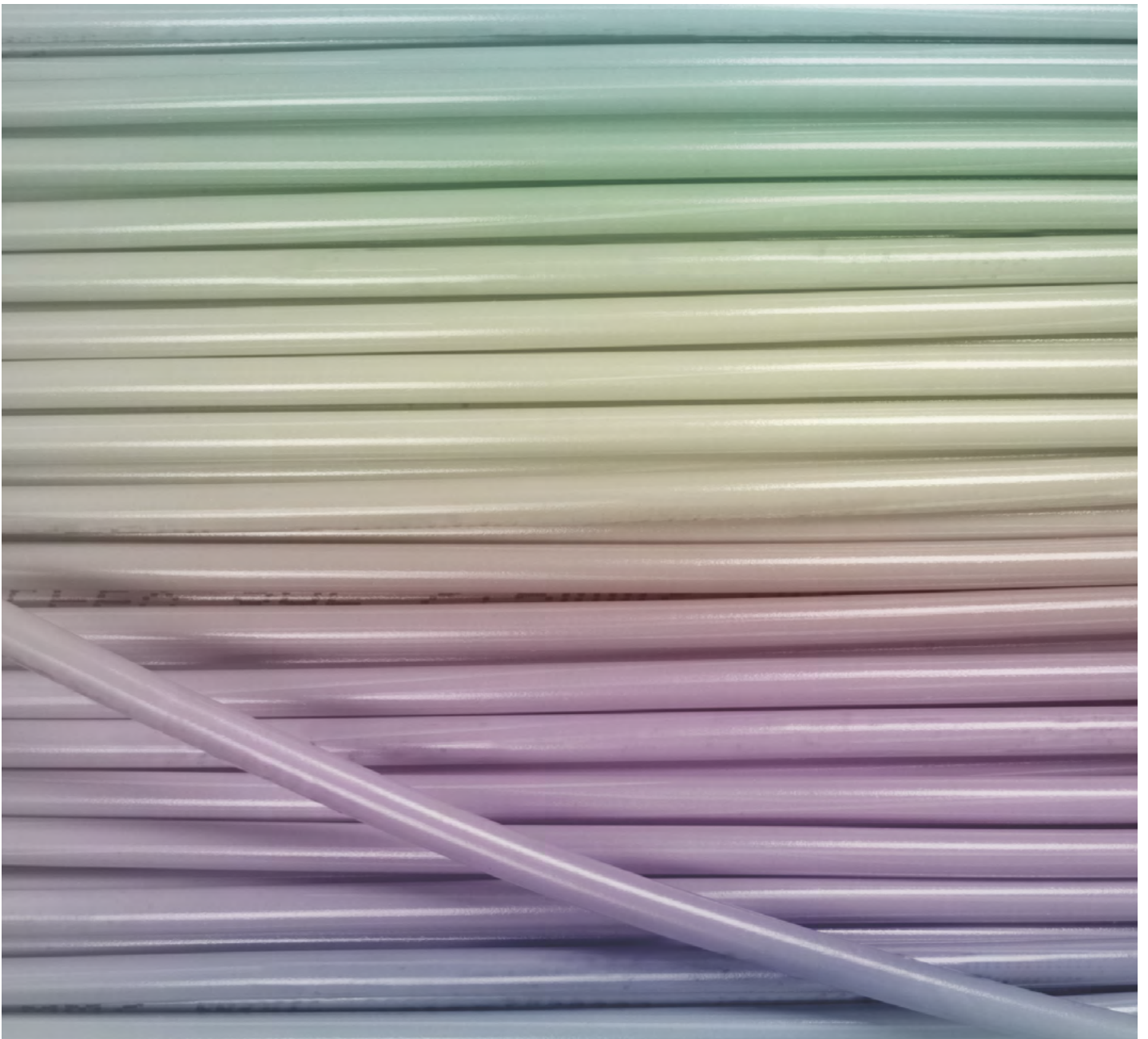

STÄUBLI ELECTRICAL CONNECTORS

Connections for Life



Stäubli, as the international technology leader, offers innovative mechatronics solutions in its four divisions: Electrical Connectors, Fluid Connectors, Robotics, and Textile. At Stäubli Electrical Connectors, we develop advanced connection solutions based on the reliable MULTILAM contact technology.

Together for reliable and safe connections

We know that you entrust us with the functionality of your applications and we work hard to ensure this every single day. Thanks to our high level of expertise, our extensive experience and the multiple successful co-operation with our partners, numerous new developments have originated at Stäubli Electrical Connectors and subsequently have become worldwide standards. This includes our MC4 connector portfolio for which we are today the global market

We create connections for life – and our customers are at the center of these connections. We are convinced that solid and stable partnerships directly contribute to our mutual success.

We take on the needs of our partners and deal with the most extraordinary challenges. As a result, we always create, sell and

leader in photovoltaic. As the Stäubli original, the MC4 represents the result of our constant quest for innovation, quality and safety.

Further examples are the CombiTac modular connector system or the Quick Charging Connector (QCC) for automatic charging systems.

We ensure connections for life together with our long-standing customers in a wide range of industries from renewable energies, power transmission and distribution and E-mobility to industrial automation applica-

support reliable and long-lasting products for markets with the highest productivity and safety requirements in close cooperation with our customers.

tions, railway and welding automation, test and measurement and medical devices.

Thus, developing reliable, efficient and safe solutions based on our proven MULTILAM contact technology, which guarantees a high service lifetime in addition to highly efficient power transmission.

Applications and advantages



Stäubli Electrical Connectors looks back on years of experience in the production of multi-stranded wires with PVC, silicone and TPE insulating materials.

Our multi-stranded wires are based on super-fine, bright-soft electrolytic copper strands. Depending on the cross section,

these may consist of hundreds or even thousands of individual wires, the majority with a diameter between 0.05 mm and 0.10 mm, stranded in a short twist.

The resulting high number of windings in combination with highly elastic insulating materials creates finished leads with an exceptional flexibility. Through the selection

and combination of the finest raw materials, as well as the constant modernization of our production facilities, the range of multi-stranded wires has been extended over the years and adapted to the latest technical requirements and standards.

Contents

Page 6	Ordering Information General information Package types
Page 8	PVC Insulated Multistrand Wires
Page 13	TPE Insulated Multistrand Wires
Page 16	Silicone Insulated Multistrand Wires
Page 21	High Voltage Wires
Page 23	Twin Wires
Page 24	Special Wires for Potential Equalization
Page 25	Shielded Wires
Page 26	Technical Information
Page 28	Index

UNLIMITED POSSIBILITIES FOR CONTACT SOLUTIONS

MULTILAM Technology



MULTILAM are specially formed and resilient contact elements. All Stäubli Electrical Connectors products benefit from the unique and outstanding performance of the **MULTILAM Technology**.

Thanks to their constant spring pressure, MULTILAM louvers ensure continuous contact with the contact surface, resulting in a constantly low contact resistance.

MULTILAM Technology allows to find solutions for connectors within the severest constraints and in certain products for up to 1 million mating cycles.

This makes the MULTILAM Technology the best choice for applications with demanding requirements:

- Reliable and longlife operation due to constantly high performance
- Safe operation under highest environmental demands on temperature, vibration and shock
- Particularly suitable for high current connectors, but also for data and signal contacts as well as for high voltage connections
- Automated solutions with a high number of mating cycles

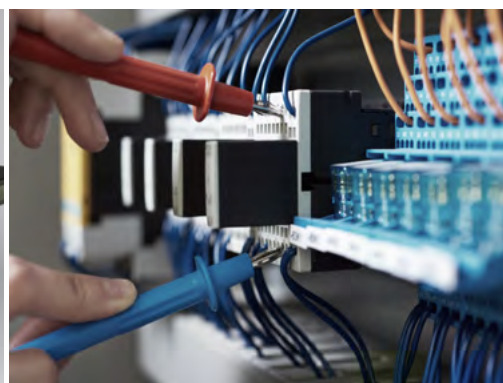

Ordering information regarding our multistrand wires

We sell our multi-strand wires on reels of various sizes, relative to the types of wire (see page 7).

For our standard order quantity, 100 metres, please order our 100 reel (order number 6X.XXXX-100*). For longer wires, please order our 999 reel (order number 6X.XXXX-999*). When ordering, please add

the order number of the desired wire to the respective order number and replace the asterisk with the two-digit color code.

Delivery of wires below the standard order quantity is only possible on request.

General information

Colour code

For those items available in various colours, replace the asterisk "*" with the appropriate colour code.

20	green-yellow	27	brown
21	black	28	grey
22	red	29	white
23	blue	30	orange
24	yellow	33	transparent
25	green	34	natural
26	violet		

Changes / Provisos

All data, illustrations and drawings in the catalogue have been carefully checked. They are in accordance with our experience to date, but no responsibility can be accepted for errors. We also reserve the right to make modifications for design and safety reasons. When designing equipment incorporating our components, it is therefore advisable not to rely solely on the data in the catalogue but to consult us to make sure this information is up to date. We shall be pleased to advise you.

Copyright

The use of this catalogue for any other purpose, in whatever form, without our prior written consent is not permitted.

European safety standards

All articles comply with the regulations of the following European directives:

- Directive 2011/65/EC (RoHS) on the restriction of the use of certain hazardous substances in electrical and electronic equipment.
- Directive 2014/35/EU (LVD) on the harmonization of the legislation of Member States relating to the making available on the market of electrical equipment designed for use within certain voltage limits.

Conformity with these directives is demonstrated by compliance with the following harmonized standards:

EN IEC 63000:2018
 EN 61010-031:2015, EN 50363-0:2011,
 EN 50395:2005, EN 50396:2005,
 EN 60228:2005, EN 62230:2014,
 IEC 60502-2:2014

Package types

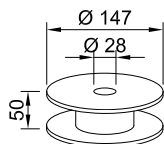

Reel A

Plastic reel for 100-metre lengths of wires with small outside diameter.

Empty weight: 0.13 kg

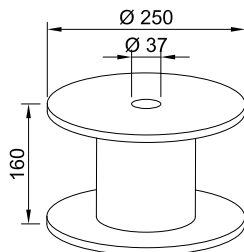

Reel C

Wooden reel for 50 or 100 metres for wires with larger outside diameter and for greater lengths of wires with small and medium outside diameter.

Empty weight: 0.75 kg

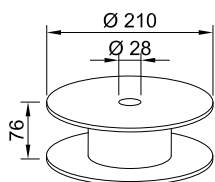

Reel B

Plastic reel for 100-metre lengths of wires with medium outside diameter and for greater lengths of wires with smaller outside diameter.

Empty weight: 0.2 kg

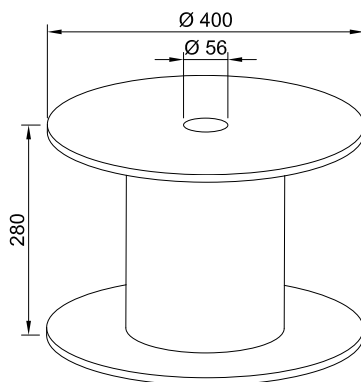

Reel D

Wooden reel specially designed for extremely long wire lengths and for wires with large outside diameter.

Empty weight: 2 kg

PVC Insulated Multistrand Wires

Insulating Material PVC

General characteristics

Good electrical properties with medium to good flexibility and good age resistance.

Resistance to environmental influences

Medium to good UV resistance depending on colour.

Typical application

Universal use for test leads and wiring with medium mechanical stress and a good cost-benefit ratio.

Used for the following wire types

FlexiVolt..., FlexiStrom..., FLEXI-...

Technical specifications	
Temperature range (permanent, fully flexible)	-10 °C ... +70 °C
Maximum elongation	280 %
Tear strength	15 N/mm ²
Hardness	70 Shore A

FlexiVolt-E

Highly flexible basic insulated stranded wire.

Typical Application

Internal wiring of mobile components under moderate mechanical stress. Highly flexible connecting leads for low-voltage applications in the laboratory field.



Order No.	Type	Nominal cross section	Strand design	Weight of cable	Conductor diameter	Thickness insulation wall	Outer diameter	Rated voltage	Test voltage	Rated current	Certification marks	*Colours
	PVC	mm ²	n x Ø mm	kg/km	mm	mm	mm	AC V	AC V	A		
60.7001-□*	FLEXI-E 0,10	0.10	26 x 0.07	1.8	0.40	0.30	1.0	150	2000	2	<div style="display: flex; flex-direction: column; align-items: center;"> <div style="margin-bottom: 10px;">CE</div> <div style="margin-bottom: 10px;">UK RA</div> <div style="margin-bottom: 10px;">EAC</div> </div>	21 22 23 24 25 29
60.7002-□*	FLEXI-E 0,15	0.15	39 x 0.07	3.5	0.50	0.50	1.5	500	5000	4		21 22 23 25
60.7013-□*	FLEXI-E/HK 0,25	0.25	129 x 0.05	3.9	0.70	0.35	1.4	300	5000	6		21 22 23 25 29
60.7003-□*	FLEXI-E 0,25	0.25	66 x 0.07	4.8	0.65	0.50	1.7	500	5000	6		21 22 23 24 25
60.7005-□*	FLEXI-E/HK 0,50	0.50	256 x 0.05	8.3	1.0	0.55	2.1	500	6000	10		21 22 23 24 25 29
60.7004-□*	FLEXI-E 0,50	0.50	129 x 0.07	8.3	0.90	0.60	2.1	500	6000	10		21 22 23 24 25 29
60.7006-□*	FLEXI-E 0,75	0.75	196 x 0.07	11	1.25	0.55	2.3	500	6000	15		21 22 23
60.7009-□*	FLEXI-E/HK 1,0	1.0	511 x 0.05	14	1.5	0.60	2.7	750	7500	19		21 22 23 24 29
60.7008-□*	FLEXI-E 1,0	1.0	259 x 0.07	15	1.4	0.65	2.7	750	7500	19		20 21 22 23 24
60.7010-□*	FLEXI-E 1,5	1.5	392 x 0.07	20	1.7	0.65	3.0	750	7500	24		21 22 23
60.7012-□*	FLEXI-E 2,5	2.5	651 x 0.07	32	2.3	0.65	3.6	750	7500	32	20 21 22 23 24 25	

FlexiVolt-1V

Highly flexible stranded wire with reinforced insulation.

Typical Application

Manufacture of test leads and external wiring of movable elements.



Order No.	Type	Nominal cross section	Strand design	Weight of cable	Conductor diameter	Thickness insulation wall	Outer diameter	Rated voltage	Test voltage	Rated current	Certification marks	*Colours
	PVC	mm ²	n x Ø mm	kg/km	mm	mm	mm	AC/DC V	AC V	A		
60.7085-□*	FLEXI-1V 0,50	0.50	129 x 0.07	9.2	0.90	0.70	2.3	AC 1000 DC 1500	10,000	10	 	21 22 29
60.7086-□*	FLEXI-1V 0,75	0.75	196 x 0.07	18	1.25	1.1	3.5	AC 1000 DC 1500	10,000	15		20 21 22 29
60.7087-□*	FLEXI-1V 1,0	1.0	259 x 0.07	23	1.4	1.25	3.9	AC 1000 DC 1500	10,000	19		21 22 29
60.7088-□*	FLEXI-1V 1,5	1.5	392 x 0.07	27	1.7	1.1	3.9	AC 1000 DC 1500	10,000	24		20 21 22
60.7125-□*	FLEXI-1V 2,5	2.5	651 x 0.07	34	2.3	0.8	3.9	AC 1000 DC 1500	10,000	32		20 21 22 23

¹⁾ UL recognized: File E120880, AWM
Application: FLEXI up to 75 °C; PLAST and SILI up to 105 °C as measurement strand.

FlexiVolt-2V

Highly flexible stranded wire with reinforced, double-layer insulation for the highest safety (inside natural or white, outside coloured). Damage to the outer layer of insulation can be more easily recognised due to the different colour of the underlying layer.

Typical Application

Manufacture of test leads and external wiring of movable elements.

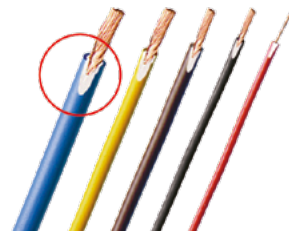

Order No.	Type	Nominal cross section	Strand design	Weight of cable	Conductor diameter	Thickness insulation wall	Outer diameter	Rated voltage	Test voltage	Rated current	Certification marks	*Colours
	PVC	mm ²	n x Ø mm	kg/km	mm	mm	mm	AC/DC V	AC V	A		
60.7026-□*	FLEXI-2V 0,25	0.25	66 x 0.07	6.0	0.65	0.65	2.0	AC 1000 DC 1500	10,000	6	CE UK EAC	21 22 23
60.7027-□*	FLEXI-2V 0,50	0.50	129 x 0.07	9.2	0.90	0.72	2.33	AC 1000 DC 1500	10,000	10	UL ¹⁾ CE UK EAC	21 22 23
60.7941-□*	FLEXI-2V/HK 0,75-D	0.75	196 x 0.07	21	1.25	1.3	3.9	AC 1000 DC 1500	10,000	15		20 21 22 23 24 25 27
60.7028-□*	FLEXI-2V 0,75	0.75	196 x 0.07	18	1.25	1.1	3.5	AC 1000 DC 1500	10,000	15		21 22 23
60.7030-□*	FLEXI-2V 1,0	1.0	259 x 0.07	23	1.4	1.25	3.9	AC 1000 DC 1500	10,000	19		21 22 23 24 25 26 27 29
60.7031-□*	FLEXI-2V 1,5	1.5	392 x 0.07	27	1.7	1.1	3.9	AC 1000 DC 1500	10,000	24		21 22 23
60.7033-□*	FLEXI-2V/HK 2,5-D	2.5	651 x 0.07	34	2.3	0.8	3.9	AC 1000 DC 1500	10,000	32		20 21 22 23 24 25 29
60.7032-□*	FLEXI-2V 2,5	2.5	651 x 0.07	38	2.3	1.0	4.4	AC 1000 DC 1500	10,000	32		21 22 23 24 25 26
60.7034-□*	FLEXI-2V 4,0	4.0	1036 x 0.07	64	3.0	1.5	6.0	AC 1000 DC 1500	10,000	42		21 22 23
60.7035-□*	FLEXI-2V 6,0	6.0	1548 x 0.07	95	3.5	1.75	7.0	AC 1000 DC 1500	12,000	54		21 22 23

¹⁾ UL recognized: File E120880, AWM
Application: FLEXI up to 75 °C; PLAST and SILI up to 105 °C as measurement strand.

FlexiStrom

Highly flexible stranded wire with reinforced insulation.

Typical Application

Current feeds and earth/ground wires in machine, plant and accumulator construction.
Safety test leads carrying high currents.



Order No.	Type	Nominal cross section	Strand design	Weight of cable	Conductor diameter	Thickness insulation wall	Outer diameter	Rated voltage	Test voltage	Rated current	Certification marks	*Colours
	PVC	mm ²	n x Ø mm	kg/km	mm	mm	mm	AC/DC V	AC V	A		
60.7014-□*	FLEXI-S 4,0	4.0	1036 x 0.07	52	3.0	0.90	4.8	AC 1000 DC 1500	10,000	42	 	20 21 22 23 33
60.7015-□*	FLEXI-S 6,0	6.0	1548 x 0.07	80	3.7	1.1	5.9	AC 1000 DC 1500	10,000	54		20 21 22 23
60.7017-□*	FLEXI-S 10	10	2556 x 0.07	120	4.8	1.1	7.0	AC 1000 DC 1500	10,000	73		20 21 22 23
60.7018-□*	FLEXI-S 16	16	4116 x 0.07	202	6.1	1.2	8.5	AC 1000 DC 1500	10,000	98		20 21 22 23
60.7020-□*	FLEXI-S 25	25	6384 x 0.07	280	7.0	1.4	9.8	AC 1000 DC 1500	10,000	129		20 21 22 23

¹⁾ UL recognized: File E120880, AWM
Application: FLEXI up to 75 °C; PLAST and SILI up to 105 °C as measurement strand.

TPE Insulated Multistrand Wires

Insulating Material TPE

General characteristics

Excellent electrical properties (e.g. high insulation resistance), high tensile strength, high flexibility, nonabrasive and relatively lightweight (low density). The TPE is chlorine-free and thus environment-friendly.

Resistance to environmental influences

UV-, ozone- and weather-resistant.

Typical application

Used, for example, in test leads with a medium thermal load whilst retaining its flexibility in the cold.

Used for the following wire types

FlexiPlast..., PLAST-...

Technical specifications	
Temperature range (permanent)	-30 °C ... +90 °C (PLAST- ...)
Relative permittivity	~ 2.1 – 2.7
Loss factor (frequency-dependent)	~ 0.003 – 0.008
Maximum elongation	487 %
Tensile strength	7.2 N/mm ²
Hardness	66 Shore A

FlexiPlast-E FlexiPlast-1V

Highly flexible basic insulated stranded wire.

Typical Application

Internal wiring of mobile components under moderate mechanical stress. Highly flexible connecting leads for low-voltage applications in the laboratory field.

TPE-insulated leads can be used in a wider range of temperatures than comparable PVC-insulated leads. TPE has a substantially higher insulation resistance than PVC and is also free from chlorine, thus making a valuable contribution to the protection of the environment.

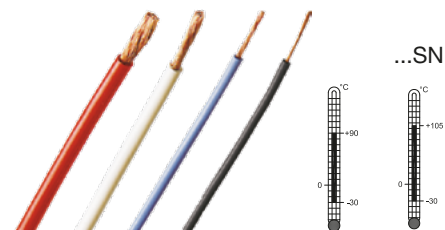

Order No.	Type	Nominal cross section	Strand design	Weight of cable	Conductor diameter	Thickness insulation wall	Outer diameter	Rated voltage	Test voltage	Rated current	Certification marks	*Colours
	TPE	mm ²	n x Ø mm	kg/km	mm	mm	mm	AC V	AC V	A		
60.7170-□*	PLAST-E 0,15	0.15	39 x 0.07	2.9	0.50	0.50	1.5	500	5000	4	CE UK CA EAC	21 22 23 24
60.7175-□*	PLAST-E 0,25	0.25	66 x 0.07	4.1	0.65	0.50	1.7	500	5000	6		21 22 23
60.7180-□*	PLAST-E 0,50	0.50	129 x 0.07	7.1	0.90	0.60	2.1	500	6000	10		21 22 23 29
60.7185-□*	PLAST-E 0,75	0.75	196 x 0.07	10	1.25	0.55	2.3	500	6000	15		21 22 23
60.7190-□*	PLAST-E 1,0	1.0	259 x 0.07	13	1.4	0.65	2.7	750	7500	19		21 22 23 24 29
60.7200-□*	PLAST-E 2,5	2.5	651 x 0.07	29	2.3	0.65	3.6	750	7500	32		21 22 23 25 29
60.7230-□*	PLAST-1V 2,5	2.5	651 x 0.07	31	2.3	0.8	3.9	AC 1000 DC 1500	10,000	32		21 22 23
60.7763-□*	PLAST-1V 0,50 SN	0.50	129 x 0.07	8.6	0.8	0.75	2.3	AC 1000 DC 1500	10,000	10	UL ¹⁾ CE	21 22
60.7768-□*	PLAST-1V 2,5 SN	2.5	651 x 0.07	33	2.3	0.8	3.9	AC 1000 DC 1500	10,000	32	UK CA EAC	21 22 23

¹⁾ UL recognized: File E120880, AWM
Application: FLEXI up to 75 °C; PLAST and SILI up to 105 °C as measurement strand.

FlexiPlast-2V

Highly flexible stranded wire with reinforced, double-layer insulation for the highest safety (inside natural, outside coloured). Damage to the outer layer of insulation can be more easily recognised due to the different colour of the underlying layer.

Typical Application

Hand-held test leads for maximum safety requirements and high thermal stress.



Order No.	Type	Nominal cross section	Strand design	Weight of cable	Conductor diameter	Thickness insulation wall	Outer diameter	Rated voltage	Test voltage	Rated current	Certification marks	*Colours
	TPE	mm ²	n x Ø mm	kg/km	mm	mm	mm	AC V	AC V	A		
60.7240-□*	PLAST-2V 0,25	0.25	66 x 0.07	4.9	0.65	0.65	2.0	AC 1000 DC 1500	10,000	6		21 22 23
60.7245-□*	PLAST-2V 0,50	0.50	129 x 0.07	7.8	0.90	0.70	2.3	AC 1000 DC 1500	10,000	10		21 22 23
60.7265-□*	PLAST-2V 2,0	2.0	525 x 0.07	27	2.0	0.95	3.9	AC 1000 DC 1500	10,000	30		21 22 23
60.7270-□*	PLAST-2V 2,5	2.5	651 x 0.07	34	2.3	1.05	4.4	AC 1000 DC 1500	10,000	32		21 22 23

Silicone Insulated Multistrand Wires

Insulating Material Silicone

General characteristics

The outstanding properties of the silicone insulation include excellent flexibility and the ability to withstand brief contact with a soldering iron.

Good age resistance, high impact value, maximum elongation and tear strength, halogen-free and thus environment-friendly.

Resistance to environmental influences

Very good weather and radiation resistance. Good chemical stability.

Typical application

Used, e.g. for making up maximum flexibility test leads, wiring very flexible parts. An important safety feature is the silicone ash

produced after burning which continues to insulate the wires in the event of a fire. This can mean the continued function of electrical installations in industrial plants.

Used for the following wire types

SiliVolt..., SiliStrom, SILI-... (SN)

Technical specifications

Temperature range	
- permanent (permanent steam-resistance)	-50 °C ... +150 °C
- several hours	... +250 °C
- temporary (eg. contact with soldering iron)	... +300 °C
Relative permittivity	~ 2.7 – 2.8
Loss factor (frequency-dependent)	~ 0.003
Dielectric strength	18 – 20 kV/mm
Maximum elongation	500 %
Tear strength (very high resistance to tearing)	8.3 N/mm ²
Hardness	60 Shore A



Highest flexibility and highest resistiveness

SiliVolt-E

Super flexible basic insulated stranded wire. Types ... SN with tinned wire strands for continuous use at temperatures up to 150 °C.

Typical Application

Internal wiring of very mobile components and assemblies under high thermal stress. Super flexible connecting leads for low-voltage applications in the laboratory field.

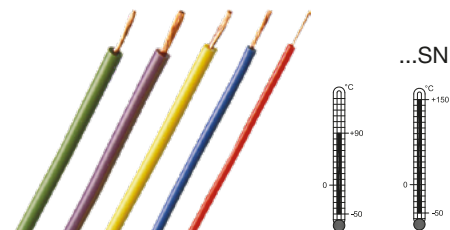

Order No.	Type	Nominal cross section	Strand design	Weight of cable	Conductor diameter	Thickness insulation wall	Outer diameter	Rated voltage	Test voltage	Rated current	Certification marks	*Colours
	SIL	mm ²	n x Ø mm	kg/km	mm	mm	mm	AC V	AC V	A		
61.7550-□*	SILI-E 0,15	0.15	39 x 0.07	2.1	0.50	0.3	1.1	150	2000	6	CE	21 22 23 24 25 27 29
61.7551-□*	SILI-E 0,25	0.25	66 x 0.07	4.5	0.65	0.50	1.7	300	5000	9	CE CB EAC	21 22 23 24 25 27 29
61.7552-□*	SILI-E 0,50	0.50	129 x 0.07	8.6	0.90	0.70	2.3	300	6000	10		21 22 23 24 25 29
61.7532-□*	SILI-E 0,50 SN	0.50	129 x 0.07	8.6	0.80	0.75	2.3	300	6000	10		21 22 23
61.7553-□*	SILI-E 0,75	0.75	196 x 0.07	12	1.25	0.70	2.7	600	6000	15	RU ¹⁾	20 21 22 23 29
61.7554-□*	SILI-E 1,0	1.0	259 x 0.07	16	1.4	0.80	3.0	600	7000	19	CE CB EAC	20 21 22 23 24 25
61.7555-□*	SILI-E 1,5	1.5	392 x 0.07	22	1.7	0.85	3.4	600	7000	24		20 21 22 23 26
61.7556-□*	SILI-E 2,5	2.5	651 x 0.07	33	2.3	0.8	3.9	600	7000	32		20 21 22 23 24 25 27
61.7537-□*	SILI-E 2,5 SN	2.5	651 x 0.07	33	2.4	0.75	3.9	600	7000	32		21 22 23

¹⁾ UL recognized: File E120880, AWM
Application: FLEXI up to 75 °C; PLAST and SILI up to 105 °C as measurement strand.

SiliVolt-1V

Super flexible stranded wire with reinforced insulation. Types ... SN with tinned wire strands for continuous use at temperatures up to 150 °C.

Typical Application

Hand-held test leads for high thermal stress.

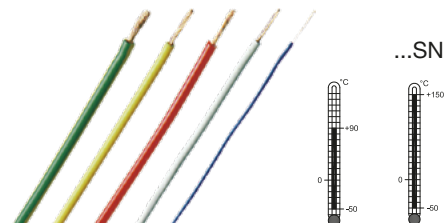

Order No.	Type	Nominal cross section	Strand design	Weight of cable	Conductor diameter	Thickness insulation wall	Outer diameter	Rated voltage	Test voltage	Rated current	Certification marks	*Colours
	SIL	mm ²	n x Ø mm	kg/km	mm	mm	mm	AC/DC V	AC V	A		
61.7603-□*	SILI-1V 0,15	0.15	39 x 0.07	3.2	0.50	0.50	1.5	300	5000	6	CE DIN EAC	21 22 23 24
61.7604-□*	SILI-1V 0,25	0.25	129 x 0.05	5.5	0.70	0.65	2.0	300	6000	9	CE DIN EAC	21 22 23 24
61.7605-□*	SILI-1V 0,50	0.50	256 x 0.05	10	1.0	0.85	2.7	AC 1000 DC 1500	10,000	12	CE DIN EAC	21 22 23 24 25 29
61.7642-□*	SILI-1V 0,50 SN	0.50	129 x 0.07	10	0.80	0.95	2.7	AC 1000 DC 1500	10,000	12	CE DIN EAC	21 22 23
61.7122-□*	SILI-1V 0,75/3,2	0.75	385 x 0.05	15	1.25	0.95	3.2	AC 1000 DC 1500	10,000	15	CE DIN EAC	21 22
61.7606-□*	SILI-1V 0,75	0.75	385 x 0.05	17	1.25	1.1	3.5	AC 1000 DC 1500	10,000	15	UL ¹⁾ CE DIN EAC	20 21 22 23 24 25 27 29
61.7607-□*	SILI-1V 1,0	1.0	511 x 0.05	21	1.5	1.2	3.9	AC 1000 DC 1500	10,000	19	CE DIN EAC	20 21 22 23 24 25 26 28 29
61.7644-□*	SILI-1V 1,0 SN	1.0	259 x 0.07	21	1.4	1.2	3.9	AC 1000 DC 1500	10,000	19	CE DIN EAC	21 22
61.7608-□*	SILI-1V 1,5	1.5	770 x 0.05	25	1.8	1.05	3.9	AC 1000 DC 1500	10,000	24	CE DIN EAC	21 22 23
61.7610-□*	SILI-1V 2,5	2.5	651 x 0.07	38	2.3	1.15	4.6	AC 1000 DC 1500	10,000	32	CE DIN EAC	21 22 23 24 25 27 28

¹⁾ UL recognized: File E120880, AWM
Application: FLEXI up to 75 °C; PLAST and SILI up to 105 °C as measurement strand.

SiliVolt-2V

Super flexible stranded wire with reinforced, double-layer insulation for the highest safety (inside natural, outside coloured). Damage to the outer layer of insulation can be more easily recognised due to the different colour of the underlying layer. Types ... SN

with tinned wire strands for continuous use at temperatures up to 150 °C.

Typical Application

Hand-held test leads for maximum safety requirements and high thermal stress.

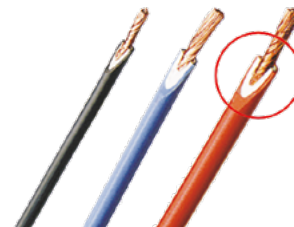

Order No.	Type	Nominal cross section	Strand design	Weight of cable	Conductor diameter	Thickness insulation wall	Outer diameter	Rated voltage	Test voltage	Rated current	Certification marks	*Colours
	SIL	mm ²	n x Ø mm	kg/km	mm	mm	mm	AC/DC V	AC V	A		
61.7662-□*	SILI-2V 0,50	0.50	256 x 0.05	10	1.0	0.85	2.7	AC 1000 DC 1500	10,000	12		21 22 23
61.7663-□*	SILI-2V 0,75	0.75	385 x 0.05	17	1.25	1.1	3.5	AC 1000 DC 1500	10,000	15		21 22 23 27 28
61.7664-□*	SILI-2V 1,0	1.0	511 x 0.05	21	1.5	1.2	3.9	AC 1000 DC 1500	10,000	19		21 22 23 25
61.7667-□*	SILI-2V 2,5	2.5	651 x 0.07	38	2.3	1.15	4.6	AC 1000 DC 1500	10,000	32		21 22 23 28

¹⁾ UL recognized: File E120880, AWM
Application: FLEXI up to 75 °C; PLAST and SILI up to 105 °C as measurement strand.

SiliStrom

Highly flexible stranded wire with reinforced insulation. Super-fine Cu strand.

Typical Application

Current feeds and earth/ground wires in machine, plant and accumulator construction.
Safety test leads carrying high currents.



Order No.	Type	Nominal cross section	Strand design	Weight of cable	Conductor diameter	Thickness insulation wall	Outer diameter	Rated voltage	Test voltage	Rated current	Certification marks	*Colours	
	SIL	mm ²	n x Ø mm	kg/km	mm	mm	mm	AC/DC V	AC V	A			
61.7611-□*	SILI-S 4,0	4.0	1036 x 0.07	55	3.0	1.2	5.4	AC 1000 DC 1500	10,000	42	UL ¹⁾ CE UK CB EAC	21 22 23 33	
61.7612-□*	SILI-S 6,0	6.0	1548 x 0.07	80	3.5	1.35	6.2	AC 1000 DC 1500	10,000	54		21 22 23 33	
61.7613-□*	SILI-S 10	10	2556 x 0.07	145	4.8	2.1	9.0	AC 1000 DC 1500	14,000	75		21 22 23 33	
61.7614-□*	SILI-S 16	16	4116 x 0.07	230	6.1	2.2	10.5	AC 1000 DC 1500	14,000	100		21 22 23 33	
61.7615-□*	SILI-S 25	25	6384 x 0.07	310	7.0	2.4	11.8	AC 1000 DC 1500	16,000	130		21 22 23 33	
61.7616-□*	SILI-S 35	35	9324 x 0.07	440	8.5	2.4	13.3	AC 1000 DC 1500	16,000	160		33	
61.7617-□*	SILI-S 50	50	13024 x 0.07	570	10.5	2.5	14.9	AC 1000 DC 1500	16,000	200		33	
61.7618-□*	SILI-S 70	70	8967 x 0.10	760	12	2.2	16.4	AC 1000 DC 1500	14,000	245		CE	33
61.7619-□*	SILI-S 95	95	12103 x 0.10	1080	15	2.0	19	AC 1000 DC 1500	14,000	290		UK CB EAC	33

¹⁾ UL recognized: File E120880, AWM
Application: FLEXI up to 75 °C; PLAST and SILI up to 105 °C as measurement strand.

High Voltage Wires

FlexiVolt-HV FlexiPlast-HV

Highly flexible, reinforced insulated stranded wires. Super-fine Cu strand, bright-soft, tightly twisted.

- FlexiVolt-HV (type FLEXI-HV 0,75): with double-layer insulation (inside natural, outside coloured).

- FlexiPlast-HV (type PLAST-HV 0,5 SN): tin-plated strands, chlorine-free, double-layer insulation (inside natural, outside coloured).

Typical Application

Flexible high voltage wiring, hand-held test leads for high voltage tests.

FLEXI-HV 0,75



PLAST-HV 0,5 SN



Order No.	Type	Nominal cross section	Insulating material	Strand design	Weight of cable	Conductor diameter	Thickness insulation wall	Outer diameter	Rated voltage	Test voltage	Rated current	Certification marks	*Colours
		mm ²		n x Ø mm	kg/km	mm	mm	mm	AC V	AC V	A		
60.7067-□*	FLEXI-HV 0.75	0.75	PVC	196 x 0.07	33	1.25	1.9	5.1	10.000	20.000	15		22
60.7460-□*	PLAST-HV 0.5 SN	0.50	TPE	129 x 0.07	26	0.80	2.1	5.0	5000 ¹⁾	10.000	10	R ²⁾	21 22 23

¹⁾ As hand-held test lead

²⁾ UL recognized: File E120880, AWM
Application: FLEXI up to 75 °C; PLAST and SILI up to 105 °C as measurement strand.

SiliVolt-HV

Super flexible, reinforced insulated stranded wire. Super-fine Cu strand, bright-soft, tightly twisted. Silicone insulation, halogen-free and therefore environment-friendly.

Typical Application

Flexible high voltage wiring, hand-held test leads for high voltage tests.



Order No.	Type	Nominal cross section	Strand design	Weight of cable	Conductor diameter	Thickness insulation wall	Outer diameter	Rated voltage	Test voltage	Rated current	Certification marks	*Colours
	SIL	mm ²	n x Ø mm	kg/km	mm	mm	mm	AC V	AC/DC V	A		
61.7630-□*	SILI-HV 0,5	0.50	129 x 0.07	20	0.90	1.65	4.2	2500 ¹⁾ / 5000 ²⁾	AC 10,000	10		21 22
61.7631-□*	SILI-HV 0,75	0.75	196 x 0.07	29	1.25	1.9	5.1	3800 ¹⁾ / 7500 ²⁾	AC 15,000	15		21 22
61.7632-□*	SILI-HV 1,0	1.0	259 x 0.07	35	1.4	2.05	5.5	5000 ¹⁾ / 10000 ²⁾	AC 20,000	19		21 22
61.7634-□*	SILI-HV 2,5	2.5	651 x 0.07	58	2.3	2.15	6.6	6300 ¹⁾ / 12500 ²⁾	AC 25,000	32		21 22
61.7639-□*	SILI-HV 2,5/9	2.5	651 x 0.07	93	2.3	3.35	9.0	30000 ²⁾	DC 60,000	32		22
61.7636-□*	SILI-HV 6,0	6.0	1548 x 0.07	120	3.5	2.75	9.0	20000 ²⁾	DC 40,000	54		22

¹⁾ As hand-held test lead

²⁾ With wiring

Twin Wires

FLEXI-ZW SILI-ZW PLAST-ZW

Twin wires with single insulated wires in a black jacket. Super-fine Cu strand, bright-soft, tightly twisted. Insulations in PVC, silicone or TPE.

Typical Application

Highly flexible, two-pole test leads.

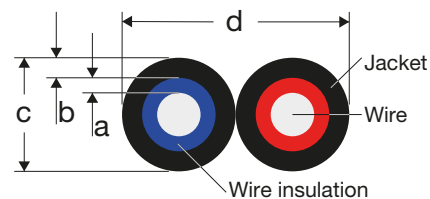
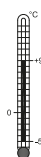

Order No.	Type	Nominal cross section	Insulating material	Strand design	Weight of cable	Conductor diameter	Thickness insulation wall	Outer dimensions	Rated voltage	Test voltage	Nominal current	Certification marks	* Colours
	PVC / SIL / TPE	mm ²		n x Ø mm	kg/km	mm	a + b mm	c x d mm	AC/DC V	AC V	A		
60.7453-□*	FLEXI-ZW 0,75	2 x 0.75	PVC	196 x 0.07	35	1.25	0.45 + 0.6	3.4 x 6.9	AC 1000 DC 1500	10,000	12	CE	21
60.7456-□*	FLEXI-ZW 2,0	2 x 2.0	PVC	525 x 0.07	62	2.0	0.45 + 0.5	3.9 x 7.9	AC 1000 DC 1500	10,000	24	UK CA EAC	21
61.7729-□*	SILI-ZW 0,25	2 x 0.25	SIL	129 x 0.05	11	0.70	0.25 + 0.4	2.0 x 4.1	300	5000	6	RU ¹⁾	21
61.7730-□*	SILI-ZW 0,5	2 x 0.5	SIL	129 x 0.07	29	0.90	0.65 + 0.6	3.4 x 6.9	AC 1000 DC 1500	10,000	10	CE	21
61.7731-□*	SILI-ZW 0,75	2 x 0.75	SIL	196 x 0.07	32	1.25	0.45 + 0.6	3.4 x 6.9	AC 1000 DC 1500	10,000	12	UK CA EAC	21
62.7473-□*	PLAST-ZW 0,75	2 x 0.75	TPE	196 x 0.07	32	1.25	0.45 + 0.6	3.4 x 6.9	AC 1000 DC 1500	10,000	12	CE UK CA EAC	21

¹⁾ UL recognized: File E120880, AWM
Application: FLEXI up to 75 °C; PLAST and SILI up to 105 °C as measurement strand.

Special Wires for Potential Equalization

FLEXI-S/POAG-HK

Highly flexible, reinforced insulated stranded wire. Green-yellow insulation. Super-fine strand, bright-soft, tightly twisted.

Typical Application

Potential equalization, e.g. in the medical engineering field.

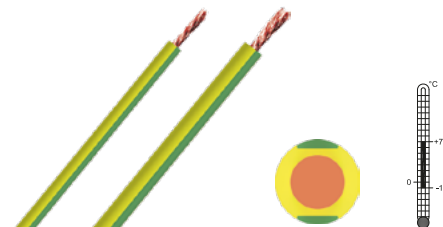

Order No.	Type	Nominal cross section	Strand design	Weight of cable	Conductor diameter	Thickness insulation wall	Outer diameter	Rated voltage	Test voltage	Rated current	Certification marks	* Colours
	PVC	mm ²	n x Ø mm	kg/km	mm	mm	mm	V	AC V	A		
15.2010-□20	FLEXI-S/POAG-HK4	4.0	1036 x 0.07	52	3.0	0.90	4.8	600	7000	42		20
15.2015-□20	FLEXI-S/POAG-HK6	6.0	1548 x 0.07	80	3.7	1.1	5.9	600	7000	54		20

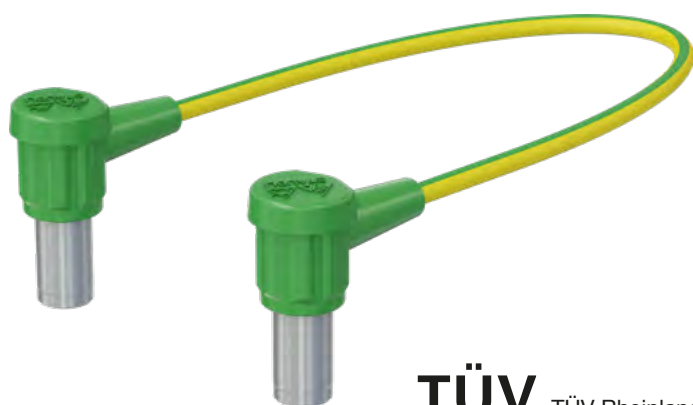

TÜV TÜV Rheinland LGA Products GmbH

Connectors for potential equalization – TÜV tested:
See main catalogue “Medical Technology”

Shielded Wires

RG58-PVC Silishield

Shielded, highly flexible coaxial cable. Insulations in PVC or silicone in various colours.

- Type RG58-PVC: Standard cable RG58. Inner core and shield mesh in tinned copper. Core insulation PE, outer insulation soft PVC.

- Silishield (Type SILI-SC 0,5/1,0): Ultra-flexible coaxial cable. Inner core stranded Cu, shield Cu mesh. Core insulation and outer insulation silicone with high temperature resistance.

RG58-PVC

SILI-SC 0,5/1,0

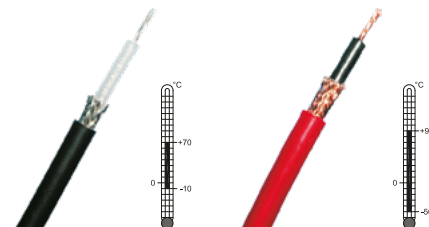

Order No.	Type	Lead Insulation	Nom. cross section inner wire	Design inner wire	Diameter inner wire	Design shield	Weight of cable	Thickness insulation wall	Outer diameter	Rated voltage	Earth / Shield	Wire / Shield	Impedance	Certification marks	*Colours
			mm ²	n x Ø mm	mm	n x Ø mm	kg/km	a mm b mm	mm	AC/DC V	AC V	AC V	Ω		
60.7500-□*	RG58-PVC	PVC	0.50	19 x 0.18	0.90	16 x 5 x 0.127	37	1.0 0.60	5.0	AC 1000 DC 1500	7000	3200	50	 	<div style="display: flex; gap: 5px;"> <div style="background-color: black; color: white; padding: 2px;">21</div> <div style="background-color: red; color: white; padding: 2px;">22</div> <div style="background-color: blue; color: white; padding: 2px;">23</div> </div>
61.7580-□*	SILI-SC 0,5/1,0	SIL	0.50	256 x 0.05	0.90	16 x 8 x 0.10	29	1.0 0.75	4.9	AC 1000 DC 1500	10,000	3200	~ 45	 	<div style="display: flex; gap: 5px;"> <div style="background-color: black; color: white; padding: 2px;">21</div> <div style="background-color: red; color: white; padding: 2px;">22</div> <div style="background-color: grey; color: white; padding: 2px;">28</div> </div>

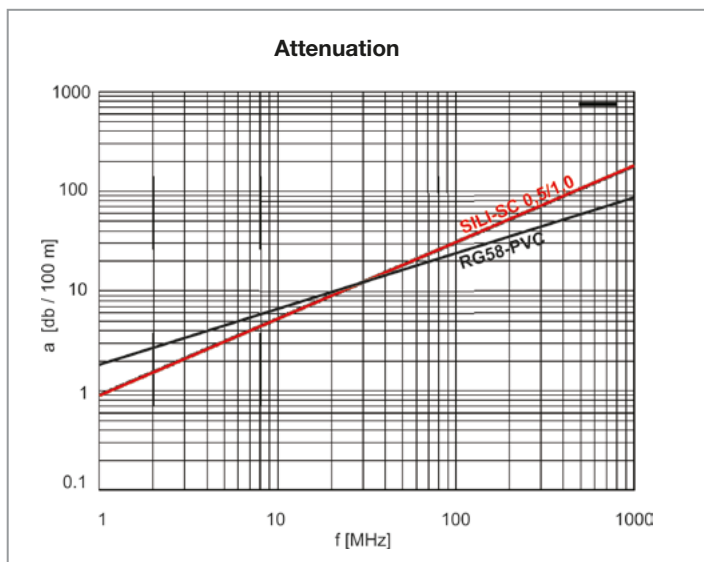
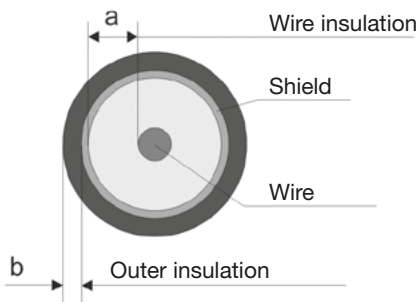

¹⁾ UL recognized: File E120880.
Application: Style 12020 PVC up to +75°C
Style 12021 silicone up to +105°C

Technical Information

Smallest Permissible Bend Radii

VDE 0298, part 3, stipulates minimum permissible bend radii of leads. In the following table, the minimum bend radii are shown

for fixed and mobile flexible leads at various rated voltages and outside diameters.

Rated voltage	≤ 600V				> 600V
	Outer diameter				
Flexible wire	≤ 8 mm	> 8 ... 12 mm	> 12 ... 20 mm	> 20 mm	
Fixed	3 d	3 d	4 d	4 d	6 d
Mobile	3 d	4 d	5 d	5 d	10 d

d = Outside diameter of lead

Why tinned multistrand copper wires?

If bright-soft copper stranded wires are exposed to temperatures > 90 °C, this can result in discoloration of the copper and an impairment of its soldering properties. Reactions between the copper and the insulating material may also occur which have a

deleterious effect on the mechanical properties of the flexible leads.

To avoid problems of this kind, we recommend using our tinned multistrand wires. These are suitable for continuous use at temperatures up to +150 °C with silicone insulation.

Resistance of conductor at 20 °C for class 5 Cu conductors

The following table shows the conductor resistance for fine-stranded copper wires with

bare individual strands at 20 °C in relation to the nominal cross-section according to DIN VDE 0295 (IEC 60228).

Nominal cross section	Conductor resistance
mm ²	Ω / km
0,50	39.0
0,75	26.0
1,0	19.5
1,50	13.3
2,5	7.98
4,0	4.95
6,0	3.30
10	1.91
16	1.21
25	0.780

Nominal cross section	Conductor resistance
mm ²	Ω / km
35	0.554
50	0.386
70	0.272
95	0.206
120	0.161
150	0.129
185	0.106
240	0.0801
300	0.0641

UL Approval

A number of our multistrand wires have a UL approval. This means that these articles

are approved as "Test Probe Wire". UL-approved wires are indicated in the catalogue with the .

Temperature-dependence of current-carrying capacity

VDE 0298, part 4, gives recommendations for the current-carrying capacity of leads. The following curves show the correlation between the current-carrying capacity of flexible

leads and the ambient temperature. 100 % corresponds to the rated current stated in the catalogue. The graph shows the curves for soft stranded copper wires with PVC, TPE and silicone insulation, and for tinned stranded copper wires (TPE-SN and SIL-SN).

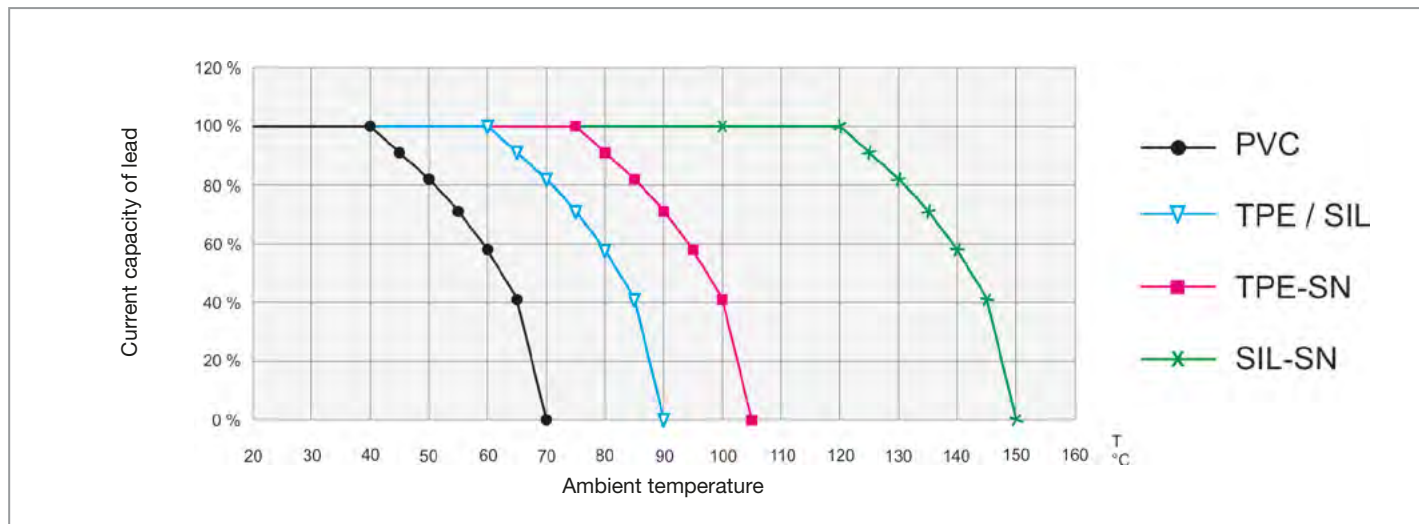
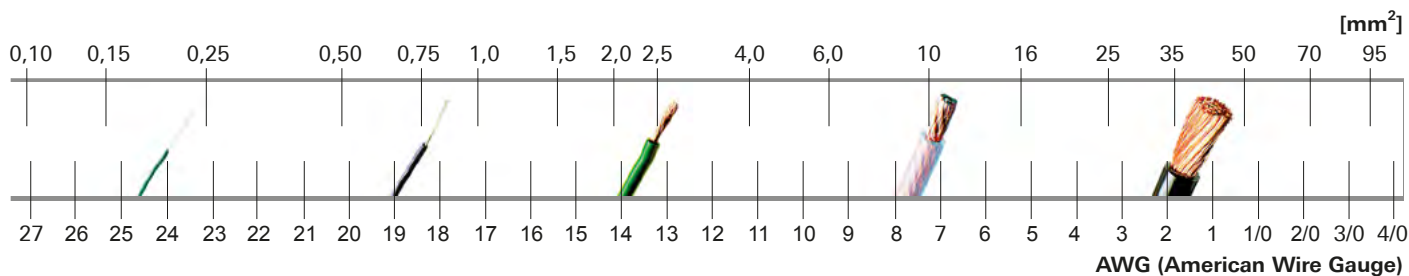

Table mm² / AWG

In the catalogue, the nominal cross-section of our multistrand wires is stated in sq. mm.

The following chart gives an indication of their comparability with corresponding AWG values.¹⁾



¹⁾ The chart is based on values for stranded wires given in UL 758 "UL Standard for Safety for Appliance Wiring Material".

Technical Modifications and Information Given in the Catalogue

We have a policy of continuous improvement and reserve the right to make technical modifications to any product in accordance with any safety and technical developments. We accept no responsibility for the accuracy of the information given in the catalogue.

APPENDIX

Index

Sort by type

Type	Page
FLEXI-1V 0,50	10
FLEXI-1V 0,75	10
FLEXI-1V 1,0	10
FLEXI-1V 1,5	10
FLEXI-1V 2,5	10
FLEXI-2V 0,25	11
FLEXI-2V 0,50	11
FLEXI-2V 0,75	11
FLEXI-2V 1,0	11
FLEXI-2V 1,5	11
FLEXI-2V 2,5	11
FLEXI-2V 4,0	11
FLEXI-2V 6,0	11
FLEXI-2V/HK 0,75-D	11
FLEXI-2V/HK 2,5-D	11
FLEXI-E 0,10	9
FLEXI-E 0,15	9
FLEXI-E 0,25	9
FLEXI-E 0,50	9
FLEXI-E 0,75	9
FLEXI-E 1,0	9
FLEXI-E 1,5	9
FLEXI-E 2,5	9
FLEXI-E/HK 0,25	9
FLEXI-E/HK 0,50	9
FLEXI-E/HK 1,0	9
FLEXI-HV 0,75	21
FLEXI-S 4,0	12
FLEXI-S 6,0	12
FLEXI-S 10	12
FLEXI-S 16	12
FLEXI-S 25	12
FLEXI-S/POAG-HK4	24
FLEXI-S/POAG-HK6	24
FLEXI-ZW 0,75	23
FLEXI-ZW 2,0	23
PLAST-1V 0,50 SN	14
PLAST-1V 2,5	14
PLAST-1V 2,5 SN	14
PLAST-2V 0,25	15
PLAST-2V 0,50	15
PLAST-2V 2,0	15

Type	Page
PLAST-2V 2,5	15
PLAST-E 0,15	14
PLAST-E 0,25	14
PLAST-E 0,50	14
PLAST-E 0,75	14
PLAST-E 1,0	14
PLAST-E 2,5	14
PLAST-HV 0,5 SN	21
PLAST-ZW 0,75	23
RG58-PVC	25
SILI-1V 0,15	18
SILI-1V 0,25	18
SILI-1V 0,50	18
SILI-1V 0,50 SN	18
SILI-1V 0,75	18
SILI-1V 0,75/3,2	18
SILI-1V 1,0	18
SILI-1V 1,0 SN	18
SILI-1V 1,5	18
SILI-1V 2,5	18
SILI-2V 0,50	19
SILI-2V 0,75	19
SILI-2V 1,0	19
SILI-2V 2,5	19
SILI-E 0,15	17
SILI-E 0,25	17
SILI-E 0,50	17
SILI-E 0,50 SN	17
SILI-E 0,75	17
SILI-E 1,0	17
SILI-E 1,5	17
SILI-E 2,5	17
SILI-E 2,5 SN	17
SILI-HV 0,5	22
SILI-HV 0,75	22
SILI-HV 1,0	22
SILI-HV 2,5	22
SILI-HV 2,5/9	22
SILI-HV 6,0	22
SILI-S 4,0	20
SILI-S 6,0	20
SILI-S 10	20

Type	Page
SILI-S 16	20
SILI-S 25	20
SILI-S 35	20
SILI-S 50	20
SILI-S 70	20
SILI-S 95	20
SILI-SC 0,5/1,0	25
SILI-ZW 0,5	23
SILI-ZW 0,25	23
SILI-ZW 0,75	23

Sort by order no.

Order no.	Page
60.7085-*	10
60.7086-*	10
60.7087-*	10
60.7088-*	10
60.7125-*	10
60.7026-*	11
60.7027-*	11
60.7028-*	11
60.7030-*	11
60.7031-*	11
60.7032-*	11
60.7034-*	11
60.7035-*	11
60.7941-*	11
60.7033-*	11
60.7001-*	9
60.7002-*	9
60.7003-*	9
60.7004-*	9
60.7006-*	9
60.7008-*	9
60.7010-*	9
60.7012-*	9
60.7013-*	9
60.7005-*	9
60.7009-*	9
60.7067-*	21
60.7014-*	12
60.7015-*	12
60.7017-*	12
60.7018-*	12
60.7020-*	12
15.2010-20	24
15.2015-20	24
60.7453-*	23
60.7456-*	23
60.7763-*	14
60.7230-*	14
60.7768-*	14
60.7240-*	15
60.7245-*	15
60.7265-*	15

Order no.	Page
60.7270-*	15
60.7170-*	14
60.7175-*	14
60.7180-*	14
60.7185-*	14
60.7190-*	14
60.7200-*	14
60.7460-*	21
62.7473-*	23
60.7500-*	25
61.7603-*	18
61.7604-*	18
61.7605-*	18
61.7642-*	18
61.7606-*	18
61.7122-*	18
61.7607-*	18
61.7644-*	18
61.7608-*	18
61.7610-*	18
61.7662-*	19
61.7663-*	19
61.7664-*	19
61.7667-*	19
61.7550-*	17
61.7551-*	17
61.7552-*	17
61.7532-*	17
61.7553-*	17
61.7554-*	17
61.7555-*	17
61.7556-*	17
61.7537-*	17
61.7630-*	22
61.7631-*	22
61.7632-*	22
61.7634-*	22
61.7639-*	22
61.7636-*	22
61.7611-*	20
61.7612-*	20
61.7613-*	20

Order no.	Page
61.7614-*	20
61.7615-*	20
61.7616-*	20
61.7617-*	20
61.7618-*	20
61.7619-*	20
61.7580-*	25
61.7730-*	23
61.7729-*	23
61.7731-*	23



● Stäubli Units ○ Representatives/Agents

Global presence of the Stäubli Group

www.staubli.com