

TINA-Y-WWW

~75° wide beam. Assembly with holder, installation tape and pins.

SPECIFICATION:

Dimensions	Ø 16.1
Height	10 mm
Fastening	tape, pin
ROHS compliant	yes ⓘ



MATERIALS:

Component	Type	Material	Colour	Finish	Length (mm)
TINA-Y-WWW	Single lens	PMMA	clear	gloss	
TINA-Y-HLD	Holder	PC	black	gloss	
TINA-Y-TAPE	Tape	Acryl tape			

ORDERING INFORMATION:

Component	Qty in box	MOQ	MPQ	Box weight (kg)
CA19888_TINA-Y-WWW » Box size: 476 x 273 x 197 mm	3900	300	300	6.1

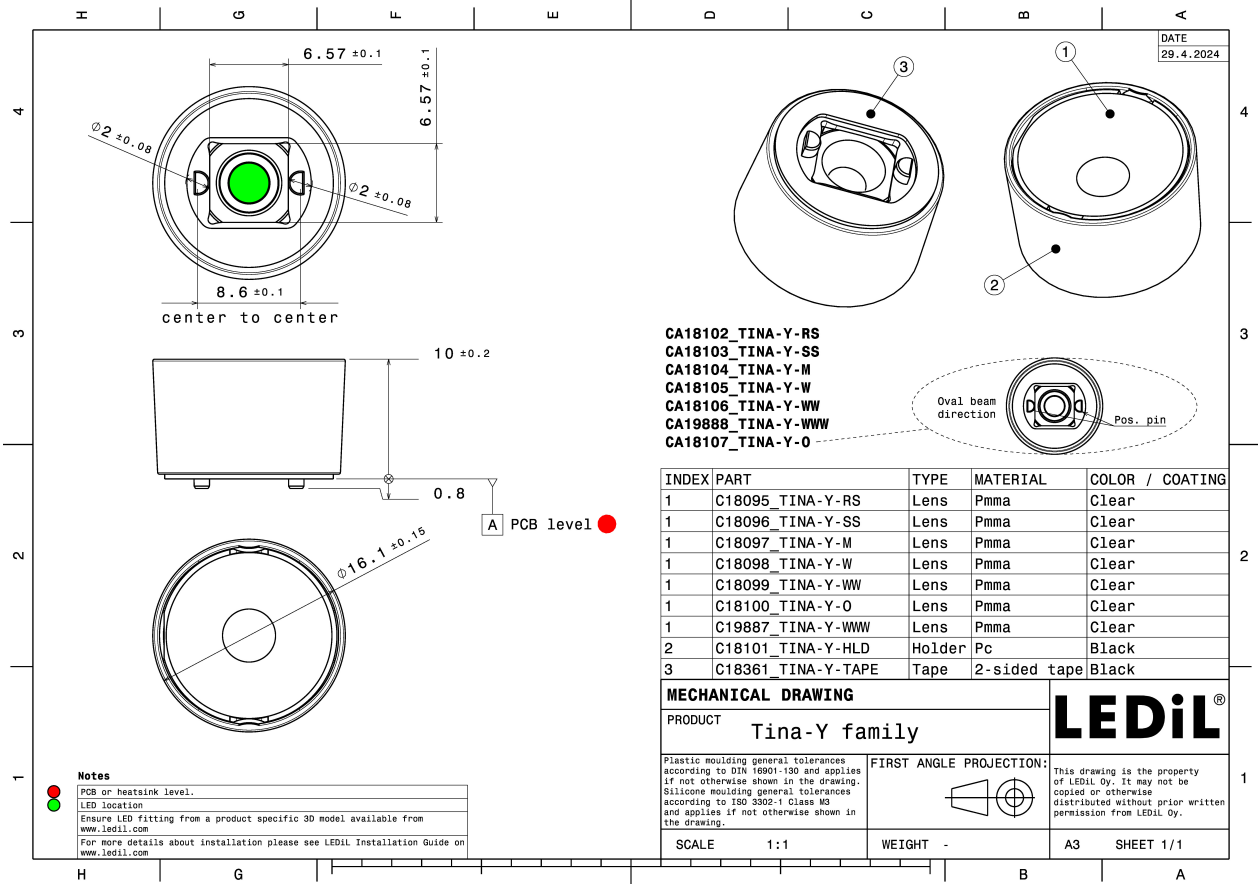

See also our general installation guide: www.ledil.com/installation_guide

OPTICAL RESULTS (MEASURED):

SAMSUNG

LED LM301B
FWHM / FWTM 68.0° / 92.0°
Efficiency 85 %
Peak intensity 0.7 cd/lm
LEDs/each optic 1
Light colour/type White
Required components:

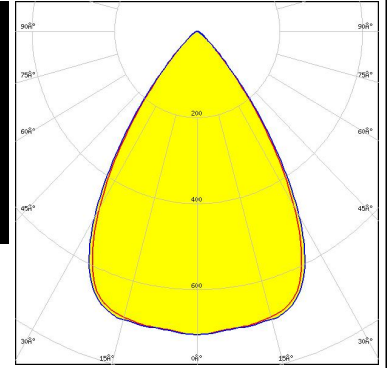
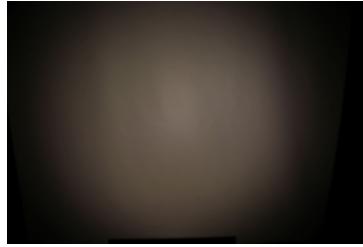

Light distribution files

OPTICAL RESULTS (SIMULATED):



LED JB3030 HE B Class
 FWHM / FWTM 68.0° / 96.0°
 Efficiency 83 %
 Peak intensity 0.7 cd/lm
 LEDs/each optic 1
 Light colour/type White
 Required components:

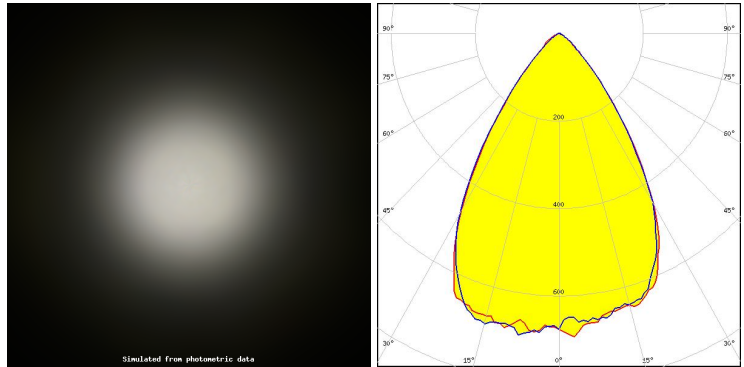

Light distribution files



LED XM-L2
 FWHM / FWTM 77.0° / 105.0°
 Efficiency 81 %
 Peak intensity 0.5 cd/lm
 LEDs/each optic 1
 Light colour/type White
 Required components:

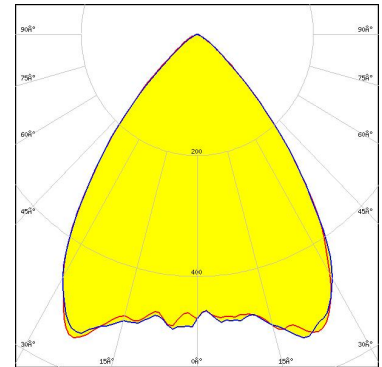

Light distribution files



LED XP-E2
 FWHM / FWTM 78.0° / 100.0°
 Efficiency 88 %
 Peak intensity 0.6 cd/lm
 LEDs/each optic 1
 Light colour/type White
 Required components:

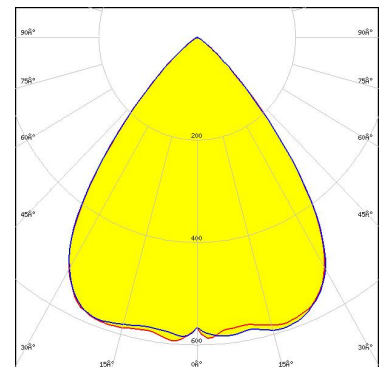

Light distribution files

OPTICAL RESULTS (SIMULATED):



LED XP-G3
FWHM / FWTM 76.0° / 101.0°
Efficiency 80 %
Peak intensity 0.5 cd/lm
LEDs/each optic 1
Light colour/type White
Required components:

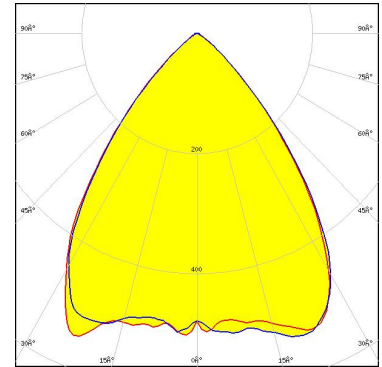

Light distribution files



LED XP-G4
FWHM / FWTM 78.0° / 103.0°
Efficiency 82 %
Peak intensity 0.6 cd/lm
LEDs/each optic 1
Light colour/type White
Required components:

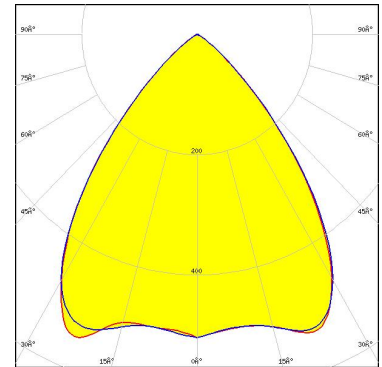

Light distribution files



LED LUXEON 5050 Round LES
FWHM / FWTM 68.0° / 106.0°
Efficiency 78 %
Peak intensity 0.6 cd/lm
LEDs/each optic 1
Light colour/type White
Required components:

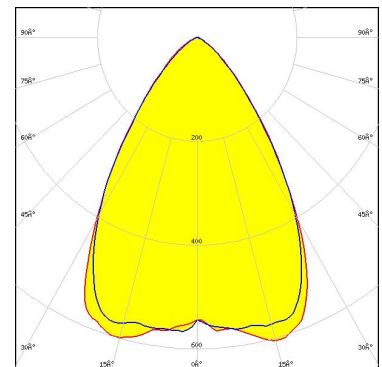

Light distribution files

OPTICAL RESULTS (SIMULATED):



LED LUXEON 5050 Square LES
FWHM / FWTM 69.0° / 106.0°
Efficiency 78 %
Peak intensity 0.6 cd/lm
LEDs/each optic 1
Light colour/type White
Required components:

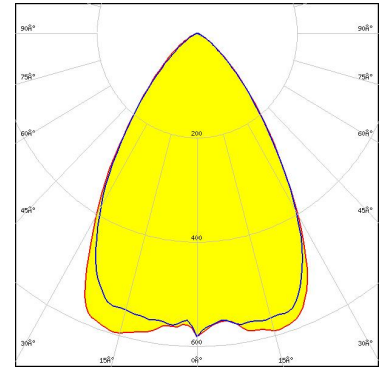

Light distribution files



LED LUXEON TX
FWHM / FWTM 75.0° / 100.0°
Efficiency 84 %
Peak intensity 0.6 cd/lm
LEDs/each optic 1
Light colour/type White
Required components:

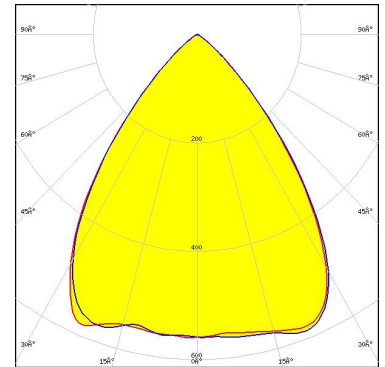

Light distribution files



LED NFSW757H
FWHM / FWTM 72.0° / 99.0°
Efficiency 86 %
Peak intensity 0.6 cd/lm
LEDs/each optic 1
Light colour/type White
Required components:

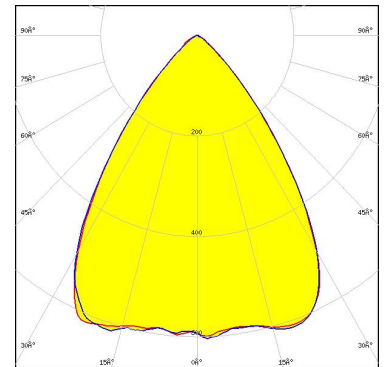

Light distribution files

OPTICAL RESULTS (SIMULATED):



LED NFSW757H
 FWHM / FWTM 74.0° / 99.0 + 100.0°
 Efficiency 86 %
 Peak intensity 0.6 cd/lm
 LEDs/each optic 1
 Light colour/type White
 Required components:

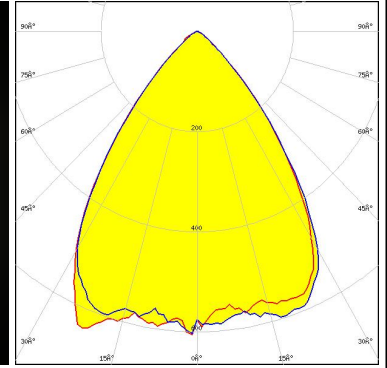
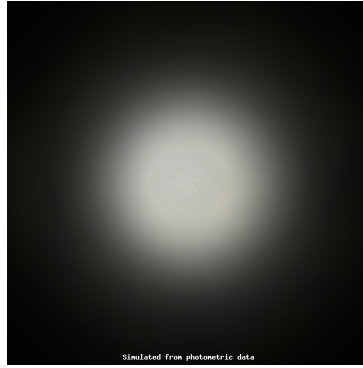

Light distribution files



LED OSOLON Signal
 FWHM / FWTM 76.0° / 100.0°
 Efficiency 88 %
 Peak intensity 0.6 cd/lm
 LEDs/each optic 1
 Light colour/type Blue
 Required components:

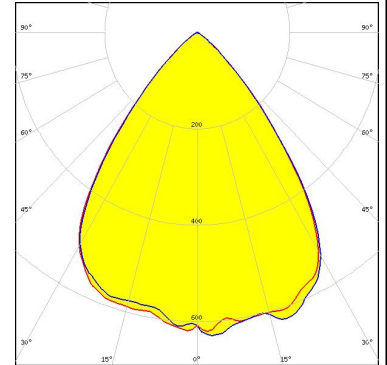

Light distribution files



LED OSOLON Square CSSRM2/CSSRM3
 FWHM / FWTM 78.0° / 103.0°
 Efficiency 83 %
 Peak intensity 0.6 cd/lm
 LEDs/each optic 1
 Light colour/type White
 Required components:

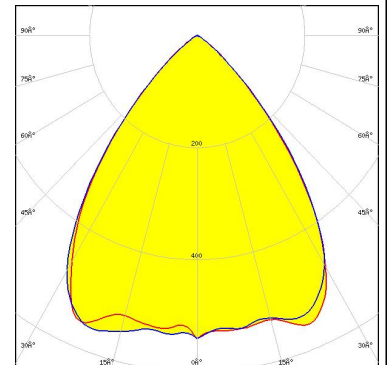

Light distribution files

OPTICAL RESULTS (SIMULATED):

OSRAM
Opto Semiconductors

LED OSLON SSL 150
FWHM / FWTM 80.0° / 101.0°
Efficiency 87 %
Peak intensity 0.6 cd/lm
LEDs/each optic 1
Light colour/type White
Required components:

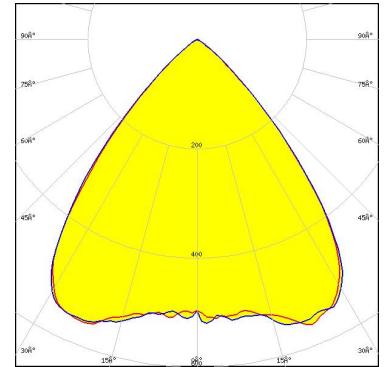

Light distribution files

OSRAM
Opto Semiconductors

LED OSLON SSL 80
FWHM / FWTM 67.0° / 98.0°
Efficiency 84 %
Peak intensity 0.8 cd/lm
LEDs/each optic 1
Light colour/type Blue
Required components:

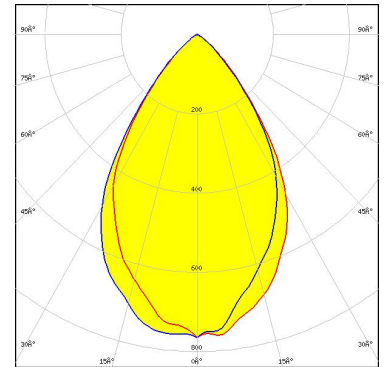

Light distribution files

OSRAM
Opto Semiconductors

LED OSLON SSL 80
FWHM / FWTM 67.0° / 100.0°
Efficiency 85 %
Peak intensity 0.7 cd/lm
LEDs/each optic 1
Light colour/type True Green
Required components:

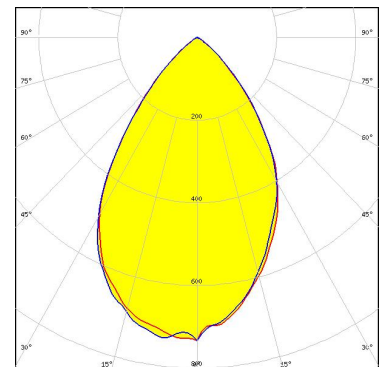

Light distribution files

OPTICAL RESULTS (SIMULATED):

OSRAM
Opto Semiconductors

LED OSLO[™] SSL 80
FWHM / FW_{TM} 71.0° / 100.0°
Efficiency 85 %
Peak intensity 0.7 cd/lm
LEDs/each optic 1
Light colour/type White
Required components:

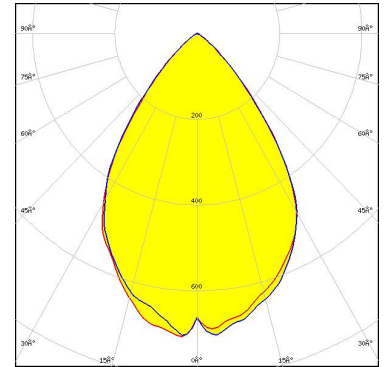

Light distribution files

OSRAM
Opto Semiconductors

LED OSLO[™] SSL 80
FWHM / FW_{TM} 67.0° / 100.0°
Efficiency 84 %
Peak intensity 0.8 cd/lm
LEDs/each optic 1
Light colour/type True Green
Required components:

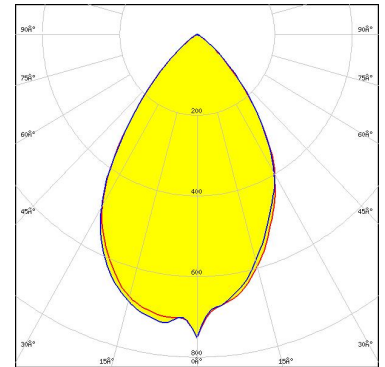

Light distribution files

OSRAM
Opto Semiconductors

LED OSLO[™] SSL 80
FWHM / FW_{TM} 70.0° / 99.0°
Efficiency 86 %
Peak intensity 0.7 cd/lm
LEDs/each optic 1
Light colour/type White
Required components:

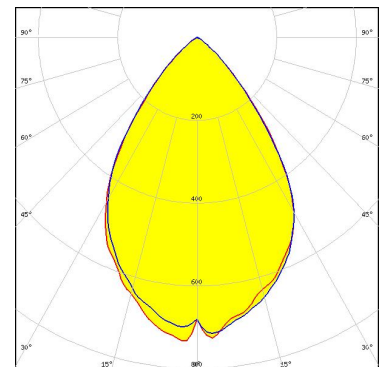

Light distribution files

OPTICAL RESULTS (SIMULATED):

OSRAM
Opto Semiconductors

LED OSLON SSL 80
FWHM / FWTM 66.0° / 98.0°
Efficiency 85 %
Peak intensity 0.8 cd/lm
LEDs/each optic 1
Light colour/type Red
Required components:

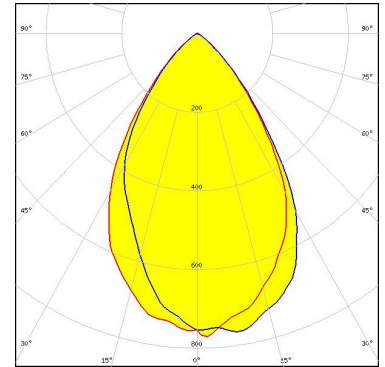

Light distribution files

OSRAM
Opto Semiconductors

LED OSLON SSL 80
FWHM / FWTM 65.0° / 98.0°
Efficiency 84 %
Peak intensity 0.8 cd/lm
LEDs/each optic 1
Light colour/type Red
Required components:

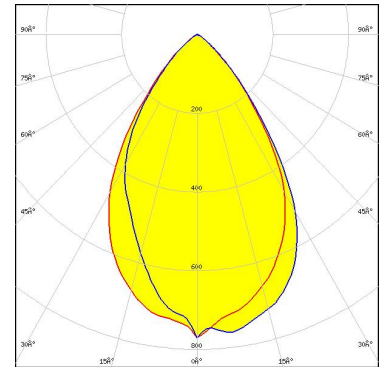

Light distribution files

OSRAM
Opto Semiconductors

LED SFH 4715AS
FWHM / FWTM 62.0° / 93.0°
Efficiency 86 %
LEDs/each optic 1
Light colour/type White
Required components:

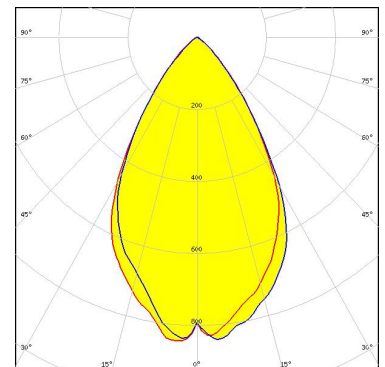

Light distribution files

OPTICAL RESULTS (SIMULATED):

SAMSUNG

LED LH351B
FWHM / FWTM 77.0° / 104.0°
Efficiency 83 %
Peak intensity 0.6 cd/lm
LEDs/each optic 1
Light colour/type White
Required components:

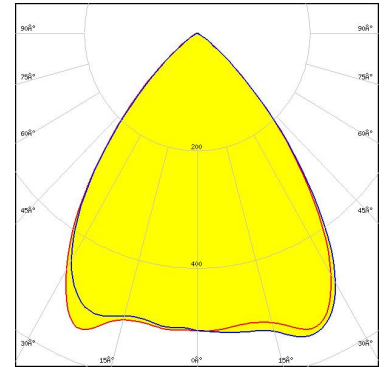

Light distribution files

SAMSUNG

LED LM28xB Series
FWHM / FWTM 71.0° / 98.0°
Efficiency 85 %
Peak intensity 0.7 cd/lm
LEDs/each optic 1
Light colour/type White
Required components:

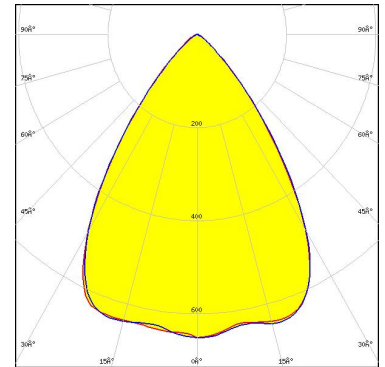

Light distribution files

SAMSUNG

LED LM301B
FWHM / FWTM 73.0° / 99.0°
Efficiency 86 %
Peak intensity 0.6 cd/lm
LEDs/each optic 1
Light colour/type White
Required components:

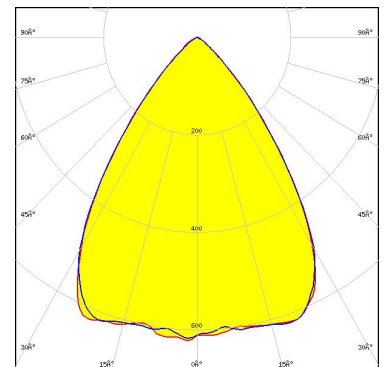

Light distribution files

GENERAL INFORMATION:

NOTE: The typical beam angle will be changed by different color, chip size and chip position tolerance. The typical total beam angle is the full angle measured where the luminous intensity is half of the peak value.

MATERIALS:

As part of our continuous research and improvement processes, and to ensure the best possible quality and availability of our products, LEDiL reserves the right to change material grades without notice.

PRODUCT DATA USER AGREEMENT AND DISCLAIMER:

The measured data in the provided downloadable LEDiL Product Datasheets and Mechanical 2D-Drawings is rounded and provided as reference for planning. LEDiL Oy's optical specifications have been verified by conducting performance testing of the products in accordance with the company's quality system. The reported data are averaged results of multiple measurements with typical variation. LEDiL Oy reserves the right to without prior notification make changes and improvements to its products.

LEDiL Oy assumes neither warranty, nor guarantee nor any other liability of any kind for the contents and correctness of the provided data. The provided data has been generated with highest diligence but the provided data may in reality not represent the complete possible variation range of all intrinsic parameters. Therefore, in certain cases a deviation from the provided data could occur.

LEDiL Oy reserves the right to undertake technical changes of its products without further notification which could lead to changes in the provided data. LEDiL Oy assumes no liability of any kind for the possible deviation from any provided data or any other damage resulting from the usage of the provided data.

The user agrees to this disclaimer and user agreement with the download or usage of the provided files.

LEDiL Oy

Joensuunkatu 7
FI-24100 SALO
Finland

LEDiL Inc.

228 West Page Street
Suite D
Sycamore IL 60178
USA

Ledil Optics Technology (Shenzhen) Co., Ltd.

405 , Block B
Casic Motor Building
Shenzhen 518057
P.R.CHINA

Local sales and technical support

[www.ledil.com/
where_to_buy](http://www.ledil.com/where_to_buy)

Shipping locations

Poznan, Poland
Hong Kong, China

Distribution Partners

[www.ledil.com/
where_to_buy](http://www.ledil.com/where_to_buy)