

XLamp® CMU1526 LED



PRODUCT DESCRIPTION

The XLamp® CMU LED family delivers industry-leading performance in commonly-available package and LES sizes. The CMU family delivers up to 10% higher LPW than the previous generation CMT family while retaining mechanical and optical compatibility with CMT. XLamp CMU LEDs are optimized for premium indoor lighting applications, including track, spot and downlight, as well as outdoor lighting.

FEATURES

- 14.5-mm optical source
- Available in 70-, 80-, 90-, and 95-minimum CRI options
- EasyWhite® 2-, 3- and 5-step binning
- Premium Color 2- and 3-step binning
- Forward voltage option: 36-V class
- 85 °C binning and characterization
- Maximum drive current: 1920 mA
- 115° viewing angle, uniform chromaticity profile
- Top-side solder connections
- RoHS and REACH compliant
- UL® recognized component (E349212)



Cree LED / 4001 E. Hwy. 54, Suite 2000 / Durham, NC 27713 USA / +1.919.313.5330 / www.cree-led.com

TABLE OF CONTENTS

Characteristics	3
Operating Limits.....	3
Flux Characteristics, EasyWhite® Order Codes and Bins.....	4
Flux Characteristics, Premium Color Order Codes and Bins.....	5
Relative Spectral Power Distribution, EasyWhite® LEDs.....	6
Relative Spectral Power Distribution, Premium Color LEDs.....	7
Electrical Characteristics.....	9
Relative Luminous Flux.....	10
Relative Chromaticity vs. Current and Temperature	11
Typical Spatial Distribution.....	15
Performance Groups - Chromaticity.....	16
Premium Color Performance Groups - Chromaticity.....	17
EasyWhite® Bins Plotted on the 1931 CIE Color Space.....	18
Premium Color Bins Plotted on the 1931 CIE Color Space.....	19
Bin and Order Code Formats.....	21
Mechanical Dimensions	22
Thermal Design	23
Notes	24
Packaging.....	25

CHARACTERISTICS

Characteristics	Unit	Minimum	Typical	Maximum
Viewing angle (FWHM)	degrees		115	
ESD withstand voltage (JEDEC JS-001-2012)	V		Class 3A	
DC forward current	mA			1920*
Reverse current	mA			0.1
Forward voltage (@ 720 mA, 85 °C)	V		33.6	37.5
Forward voltage (@ 720 mA, 25 °C)	V		34.3	38.2

* Refer to the Operating Limits section.

OPERATING LIMITS

The maximum current rating of the CMU1526 LED depends on the case temperature (T_c) when the LED has reached thermal equilibrium under steady-state operation. The graph shown below assumes that the system design employs good thermal management (thermal interface material and heat sink) and may vary when poor thermal management is employed. Either solder pad shown in the Mechanical Dimensions section on page 22 can be used as the T_c measurement point.

Another important factor in good thermal management is the temperature of the Light Emitting Surface (LES). Cree LED recommends a maximum LES temperature of 140 °C to ensure optimal LED lifetime. Please refer to the Thermal Design section on page 23 for more information on LES temperature measurement.

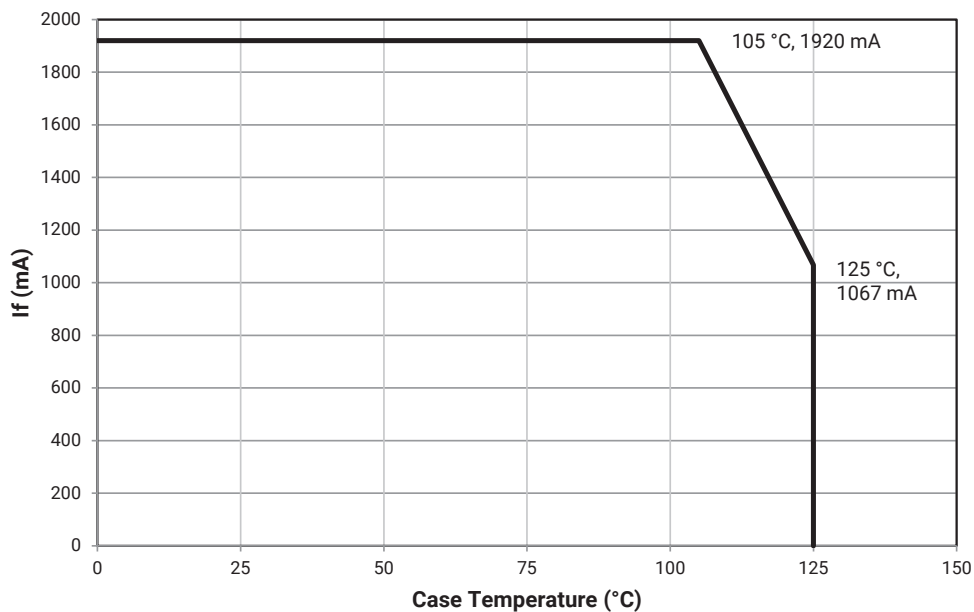

FLUX CHARACTERISTICS, EASYWHITE® ORDER CODES AND BINS (I_F = 720 mA, T_J = 85 °C)

The following table provides order codes for XLamp CMU1526 LEDs. For a complete description of the order code nomenclature, please see the Bin and Order Code Formats section (page 21).

Nominal CCT	CRI		Minimum Luminous Flux (lm)	Typical Luminous Flux (lm)	2-Step		3-Step		5-Step	
	Min.	Typ			Group	Order Code	Group	Order Code	Group	Order Code
6500 K	70	73	4153	4574					65E	CMU1526-0000-000N0B0A65E
	80	82	3786	4252			65G	CMU1526-0000-000N0H0A65G		
5700 K	70	73	4120	4539					57E	CMU1526-0000-000N0B0A57E
	80	82	3756	4219			57G	CMU1526-0000-000N0H0A57G		
	90	92	3305	3748			57G	CMU1526-0000-000N0U0A57G		
5000 K	70	73	4120	4539					50E	CMU1526-0000-000N0B0A50E
	80	82	3756	4219			50G	CMU1526-0000-000N0H0A50G		
	90	92	3262	3699			50G	CMU1526-0000-000N0U0A50G		
4000 K	70	73	4073	4530					40E	CMU1526-0000-000N0B0A40E
	80	82	3713	4211	40H	CMU1526-0000-000N0H0A40H	40G	CMU1526-0000-000N0H0A40G		
	90	92	3195	3623	40H	CMU1526-0000-000N0U0A40H	40G	CMU1526-0000-000N0U0A40G		
3500 K	80	82	3684	4138	35H	CMU1526-0000-000N0H0A35H	35G	CMU1526-0000-000N0H0A35G		
	90	92	3192	3585	35H	CMU1526-0000-000N0U0A35H	35G	CMU1526-0000-000N0U0A35G		
3000 K	70	73	3967	4370					30E	CMU1526-0000-000N0B0A30E
	80	82	3617	4102	30H	CMU1526-0000-000N0H0A30H	30G	CMU1526-0000-000N0H0A30G		
	90	92	3147	3501	30H	CMU1526-0000-000N0U0A30H	30G	CMU1526-0000-000N0U0A30G		
2700 K	80	82	3473	3939	27H	CMU1526-0000-000N0H0A27H	27G	CMU1526-0000-000N0H0A27G		
	90	92	3027	3335	27H	CMU1526-0000-000N0U0A27H	27G	CMU1526-0000-000N0U0A27G		
2200 K	80	82	3056	3433	22H	CMU1526-0000-000N0H0A22H	22G	CMU1526-0000-000N0H0A22G		
	90	92	2573	2835	22H	CMU1526-0000-000N0U0A22H	22G	CMU1526-0000-000N0U0A22G		

- Notes**
- Cree LED maintains a tolerance of ±7% on flux and power measurements, ±0.005 on chromaticity (CCx, CCy) measurements and a tolerance of ±2 on CRI measurements. See the Measurements section (page 24).
 - For 80 CRI minimum LEDs, CRI R9 minimum is 0 with a ±2 tolerance. For 90 CRI minimum LEDs, CRI R9 typical is 60.

FLUX CHARACTERISTICS, PREMIUM COLOR ORDER CODES AND BINS ($I_F = 720 \text{ mA}$, $T_J = 85 \text{ }^\circ\text{C}$)
Fidelity

Nominal CCT	CRI*		Minimum Luminous Flux (lm)	Typical Luminous Flux (lm)	2-Step	
	Min.	Typ			Group	Order Code
4000 K	95	98	2886	3365	40H	CMU1526-0000-000N0Z0A40H
3500 K	95	98	2871	3224	35H	CMU1526-0000-000N0Z0A35H
3000 K	95	98	2788	3160	30H	CMU1526-0000-000N0Z0A30H
2700 K	95	98	2654	2952	27H	CMU1526-0000-000N0Z0A27H

Specialty

Nominal CCT	CRI		Minimum Luminous Flux (lm)	Typical Luminous Flux (lm)	2-Step		3-Step			
	Min.	Typ			Group	Order Code	Group	Order Code	Group	Order Code
3100 K	90	92	3005	3441			31Q	CMU1526-0000-000N0U0A31Q		
3000 K	90	92	3084	3531			30Q	CMU1526-0000-000N0U0A30Q		
	90	92	2958	3387					30U	CMU1526-0000-000N0U0A30U
	95	98	2669	2922	L7C	CMU1526-0000-000N0Z0AL7C				

Notes

- Cree LED maintains a tolerance of $\pm 7\%$ on flux and power measurements, ± 0.005 on chromaticity (CCx, CCy) measurements and a tolerance of ± 2 on CRI measurements. See the Measurements section (page 24).
- For 80 CRI minimum LEDs, CRI R9 minimum is 0 with a ± 2 tolerance. For 90 CRI minimum LEDs, CRI R9 typical is 60.

RELATIVE SPECTRAL POWER DISTRIBUTION, EASYWHITE® LEDS

The following graphs are the result of a series of pulsed measurements at 720 mA and $T_j = 85\text{ }^\circ\text{C}$.

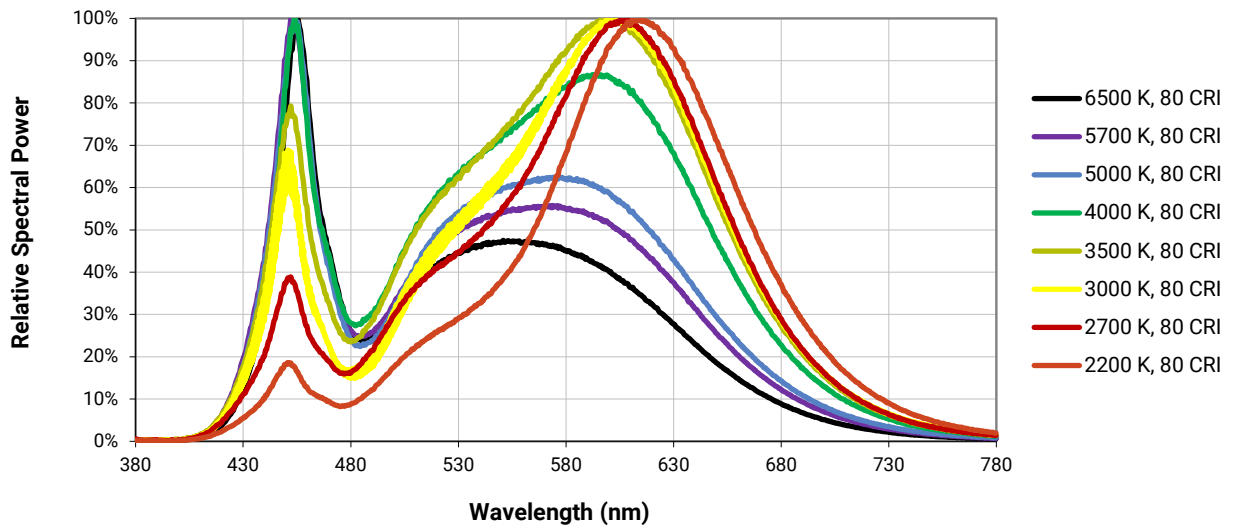
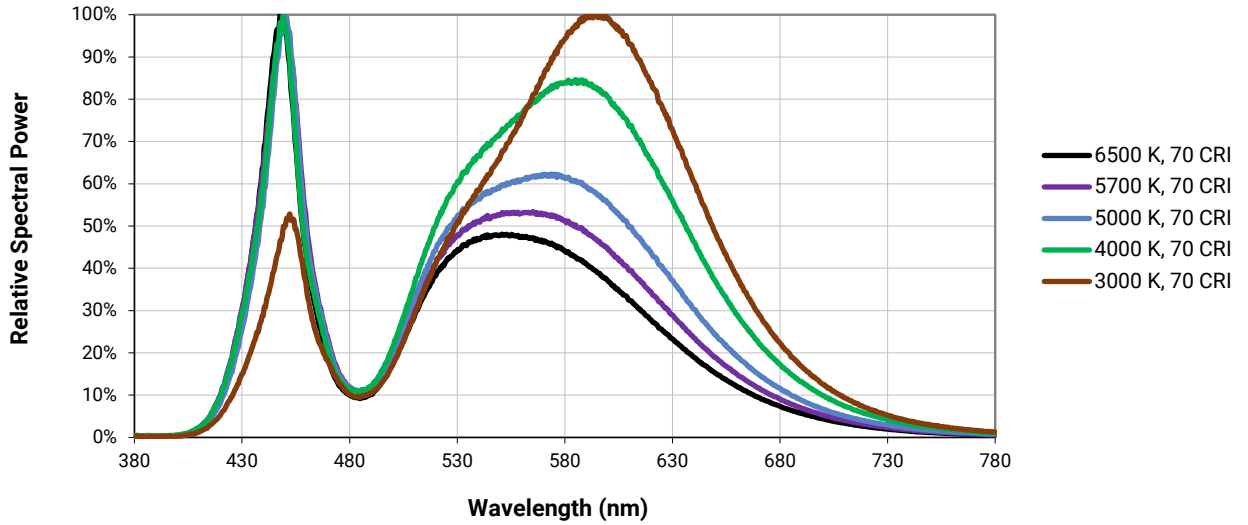

RELATIVE SPECTRAL POWER DISTRIBUTION, EASYWHITE® LEDS - CONTINUED

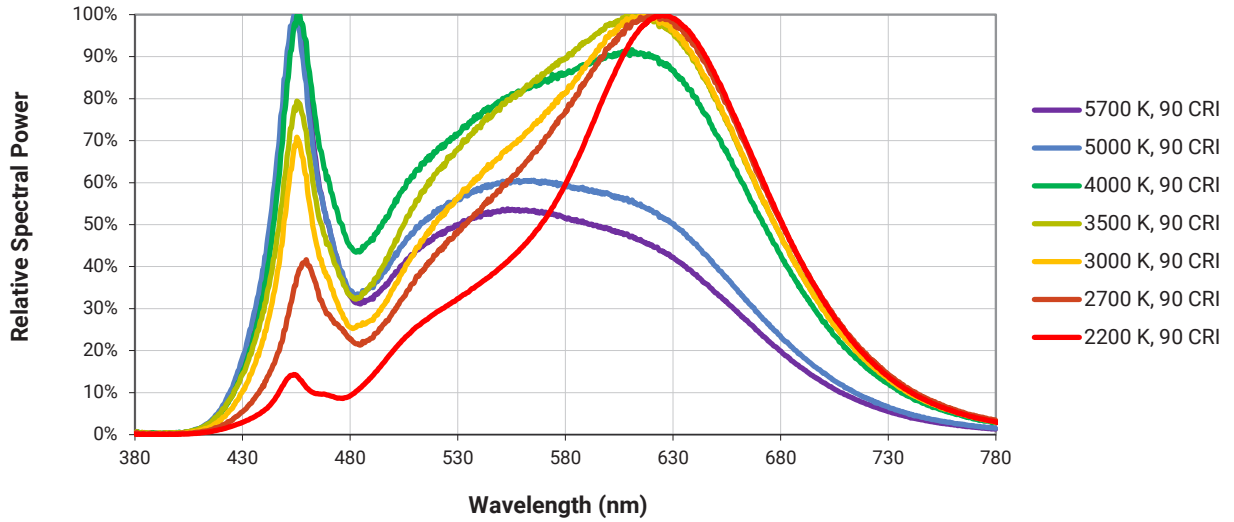

RELATIVE SPECTRAL POWER DISTRIBUTION, PREMIUM COLOR LEDS

The following graphs are the result of a series of pulsed measurements at 720 mA and $T_j = 85^\circ\text{C}$.

Fidelity

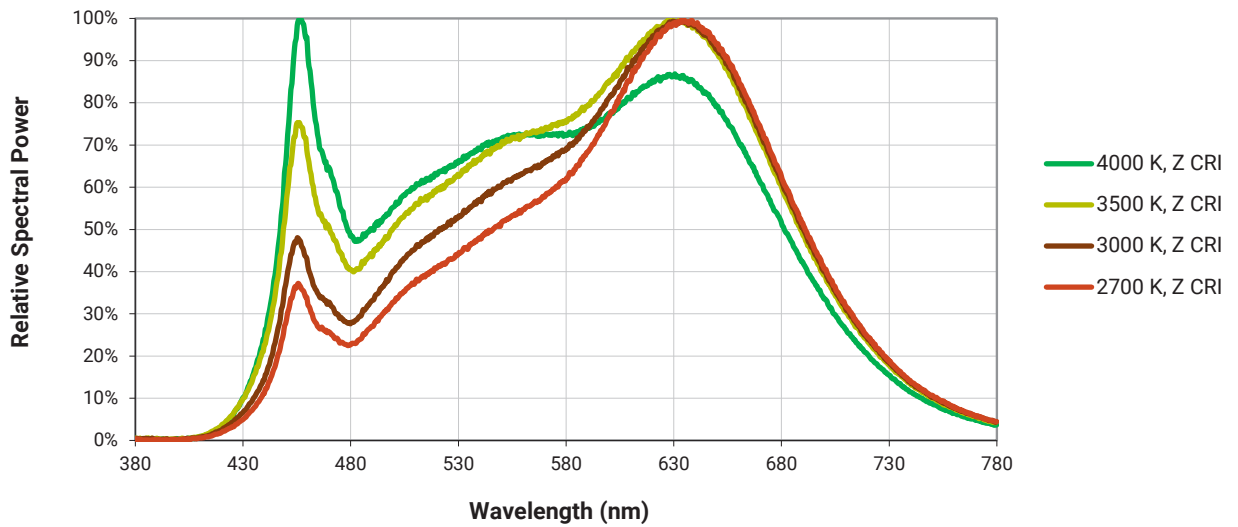

RELATIVE SPECTRAL POWER DISTRIBUTION, PREMIUM COLOR LEDS - CONTINUED

Specialty

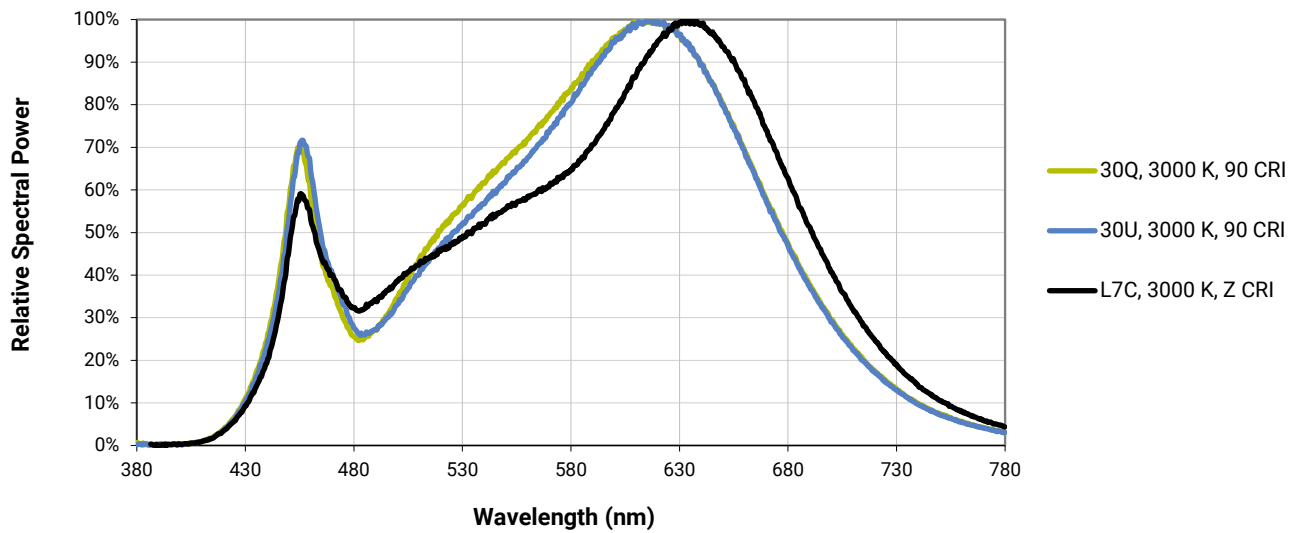
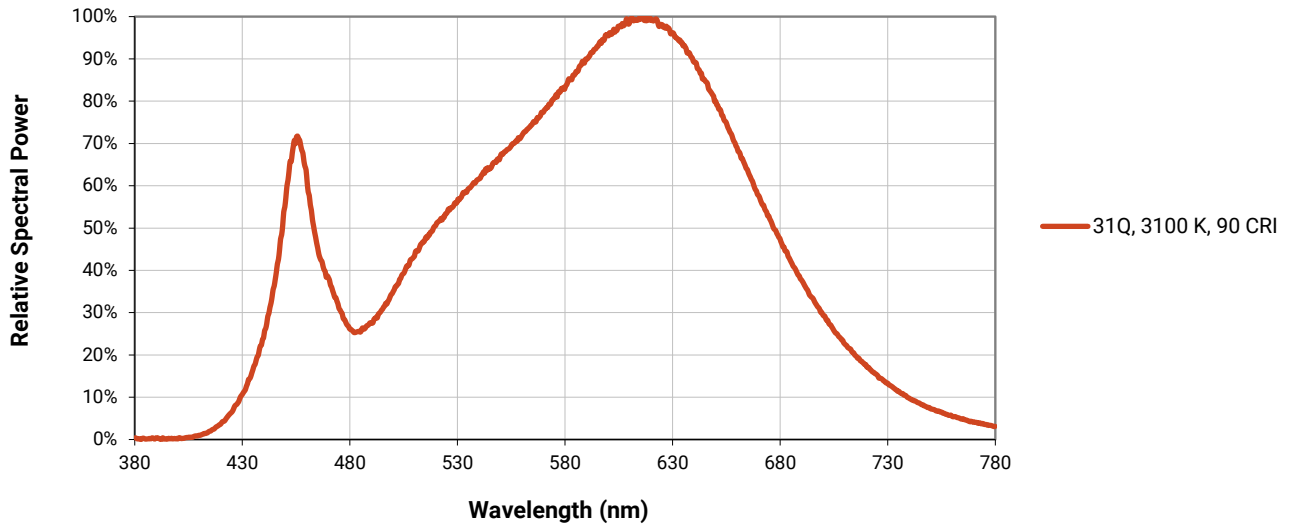

ELECTRICAL CHARACTERISTICS

The following graph is the result of a series of steady-state measurements.

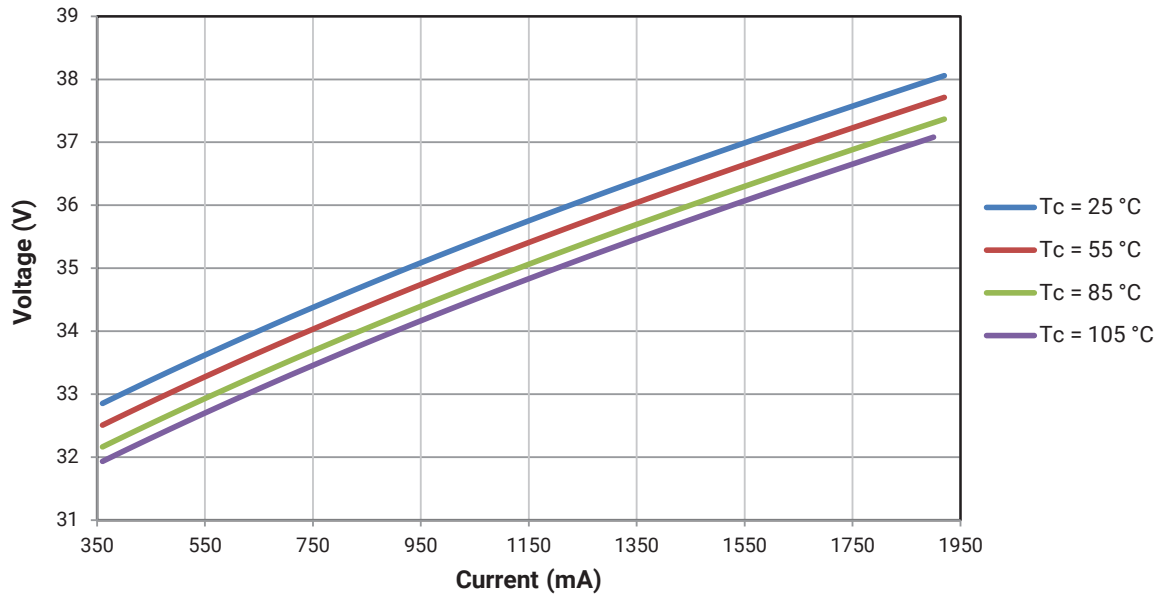

RELATIVE LUMINOUS FLUX

The relative luminous flux values provided below are the ratio of:

- Measurements of the CMU1526 LED at steady-state operation at the given conditions, divided by
- Flux measured during binning, which is a pulsed measurement at 720 mA at $T_j = 85\text{ °C}$.

For example, at steady-state operation of $T_c = 55\text{ °C}$, $I_f = 1550\text{ mA}$, the relative luminous flux ratio is 200% in the chart below. A CMU1526 LED that measures 4530 lm during binning will deliver 9060 lm (4530×2) at steady-state operation of $T_c = 55\text{ °C}$, $I_f = 1550\text{ mA}$.

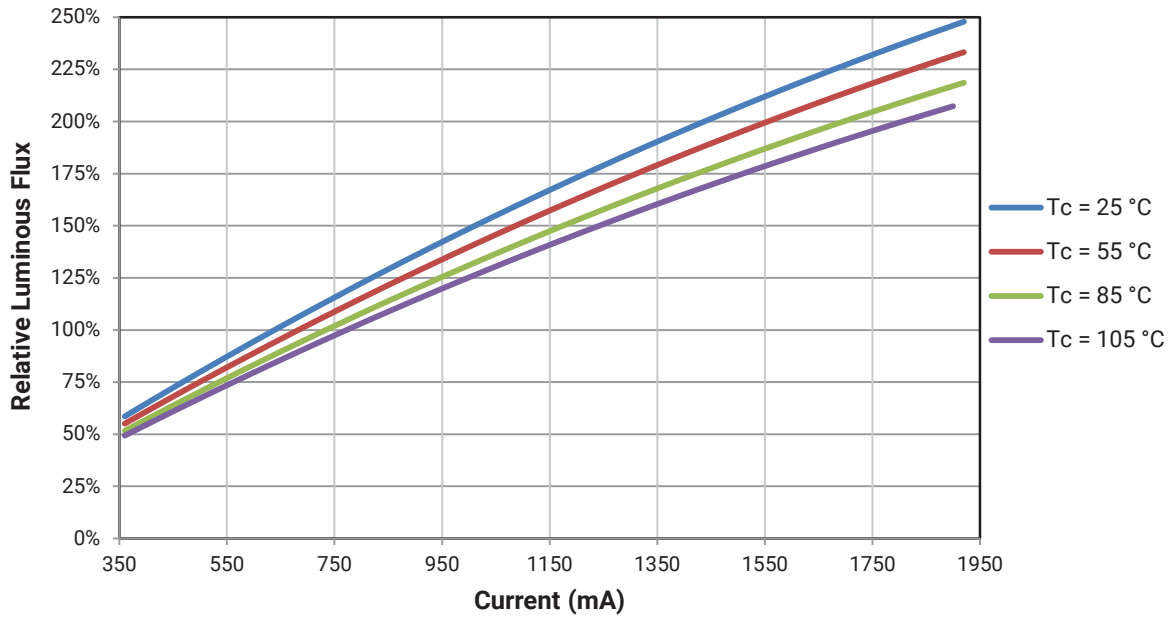

RELATIVE CHROMATICITY VS. CURRENT AND TEMPERATURE

The following graphs are the result of a series of steady-state measurements. Chromaticity is shown relative to the chromaticity measured at binning, which is a pulsed measurement at $T_j = 85^\circ\text{C}$.

4000 K, 80 CRI

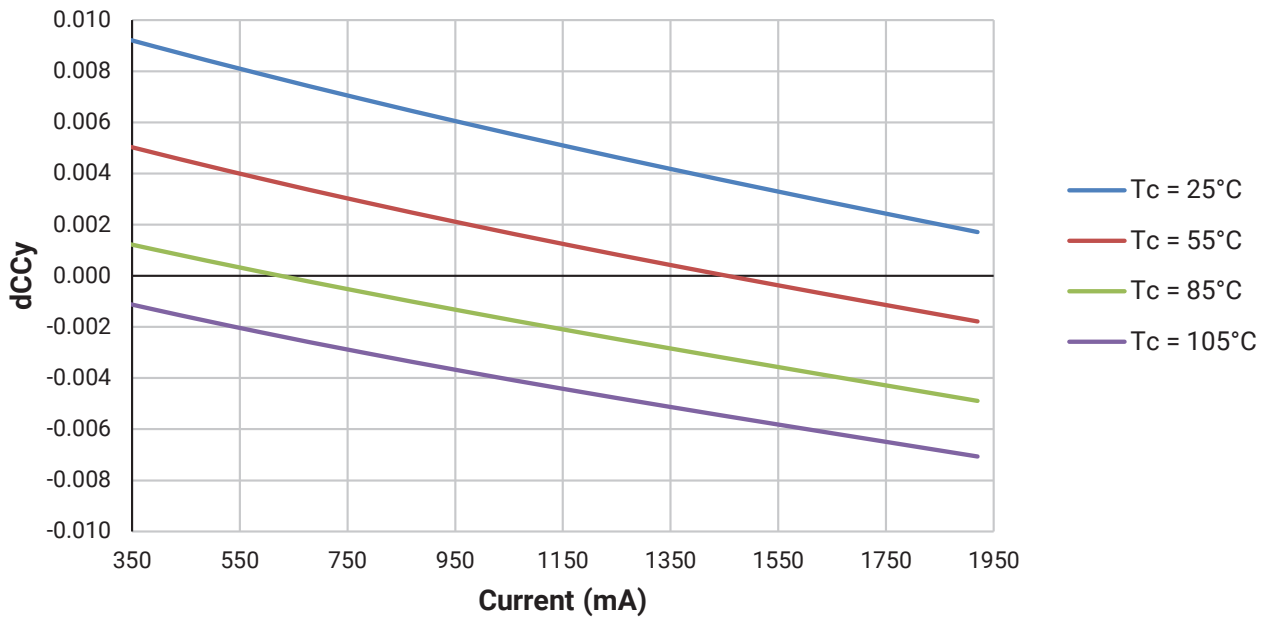
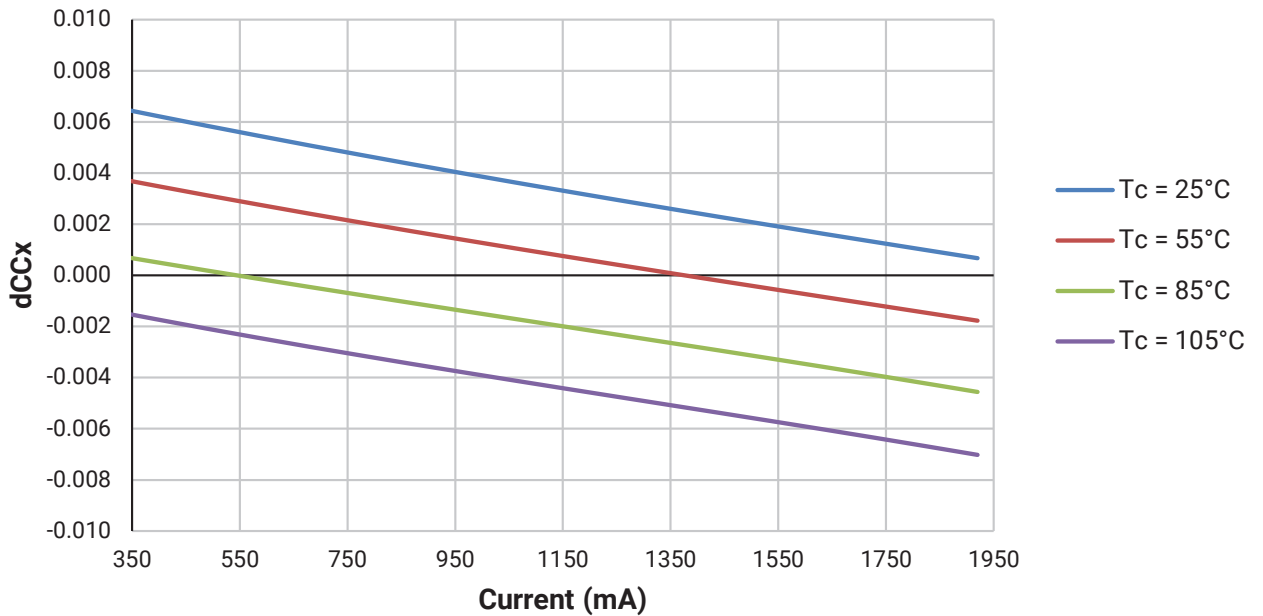

- Relative Chromaticity versus Current and Temperature are shown for reference only. These graphs are not a specification.

RELATIVE CHROMATICITY VS. CURRENT AND TEMPERATURE - CONTINUED

4000 K, 90 CRI

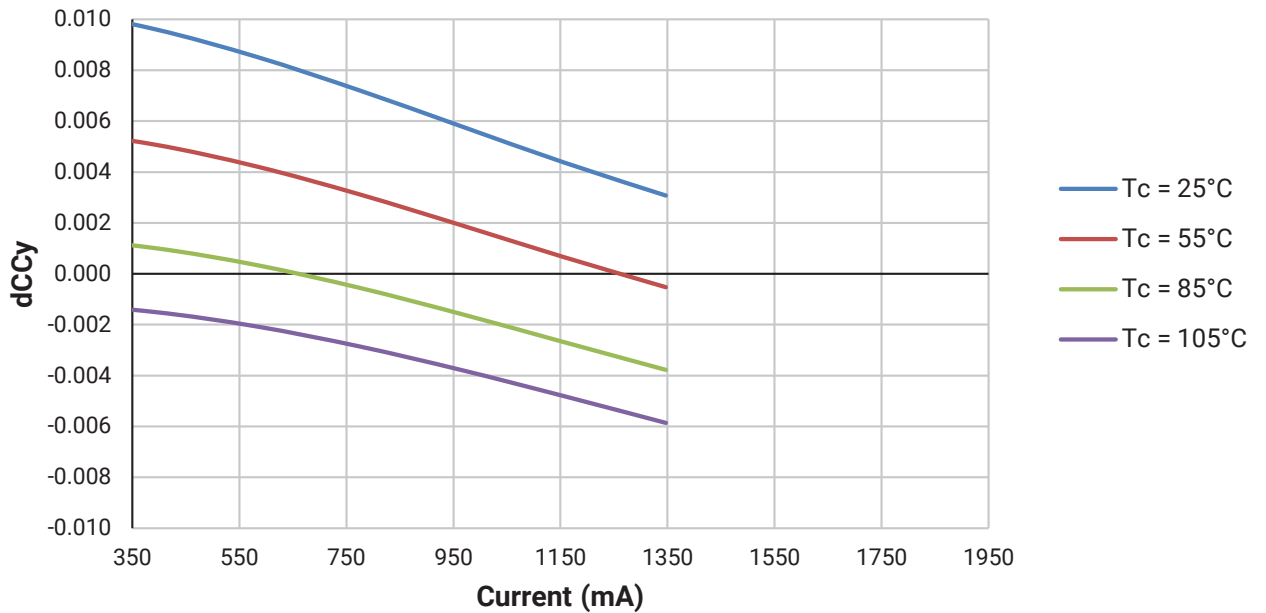
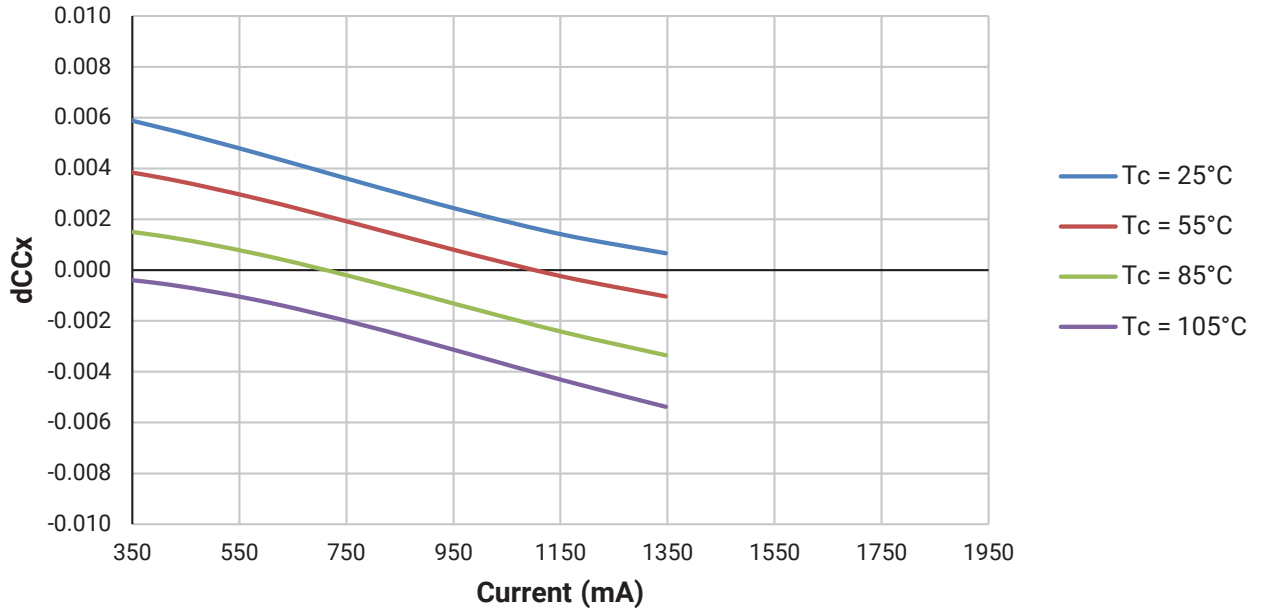

• Relative Chromaticity versus Current and Temperature are shown for reference only. These graphs are not a specification.

RELATIVE CHROMATICITY VS. CURRENT AND TEMPERATURE - CONTINUED

3000 K, 80 CRI

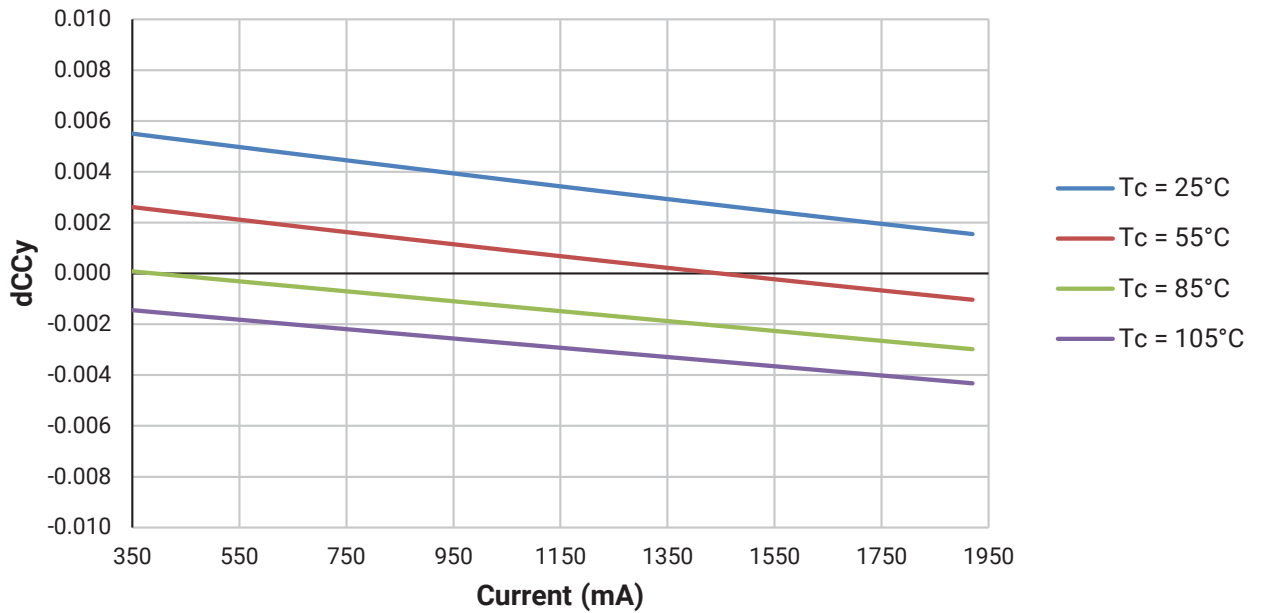
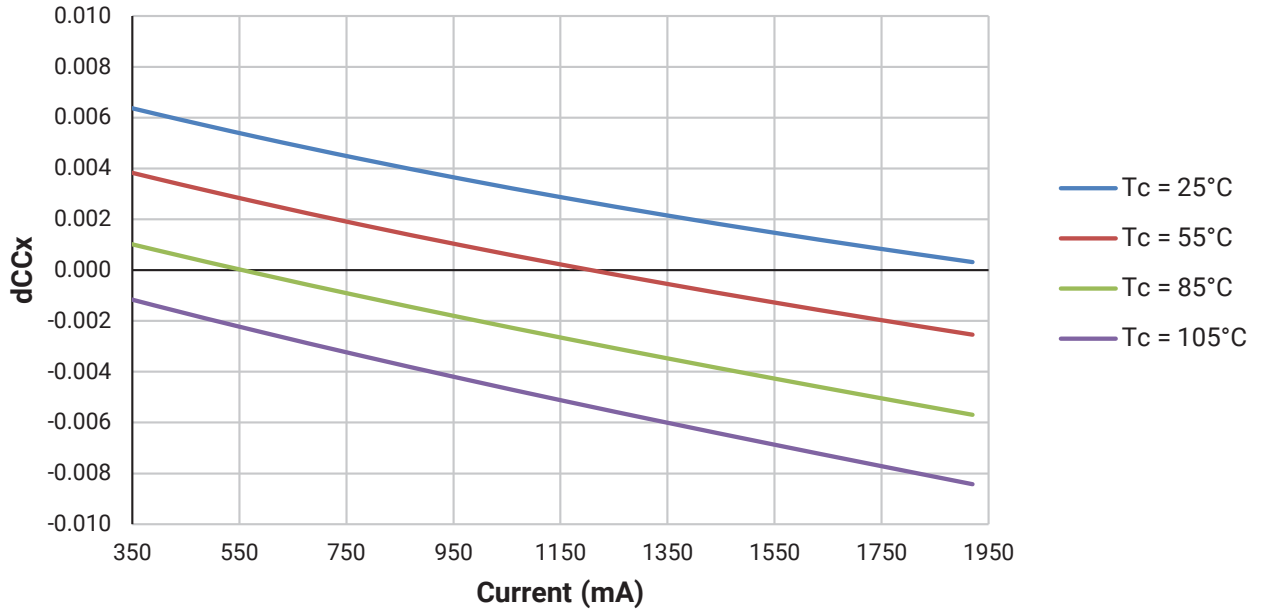

• Relative Chromaticity versus Current and Temperature are shown for reference only. These graphs are not a specification.

RELATIVE CHROMATICITY VS. CURRENT AND TEMPERATURE - CONTINUED

3000 K, 90 CRI

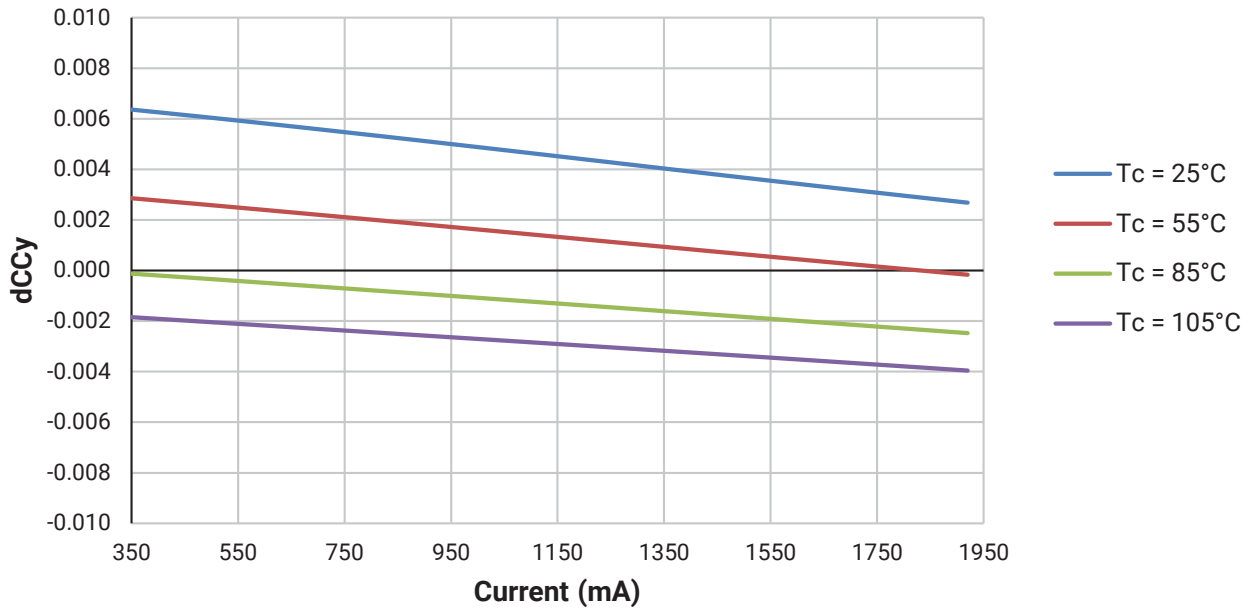
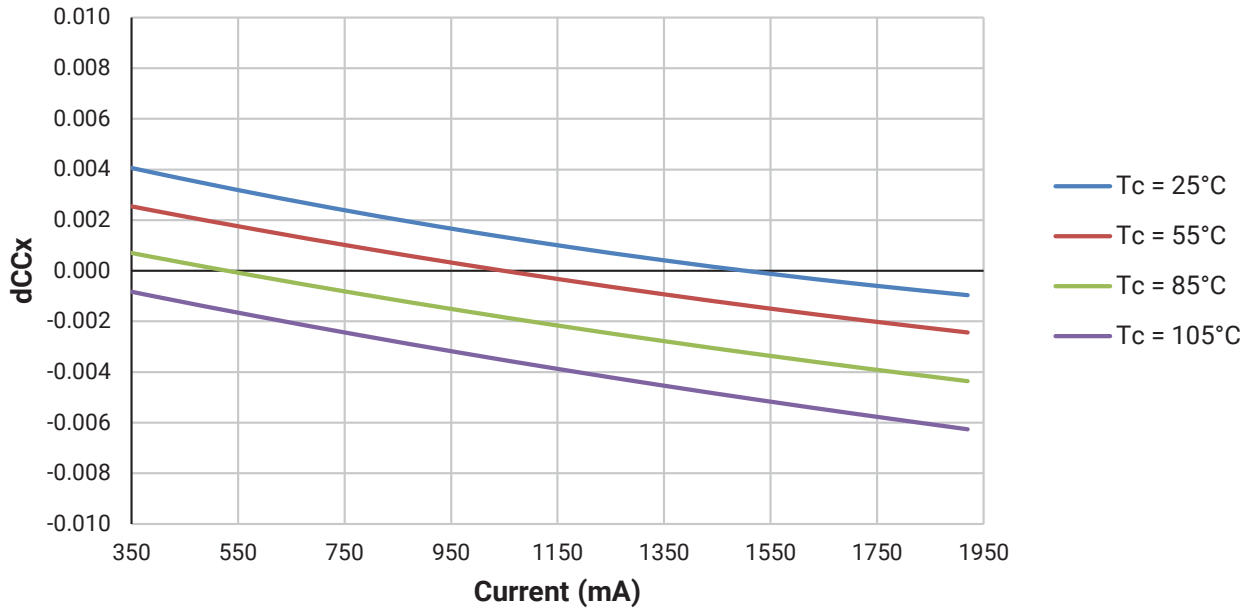

• Relative Chromaticity versus Current and Temperature are shown for reference only. These graphs are not a specification.

TYPICAL SPATIAL DISTRIBUTION

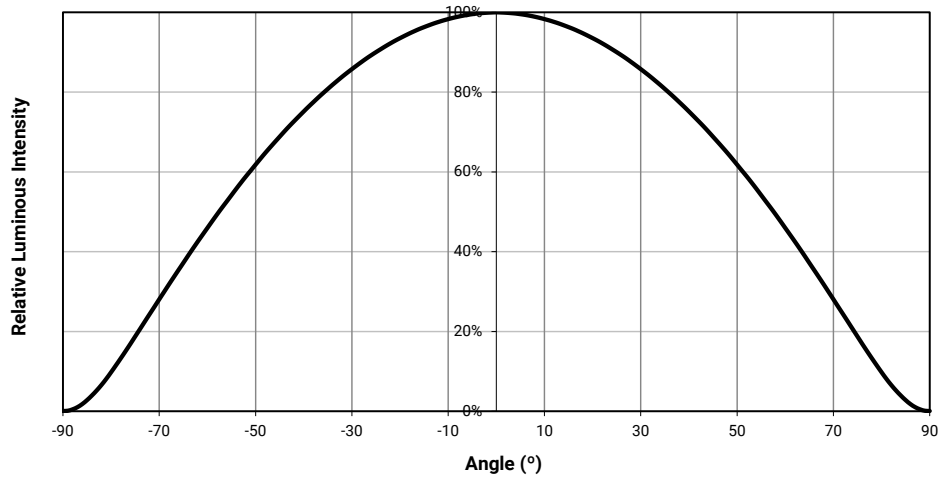

PERFORMANCE GROUPS - CHROMATICITY ($T_j = 85\text{ }^\circ\text{C}$)

XLamp CMU1526 LEDs are tested for chromaticity and placed into one of the regions defined by the following bounding coordinates.

EasyWhite Color Temperatures – 2-Step			
Code	CCT	x	y
40H	4000 K	0.3777	0.3739
		0.3797	0.3816
		0.3861	0.3855
		0.3838	0.3777
35H	3500 K	0.4022	0.3858
		0.4053	0.3942
		0.4125	0.3977
		0.4091	0.3891
30H	3000 K	0.4287	0.3975
		0.4328	0.4064
		0.4390	0.4086
		0.4347	0.3996
27H	2700 K	0.4524	0.4048
		0.4574	0.4140
		0.4633	0.4154
		0.4581	0.4062
22H	2200 K	0.5004	0.4112
		0.5068	0.4206
		0.5128	0.4204
		0.5063	0.4110

EasyWhite Color Temperatures – 3-Step Ellipse						
Bin Code	CCT	Center Point		Major Axis	Minor Axis	Rotation Angle (°)
		x	y	a	b	
65G	6500 K	0.3123	0.3282	0.00666	0.00330	61.0
57G	5700 K	0.3287	0.3417	0.00738	0.00360	72.0
50G	5000 K	0.3447	0.3553	0.00840	0.00312	65.0
40G	4000 K	0.3818	0.3797	0.00939	0.00402	53.7
35G	3500 K	0.4073	0.3917	0.00927	0.00414	54.0
31Q	3100 K	0.4236	0.3888	0.00848	0.00455	50.3
30G	3000 K	0.4338	0.4030	0.00834	0.00408	53.2
30Q	3000 K	0.4305	0.3935	0.00834	0.00408	53.2
30U	3000 K	0.4274	0.3837	0.00834	0.00408	53.2
27G	2700 K	0.4577	0.4099	0.00834	0.00420	48.5
22G	2200 K	0.5066	0.4158	0.00980	0.00480	45.5

PERFORMANCE GROUPS - CHROMATICITY ($T_j = 85\text{ }^\circ\text{C}$) - CONTINUED

EasyWhite Color Temperatures – 5-Step Ellipse						
Bin Code	CCT	Center Point		Major Axis	Minor Axis	Rotation Angle (°)
		x	y	a	b	
65E	6500 K	0.3123	0.3282	0.01110	0.00550	61.0
57E	5700 K	0.3287	0.3417	0.01230	0.00600	72.0
50E	5000 K	0.3447	0.3553	0.01400	0.00520	65.0
40E	4000 K	0.3818	0.3797	0.01565	0.00670	53.7
30E	3000 K	0.4338	0.4030	0.01390	0.00680	53.2

PREMIUM COLOR PERFORMANCE GROUPS - CHROMATICITY ($T_j = 85\text{ }^\circ\text{C}$)

XLamp CMU1526 LEDs are tested for chromaticity and placed into one of the regions defined by the following bounding coordinates.

Fidelity

EasyWhite Color Temperatures – 2-Step			
Code	CCT	x	y
40H	4000 K	0.3777	0.3739
		0.3797	0.3816
		0.3861	0.3855
		0.3838	0.3777
35H	3500 K	0.4022	0.3858
		0.4053	0.3942
		0.4125	0.3977
		0.4091	0.3891
30H	3000 K	0.4287	0.3975
		0.4328	0.4064
		0.4390	0.4086
		0.4347	0.3996
27H	2700 K	0.4524	0.4048
		0.4574	0.4140
		0.4633	0.4154
		0.4581	0.4062

PREMIUM COLOR PERFORMANCE GROUPS - CHROMATICITY ($T_j = 85\text{ }^\circ\text{C}$) - CONTINUED

Specialty

EasyWhite Color Temperatures – 2-Step			
Code	CCT	x	y
L7C	3000 K	0.4192	0.3754
		0.4224	0.3823
		0.4291	0.3847
		0.4257	0.3777

EasyWhite Color Temperatures – 3-Step Ellipse						
Bin Code	CCT	Center Point		Major Axis	Minor Axis	Rotation Angle (°)
		x	y	a	b	
31Q	3100 K	0.4236	0.3888	0.00848	0.00455	50.3
30Q	3000 K	0.4305	0.3935	0.00834	0.00408	53.2
30U	3000 K	0.4274	0.3837	0.00834	0.00408	53.2

EASYWHITE® BINS PLOTTED ON THE 1931 CIE COLOR SPACE ($T_j = 85\text{ }^\circ\text{C}$)

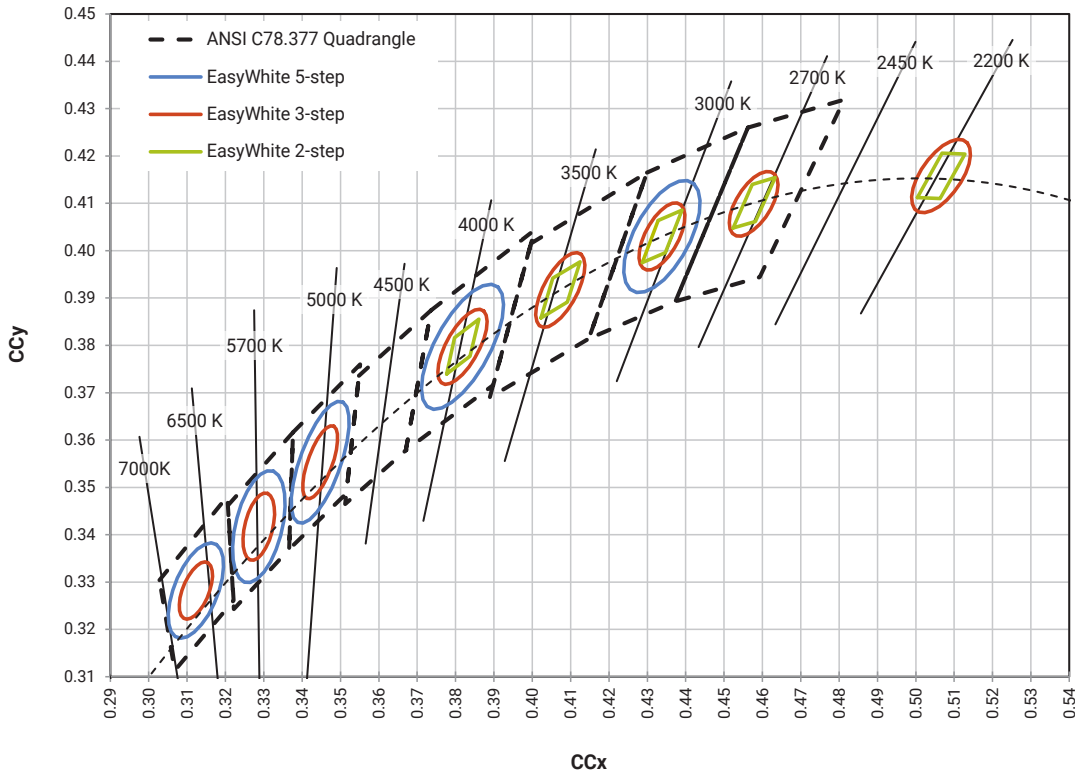

PREMIUM COLOR BINS PLOTTED ON THE 1931 CIE COLOR SPACE ($T_j = 85\text{ }^\circ\text{C}$)

Fidelity (2-step)

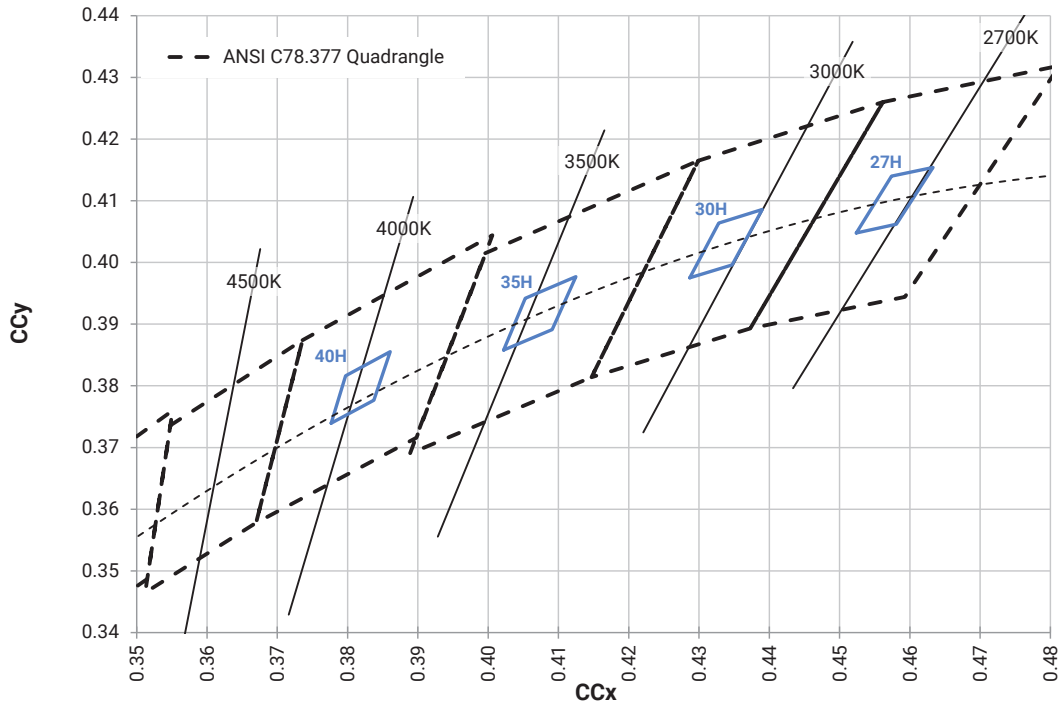

PREMIUM COLOR BINS PLOTTED ON THE 1931 CIE COLOR SPACE ($T_j = 85\text{ }^\circ\text{C}$) - CONTINUED

Specialty (2-step)

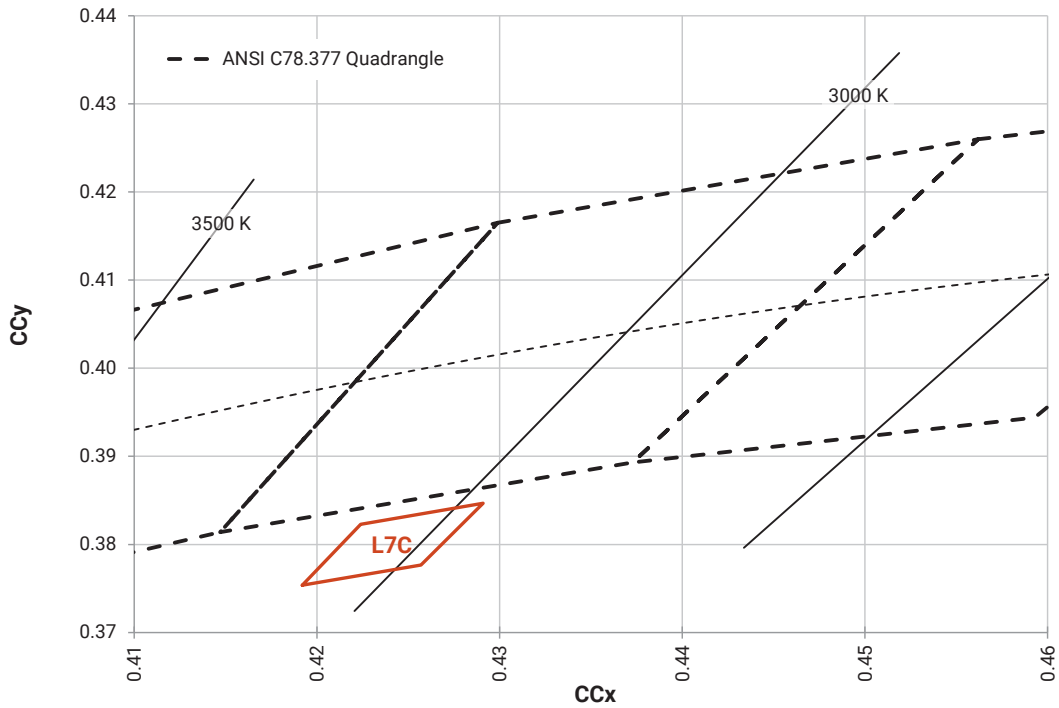

Specialty (3-step)

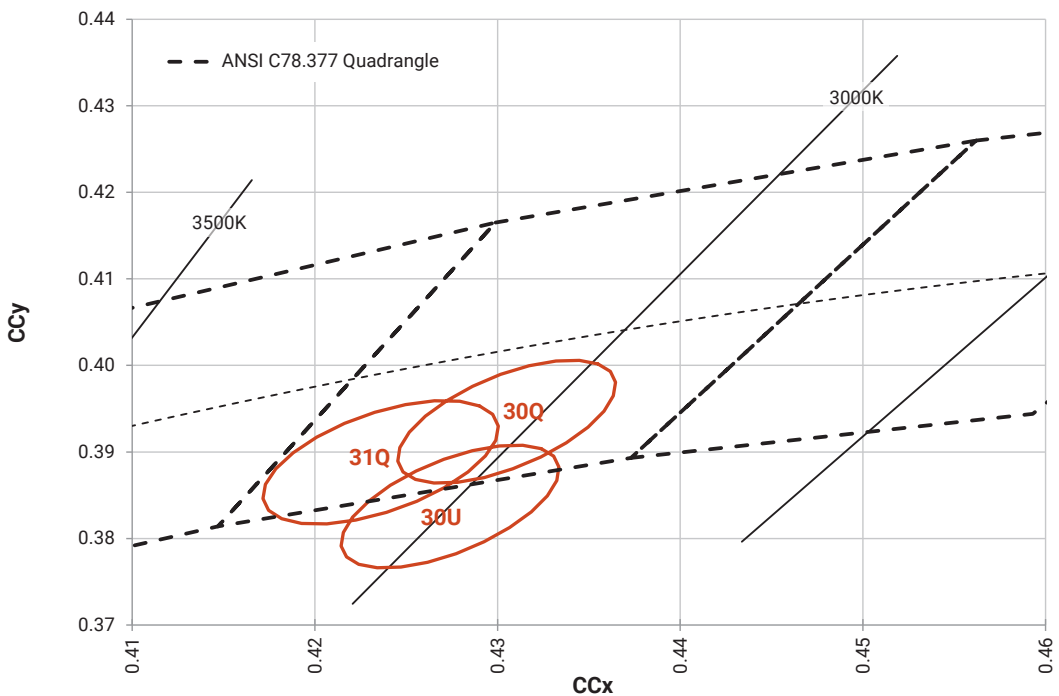

BIN AND ORDER CODE FORMATS

Bin codes and order codes are configured as follows:

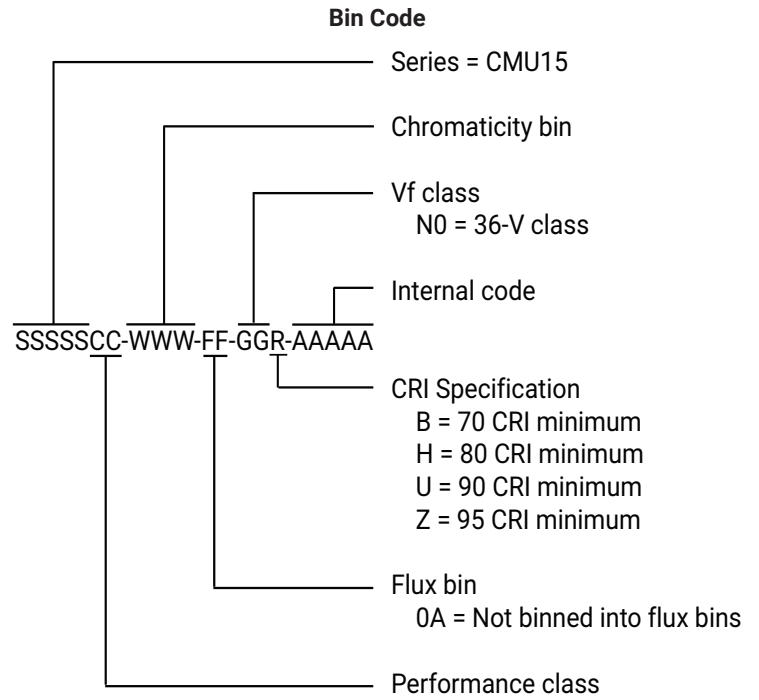
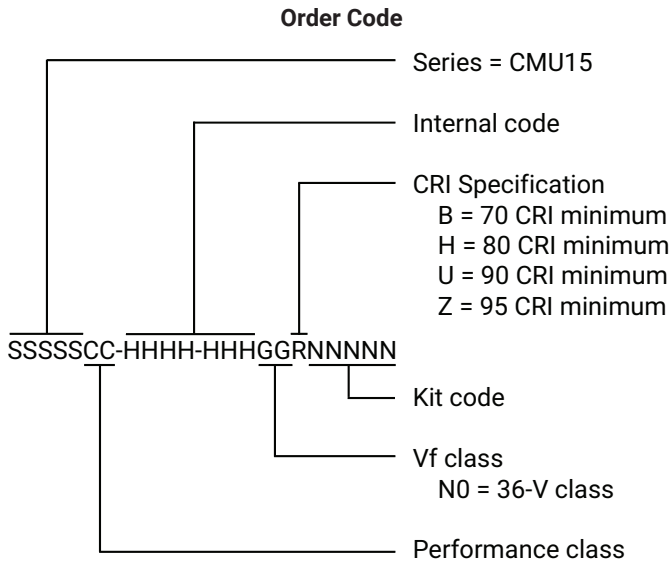

MECHANICAL DIMENSIONS

Dimensions are in mm.

Tolerances unless otherwise specified: $\pm .13$

$x^\circ \pm 1^\circ$

Meaning of LED marking

U1526N = 36-V CMU1526

$X_1 X_2 X_3 X_4 X_5$

X1 CCT

- 1 = 6500 K
- 2 = 5700 K
- 3 = 5000 K
- 5 = 4000 K
- 6 = 3500 K
- 7 = 3000 K
- 8 = 2700 K
- A = 2200 K

X2

- M = EasyWhite LED on the black-body line
- Q = Specialty LED below the black-body line
- U = Specialty LED below the black-body line

X3 Flux bin

X4

- 0A = Not binned into flux bins

X5 CRI

- B = 70 CRI min
- H = 80 CRI min
- U = 90 CRI min
- Z = 95 CRI min

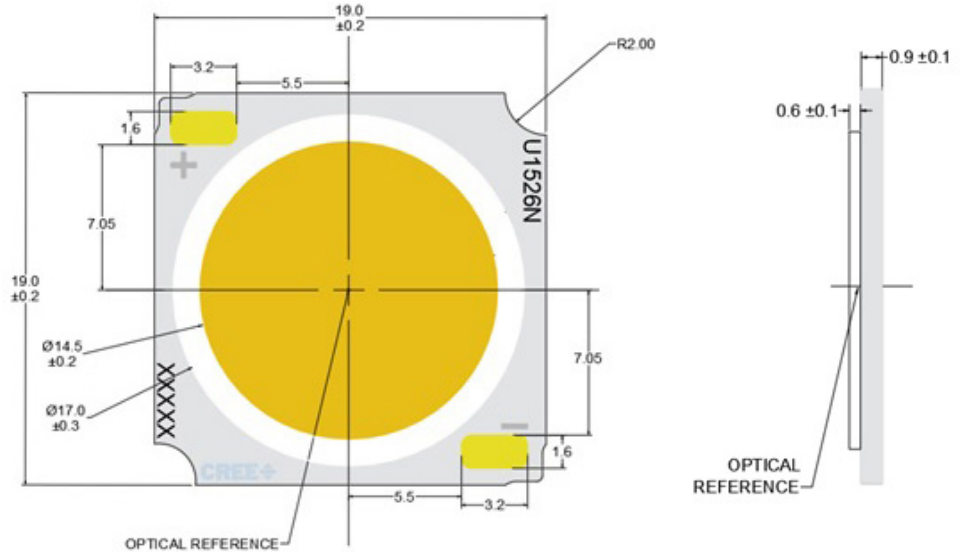

To assist in identifying the LED, CMU1526 LEDs provide a 2D barcode, positioned on the back of the LED, as shown in the following diagram. For a complete description of the bar code format, please refer to the [XLamp CM Family LEDs soldering and handling document](#).

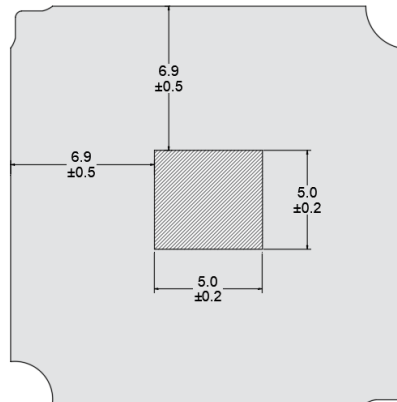

Tc measurement point: either the anode or cathode solder pad

THERMAL DESIGN

The CMU family of LED arrays can include over a hundred different LED die inside one package, and thus over a hundred different junction temperatures (T_j). Cree LED has intentionally removed junction-temperature-based operating limits and replaced the commonplace maximum T_j calculations with maximum ratings based on forward current (I_f) and case temperature (T_c). No additional calculations are required to ensure the CMU LED is being operated within its designed limits. LES temperature measurement provides additional verification of good thermal design. Please refer to page 3 for the Operating Limit specification.

There is no need to calculate for T_j inside the package, as the thermal management design process, specifically from solder point (T_{sp}) to ambient (T_a), remains identical to any other LED component. For more information on thermal management of XLamp LEDs, please refer to the [Thermal Management application note](#). For CMU soldering recommendations and more information on thermal interface materials (TIM), LES temperature measurement, and connection methods, please refer to the [XLamp CM Family LEDs soldering and handling document](#).

To keep the CMU1526 LED at or below the maximum rated T_c , the case to ambient temperature thermal resistance (R_{c-a}) must be at or below the maximum R_{c-a} value shown on the following graph, depending on the operating environment. The y-axis in the graph is a base 10 logarithmic scale.

As the figure at right shows, the R_{c-a} value is the sum of the thermal resistance of the TIM (R_{tim}) plus the thermal resistance of the heat sink (R_{hs}).

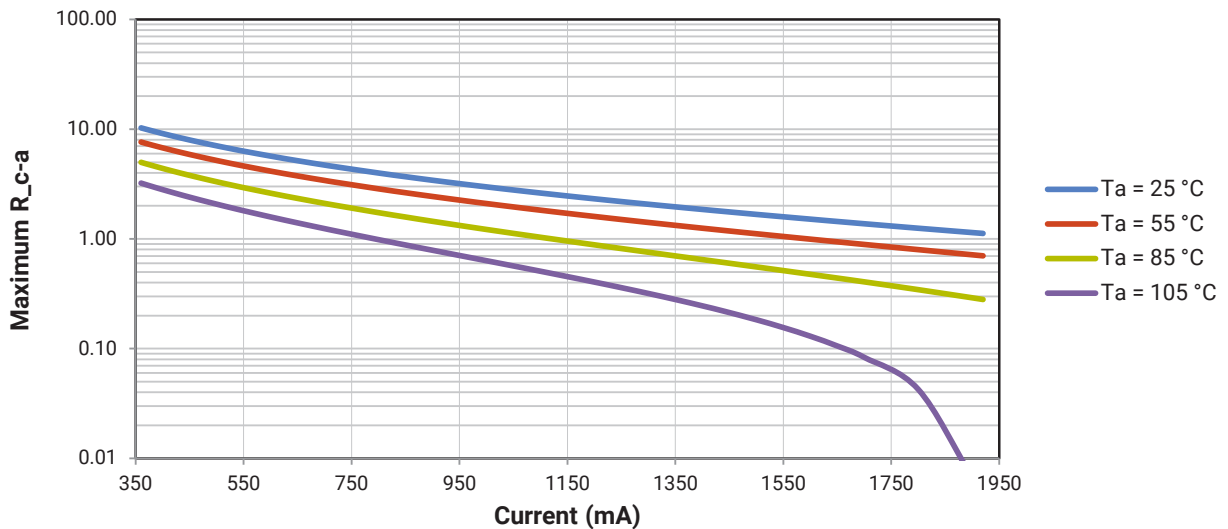
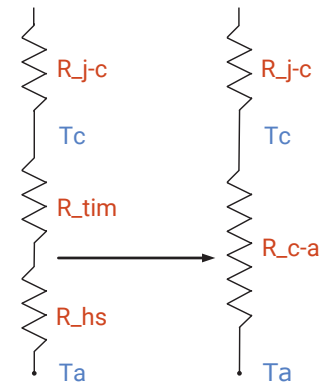

NOTES

Measurements

The luminous flux, radiant power, chromaticity, forward voltage and CRI measurements in this document are binning specifications only and solely represent product measurements as of the date of shipment. These measurements will change over time based on a number of factors that are not within Cree LED's control and are not intended or provided as operational specifications for the products. Calculated values are provided for informational purposes only and are not intended or provided as specifications.

Pre-Release Qualification Testing

Please read the [LED Reliability Overview](#) for details of the qualification process Cree LED applies to ensure long-term reliability for XLamp LEDs and details of Cree LED's pre-release qualification testing for XLamp LEDs. Cree LED did not perform Room Temperature Operating Life (RTOL) testing on the CMU1526 LED.

Lumen Maintenance

Cree LED now uses standardized IES LM-80-08 and TM-21-11 methods for collecting long-term data and extrapolating LED lumen maintenance. For information on the specific LM-80 data sets available for this LED, refer to the public [LM-80 results document](#).

Please read the [Long-Term Lumen Maintenance application note](#) for more details on Cree LED's lumen maintenance testing and forecasting. Please read the [Thermal Management application note](#) for details on how thermal design, ambient temperature, and drive current affect the LED junction temperature.

RoHS Compliance

The levels of RoHS restricted materials in this product are below the maximum concentration values (also referred to as the threshold limits) permitted for such substances, or are used in an exempted application, in accordance with EU Directive 2011/65/EC (RoHS2), as implemented January 2, 2013. RoHS Declarations for this product can be obtained from your Cree LED representative or from the [Product Ecology](#) section of the Cree LED website.

REACH Compliance

REACH substances of very high concern (SVHCs) information is available for this product. Since the European Chemical Agency (ECHA) has published notice of their intent to frequently revise the SVHC listing for the foreseeable future, please contact a Cree LED representative to insure you get the most up-to-date REACH SVHC Declaration. REACH banned substance information (REACH Article 67) is also available upon request.

UL® Recognized Component

This product meets the requirements to be considered a UL Recognized Component with Level 4 enclosure consideration. The LED package or a portion thereof has been investigated as a fire and electrical enclosure per ANSI/UL 8750.

Vision Advisory

WARNING: Do not look at an exposed lamp in operation. Eye injury can result. For more information about LEDs and eye safety, please refer to the [LED Eye Safety application note](#).

PACKAGING

CMU1526 LEDs are packaged in trays of 45. Five trays are sealed in an anti-static bag and placed inside an inner box, for a total of 225 LEDs per box. Each box contains LEDs from the same performance bin. Eight boxes are placed inside a carton, for a total of 1,800 LEDs per carton.

Dimensions are in mm.

Tolerances: ± 0.5 mm

Load Tray

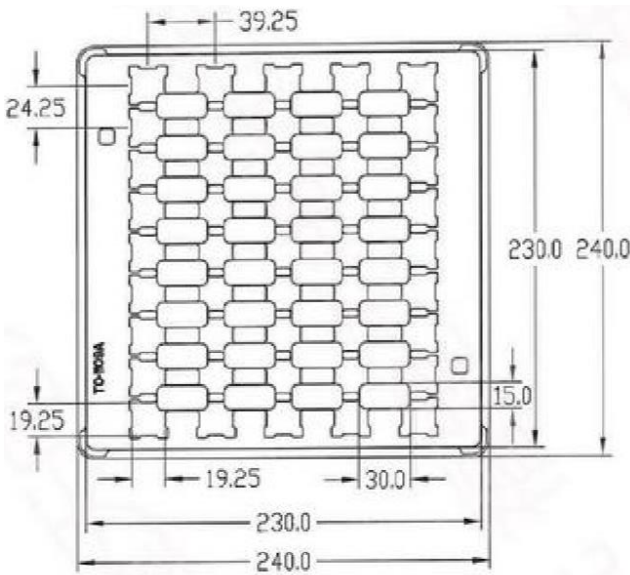

Upper Tray

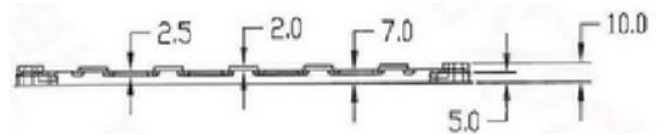
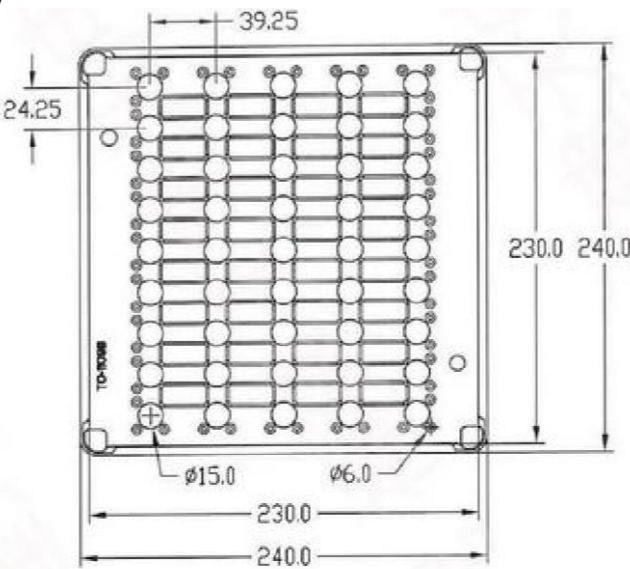

PACKAGING - CONTINUED

CMU1526 LEDs are packaged in trays of 45. Five trays are sealed in an anti-static bag and placed inside an inner box, for a total of 225 LEDs per box. Each box contains LEDs from the same performance bin. Eight boxes are placed inside a carton, for a total of 1,800 LEDs per carton.

Dimensions are in mm.
Tolerances: ± 3 mm

Inner Box

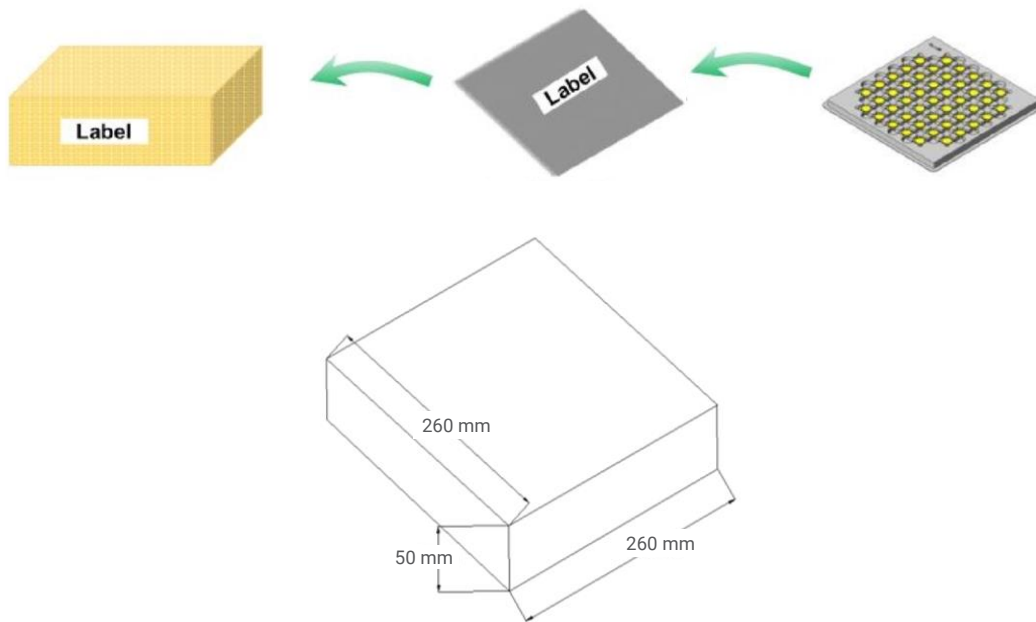

Outer Carton

