

# CombiTac unique Main catalog

**Modular connector solutions for up to 100,000 mating cycles**

EN



## STÄUBLI ELECTRICAL CONNECTORS

## Connections for Life



**Stäubli, as the international technology leader, offers innovative mechatronics solutions in its four divisions: Electrical Connectors, Fluid Connectors, Robotics, and Textile. At Stäubli Electrical Connectors, we develop advanced connection solutions based on the reliable MULTILAM contact technology.**

#### Together for reliable and safe connections

We know that you entrust us with the functionality of your applications and we work hard to ensure this every single day. Thanks to our high level of expertise, our extensive experience and the multiple successful co-operation with our partners, numerous new developments have originated at Stäubli Electrical Connectors and subsequently have become worldwide standards. This includes our MC4 connector portfolio for which we are today the global market

We create connections for life – and our customers are at the center of these connections. We are convinced that solid and stable partnerships directly contribute to our mutual success.

We take on the needs of our partners and deal with the most extraordinary challenges. As a result, we always create, sell and

support reliable and long-lasting products for markets with the highest productivity and safety requirements in close cooperation with our customers.

leader in photovoltaic. As the Stäubli original, the MC4 represents the result of our constant quest for innovation, quality and safety.

Further examples are the CombiTac modular connector system or the Quick Charging Connector (QCC) for automatic charging systems.

We ensure connections for life together with our long-standing customers in a wide range of industries from renewable energies, power transmission and distribution and E-mobility to industrial automation applica-

tions, railway and welding automation, test and measurement and medical devices.

Thus, developing reliable, efficient and safe solutions based on our proven MULTILAM contact technology, which guarantees a high service lifetime in addition to highly efficient power transmission.

# Applications and advantages



**CombiTac modular connectors combine various connection types in a single frame or housing and can be configured according to your exact specifications.**

Depending on the requirements of your application, two product lines are available, the CombiTac uniq and the CombiTac direqt.

CombiTac uniq is designed for more demanding applications that require versatile long-life modular connector solutions, and where combination of power, signal, data, fiber optic, fluid and pneumatic connections are needed.

CombiTac uniq is 100 % customizable to meet exact technical and dimensional specifications. The MULTILAM Technology enables up to 100,000 mating cycles and currents of up to 720 A.

As a solution provider, we offer you full support in the configuration of your own 100% customized CombiTac connector, including cable assembly if needed, depending on your requirements.

CombiTac direqt is ideal for applications that require fast, tool-free assembly and where electrical signal and power connections need to be combined with up to 10,000 mating cycles. This results in significant economic benefits. Contacts for data connections, coaxial connectors and pneumatic connections are also available.

This product catalog is dedicated to the CombiTac uniq product line. Information about CombiTac direqt can be found in the CombiTac direqt main catalog.

Further information concerning product portfolio, special features as well as exemplary videos can be found at [www.combitac.com](http://www.combitac.com)

# Content

<b>Page 6</b>	<b>The world of CombiTac</b> <ul style="list-style-type: none"> <li>• Plug into more possibilities</li> <li>• CombiTac Configurator</li> </ul>	<b>Page 54</b>	<b>Optical fiber unit GOF</b> <ul style="list-style-type: none"> <li>• (Glass optical fiber)</li> </ul>
<b>Page 8</b>	<b>CombiTac uniq</b> <ul style="list-style-type: none"> <li>• The modular connector system</li> </ul>	<b>Page 56</b>	<b>Thermocouple unit</b>
<b>Page 10</b>	<b>Fork connector</b> <ul style="list-style-type: none"> <li>• Up to 720 A</li> </ul>	<b>Page 60</b>	<b>Pneumatic unit</b>
<b>Page 12</b>	<b>Ø 12 mm Power unit</b> <ul style="list-style-type: none"> <li>• Up to 531 A</li> </ul>	<b>Page 70</b>	<b>Fluid unit</b>
<b>Page 16</b>	<b>Ø 8 mm Power unit</b> <ul style="list-style-type: none"> <li>• Up to 142 A</li> </ul>	<b>Page 78</b>	<b>Spacers</b>
<b>Page 18</b>	<b>Ø 6 mm and Ø 8 mm protective earth (PE) unit</b>	<b>Page 80</b>	<b>CombiTac align</b>
<b>Page 22</b>	<b>Ø 6 mm Power unit</b> <ul style="list-style-type: none"> <li>• Up to 117 A</li> </ul>	<b>Page 82</b>	<b>Single parts for CombiTac frames</b>
<b>Page 24</b>	<b>Ø 4 mm High voltage unit</b> <ul style="list-style-type: none"> <li>• Up to 5 kV</li> </ul>	<b>Page 83</b>	<b>Calculation of installation dimensions</b>
<b>Page 26</b>	<b>Ø 3 mm Power unit</b> <ul style="list-style-type: none"> <li>• Up to 39 A</li> </ul>	<b>Page 86</b>	<b>Panel mounted</b>
<b>Page 30</b>	<b>Ø 1.5 mm High voltage unit</b> <ul style="list-style-type: none"> <li>• Up to 2.5 kV</li> </ul>	<b>Page 88</b>	<b>DIN Aluminum housing IP65/67</b>
<b>Page 32</b>	<b>Ø 1.5 mm Signal unit</b> <ul style="list-style-type: none"> <li>• Up to 19 A</li> </ul>	<b>Page 104</b>	<b>DIN Aluminum housings IP65/67 with space saving locking</b>
<b>Page 34</b>	<b>Ø 1 mm Signal unit</b> <ul style="list-style-type: none"> <li>• Up to 6 A</li> </ul>	<b>Page 108</b>	<b>DIN Aluminum housing IP68/69K</b>
<b>Page 38</b>	<b>Ø 0.6 mm Signal unit</b> <ul style="list-style-type: none"> <li>• Up to 2 A</li> </ul>	<b>Page 110</b>	<b>Central locking IP65</b>
<b>Page 40</b>	<b>Last Mate First Break module</b>	<b>Page 111</b>	<b>DIN Plastic housing IP65</b>
<b>Page 42</b>	<b>Coaxial unit 6 GHz</b>	<b>Page 118</b>	<b>Protective grounding of conductive housings</b>
<b>Page 44</b>	<b>Coaxial unit 1.5 GHz</b>	<b>Page 120</b>	<b>PE module</b>
<b>Page 46</b>	<b>1 Gbit, 10 Gbit Data transfer unit</b>	<b>Page 123</b>	<b>Coding</b>
<b>Page 52</b>	<b>Optical fiber unit POF</b> <ul style="list-style-type: none"> <li>• (Plastic optical fiber)</li> </ul>	<b>Page 124</b>	<b>Crimping pliers</b>
		<b>Page 126</b>	<b>Assembly tools</b>
		<b>Page 129</b>	<b>Appendix</b> <ul style="list-style-type: none"> <li>• Derating diagrams</li> <li>• Technical information</li> <li>• Safety notes</li> <li>• Applications</li> <li>• Index</li> </ul>

# General information

## Changes/provisos

All data, illustrations and drawings in the catalog have been carefully checked. They correspond to our previous experience, but no liability can be accepted for errors.

We also reserve the right to make changes for construction and safety reasons. It is therefore advisable not to rely solely on the information in the catalog when designing devices in which our components are installed, but to consult us to ensure that this information is up to date. We would be happy to advise you.

## Copyright

The use of this catalog for any other purpose, in whatever form, without our prior written consent is not permitted.

## RoHS

European Directive 2011/65/EU incl. all related amendments (e.g. Delegated Directive (EU) 2015/863)

For further information please follow the link below

[www.staubli.com/de/en/electrical-connectors/downloads/certificates/material-compliance.html](http://www.staubli.com/de/en/electrical-connectors/downloads/certificates/material-compliance.html)



All products with the symbol are «UL recognized components».

## Symbols



**Accessories or special tools exist for this product**



**The assembly instructions MA000 are available for this product**



**Surface Ag**



**Surface Au**

## Abbreviations

CT	= CombiTac uniq
S	= Screw termination/ Socket
P	= Pin
PCB	= Flow soldered termination
C	= Crimp termination
L	= Soldering
AWG	= American Wire Gauge

## DIN housings

S	= Side cable entry
G, T	= Top cable entry
CH, TG	= Coupler hood
CHG, KG	= Coupler housing
PW	= Protective wall
PC	= Protective cover/cap
SM, AG	= Surface mount
PM, SG	= Pedestal mount
PS	= Park station
SD-...L/FSCH	= Plastic protective cover with lanyard for metal housing IP65
SSL	= Space saving locking
ZV	= Central locking

THE WORLD OF COMBITAC

# Plug into more possibilities

Experience combined with quality and modularity leads to cost-efficient, and durable connection solutions. The modular connector system CombiTac can be easily configured online and adapted to meet the most

demanding requirements. Reliability when you need it. Flexibility, if you want it: The world of CombiTac's modular connector system meets your needs.

## CombiTac direct



Click & connect  
Most assembly-effective  
10,000 mating cycles

The latest generation of modular connectors for power, signal, and pneumatic connections up to 10,000 mating cycles. The new user-friendly, tool-free click-and-connect system allows you to assemble your modular connector system in the most time-saving way.

## CombiTac uniq



100 % customizable  
Highest performance  
100,000 mating cycles

Modular connectors for power, signal, data, pneumatic and fluid connections up to 100,000 mating cycles. Offers the highest possible performance and can be customized to meet exact technical and dimensional specifications.

# CombiTac Configurator

The CombiTac configurator is a web application that enables you to put together your personalized CombiTac configuration

step by step on various end devices. It also allows you to receive a quotation for your selected CombiTac modular connector.



CombiTac Configurator

<https://configurator.combitac.com>

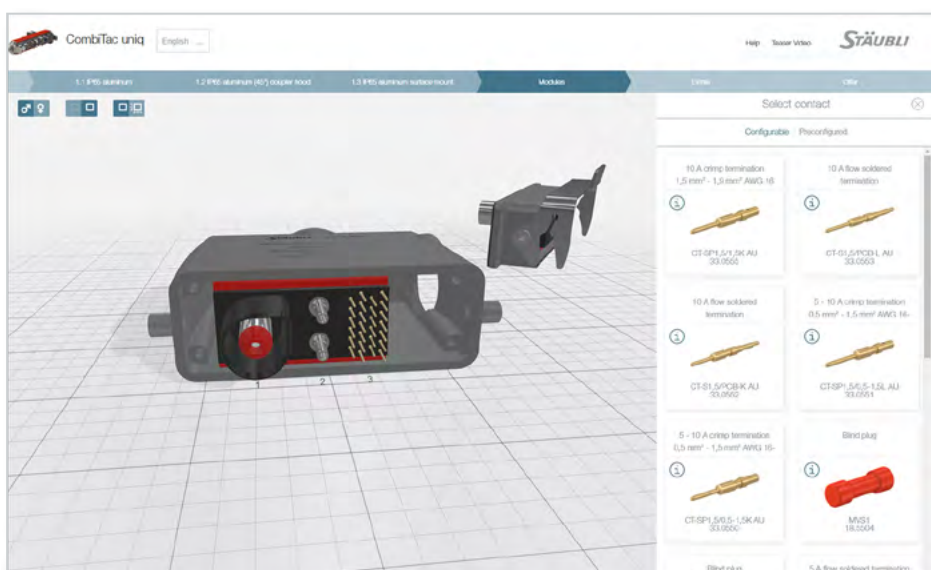

## COMBITAC UNIQ

# The modular connector system

### Coupler hoods

6 different sizes

### Rails

Included in delivery

May be ordered separately

### End pieces in 2 versions

- Housing assembly
- Panel mounting

Included in delivery

May be ordered separately

### Delivery status of the CombiTac

- Contact carriers mounted on rails
- Assembled with end pieces
- Contacts separately
- Pneumatic and fluid couplings will be mounted in the carriers
- PCB contacts will be mounted on request

### Possible connections

- Electric
- Thermocouple pressure contacts
- Coaxial
- Optical fiber
- Pneumatic
- Fluid
- Electric + PE
- Data transfer

### Fully assembled CombiTac connector with connecting lines

On request

### Surface and pedestal mount housing

6 different sizes

### Mating cycles

Panel mounted: up to 100,000

Housing assembly: up to 10,000

For the connector, the lowest mating cycle value of the individual components applies.





**FORK CONNECTOR UP TO 720 A**

# Contact carriers CT-E-GSR5-1-...

1-pole plastic contact carriers. The contacts are locked by means of a retaining clip CT-RC12.

**Note:**  
Not suitable for housing assembly.

**CT-E-GSR5-1-B UL**

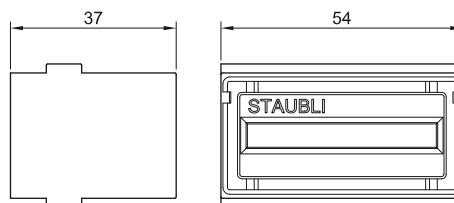

**CT-E-GSR5-1-S UL**

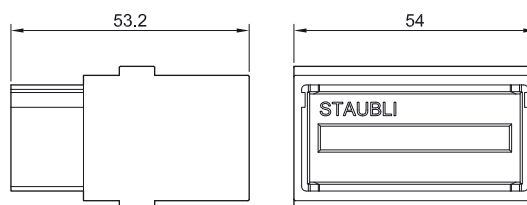

**CT-RC12**

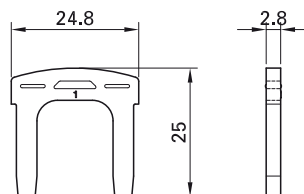

**Assembly instructions MA213-12**  
[www.staubli.com/electrical](http://www.staubli.com/electrical)

Order No.	Type	Description
33.4242	CT-E-GSR5-1-B UL	Socket carrier
33.4241	CT-E-GSR5-1-S UL	Plug carrier
33.4083	CT-RC12	Retaining clip (must be ordered separately)
33.4770	CT-DIP2/2	Protective element necessary on each side of a contact

Technical data		
Number of poles	1	
Pollution degree/overvoltage category	2/CAT II	3/CAT III
Rated voltage	1000 V	600 V
Rated voltage UL	600 V	
Degree of protection (socket front)	IP2X	
Clearances and creepage distance	IEC 60664-1:2020 and UL 1977	
Limiting temperature (IEC 61984:2008), upper	+125 °C	
lower	-40 °C	
Contact carrier material	PA	

# Contacts with screw termination

For contact carriers CT-E-GSR5-1-... Sockets fitted with MULTILAM.

**Type of termination:**

Screw connection for commercially available cable lug with corresponding specifications.

**CT-B-GSR5/600A AG**

**CT-S-GSR5/600A AG**

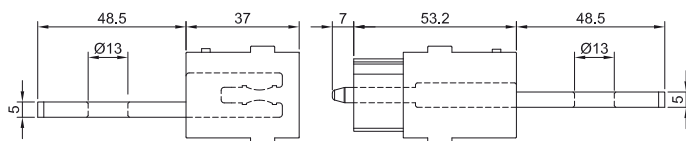

Order No.	Type	Socket	Plug	Surface	Conductor cross section			Rated current <sup>1)</sup> A	Type of termination
					mm <sup>2</sup>	AWG	MCM		
33.0770	CT-B-GSR5/600A AG	×			240		430	720	S
33.0670	CT-S-GSR5/600A AG		×						

Technical data	
Width/Height	42 mm/5 mm
Average sliding force	30 N
Connector resistance	< 30 µΩ
Mating cycles	100 000
Vibrations and shock	IEC 61373:2010 category 1B

<sup>1)</sup> IEC Rated values refer to copper wires in accordance with IEC 60364-5-52:2009.



Assembly instructions MA213-12

[www.staubli.com/electrical](http://www.staubli.com/electrical)

Ø 12 MM POWER UNIT UP TO 531 A

# Contact carriers CT-E12-1/...

1-pole plastic contact carriers. Different designs for pins and sockets.

The contacts are locked by means of a retaining clip CT-RC12.

**Note:**

Not suitable for housing assembly when using CT-BP12/120 AG (33.0147) and CT-SP12/120 IP2X AG (33.0597).

CT-E12-1/B

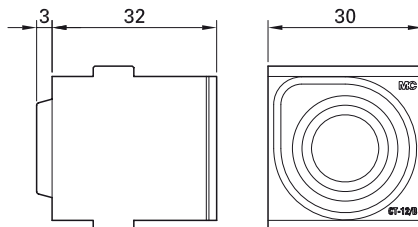

CT-E12-1/S

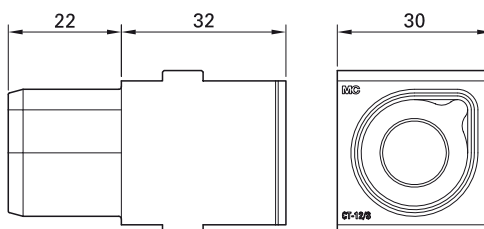

CT-RC12

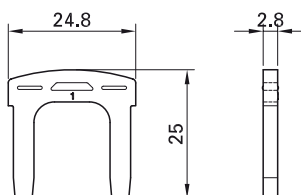

Assembly instructions MA213-01

[www.staubli.com/electrical](http://www.staubli.com/electrical)

Order No.	Type	Description
33.4082	CT-E12-1/B	Socket carrier (identification "B")
33.4081	CT-E12-1/S	Pin carrier (identification "S")
33.4083	CT-RC12	Retaining clip (one retaining clip is required per carrier)
33.4085	CT-DIP4/2	Protective element required on each side of all M10 contacts, see page 78

Technical data		
Number of poles	1	
For contact diameter	12 mm	
Pollution degree/overvoltage category	2/CAT II	3/CAT III
Rated voltage, crimp termination	1000 V	800 V
Rated voltage, screw termination		400 V
Rated voltage UL	1000 V	
Degree of protection (socket and plug front)	IP2X	
Clearances and creepage distance	IEC 60664-1:2020 and UL 1977	
Limiting temperature (IEC 61984:2008), upper	+125 °C	
Limiting temperature (IEC 61984:2008), lower	-40 °C	
Contact carrier material	PA	

# Ø 12 mm contacts with crimp termination

For contact carriers CT-E12-1/... Sockets fitted with MULTILAM.

**Type of termination:**  
Crimp termination (C) for Cu conductors (class 5 and 6)

CT-BP12/...



CT-SP12/...

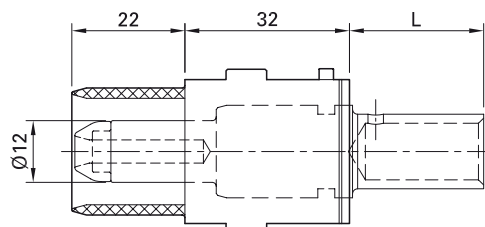

Order No.	Type	Socket	Pin	Surface	Conductor cross section			Rated current <sup>1)</sup>			Type of termination
					mm <sup>2</sup>	AWG	MCM	90 °C <sup>2)</sup>	125 °C <sup>2)</sup>	HTC Cable 125 °C <sup>3)</sup>	
33.0127 33.0558	CT-BP12/50 AG CT-SP12/50 IP2X AG	x	x		50	1/0		210	271		C
33.0128 33.0559	CT-BP12/70 AG CT-SP12/70 IP2X AG	x	x		70	2/0		260	336		C
33.0138 33.0562	CT-BP12/95 AG CT-SP12/95 IP2X AG	x	x		95	4/0		310	401		C
33.0147 33.0597	CT-BP12/120 AG CT-SP12/120 IP2X AG	x	x		120		262	359	464	531	C

## Technical data

Nominal-Ø socket/pin	12 mm
Average sliding force	28 N
Connector resistance	< 25 µΩ
Mating cycles	100,000

<sup>1)</sup> IEC Rated values refer to copper wires in accordance with IEC 60364-5-52:2009.

<sup>2)</sup> Ampacities up to 90 °C or 125 °C maximum metal surface temperature.

<sup>3)</sup> HTC: high thermal conductivity cable. At the given maximum rated current of 531 A the copper surface temperature of the cable must not be higher than 125 °C.



Assembly instructions MA213-01

[www.staubli.com/electrical](http://www.staubli.com/electrical)

# Ø 12 mm contacts with M10 inside thread

For contact carriers CT-E12-1/... Sockets fitted with MULTILAM

### Type of termination:

Screw termination (S) using an M10 inside thread by means of a cable lug for Cu conductors (class 5 and 6)

### Note:

Screw terminations can not be fitted in housings due to space limitations.

CT-B12/M10 AG



CT-S12/M10 IP2X AG

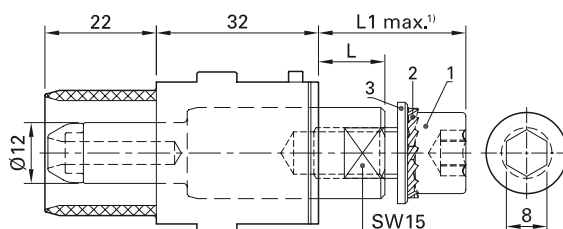

Order No.	Type	Socket	Pin	Surface	Conductor cross section		Rated current <sup>2)</sup>	Type of termination
					mm <sup>2</sup>	AWG		
33.0139	CT-B12/M10 AG	x			50	1/0	210	S
					70	2/0	260	
					95	4/0	310	
33.0564	CT-S12/M10 IP2X AG		x		50	1/0	210	S
					70	2/0	260	
					95	4/0	310	
33001501	K-SCH50-10 <sup>3)</sup>	Cable lug			50	1/0		
33.4114	K-SCH70-10 <sup>3)</sup>	Cable lug			70	2/0		
33.4115	K-SCH95-10 <sup>3)</sup>	Cable lug			95	4/0		

### Individual parts (supplied with 33.0139 and 33.0564)

Pos.	Order No.	Type	Remarks
1	11004669	ZYL-SHR-IN-6KT M10x20 ISO4762 BN610	Cheese head screw M10x20
2	08.0706	F/M10 DIN6798A BN781	Serrated lock washer F/M10
3	08.0306	U/M10 AG	Washer M10

Technical data	
Nominal-Ø socket/pin	12 mm
Average sliding force	28 N
Connector resistance	< 25 µΩ
Mating cycles	100,000

<sup>1)</sup> Depending on cable lug size.

<sup>2)</sup> IEC Rated values refer to copper wires in accordance with IEC 60364-5-52:2009.

<sup>3)</sup> Cable lugs Cu/Sn according to DIN 46234.

# Selection of special DIN housings for CombiTac Ø 12 mm power unit

**Step 1:** Select the number of Ø 12 mm contacts of your CombiTac connector (e.g. 2 x Ø 12 mm contacts)

**Step 2:** Select the outer insulation diameter of your cable (e.g. 17 mm)

**Step 3:** Select the appropriate cable gland (e.g. order No. 33.4126 or 33.4122)

**Step 4:** Select a suitable DIN housing (e.g. size 3, order No. 33.2713)

1 Number of contacts	2 For Ø cable mm	3 Cable gland				4 Suitable housing			
		Size M	Order No.	Type	Wrench size max. mm	Size	Order No.	Type	Position of cable glands
2	9.5 – 12.5	25	<b>33.4120</b>	CT-K-VSH M25x9,5-12,5 MS	30	3	<b>33.2713</b>	CT-CH3-T/2xM25	
	10 – 17		<b>33.4126</b>	CT-K-VSH M25x10-17 MS	28				
	16 – 20.5		<b>33.4122</b>	CT-K-VSH M25x16-20,5 MS	30				
	17 – 21	32	<b>33.4124</b>	CT-K-VSH M32x17-21 MS	36	4	<b>33.2814</b>	CT-CH4-T/2xM32	
	21 – 25		<b>33.4125</b>	CT-K-VSH M32x21-25,5 MS	36				
3	10 – 17	25	<b>33.4126</b>	CT-K-VSH M25x10-17 MS	28	4	<b>33.2744</b>	CT-CH4-T/3xM25	
	9.5 – 12.5	25	<b>33.4120</b>	CT-K-VSH M25x9,5-12,5 MS	30	5 <sup>1)</sup>	<b>33.3175</b>	CT-CH5-T/4xM25	
	10 – 17		<b>33.4126</b>	CT-K-VSH M25x10-17 MS	28				
	16 – 20.5		<b>33.4122</b>	CT-K-VSH M25x16-20,5 MS	30				
	17 – 21	32	<b>33.4124</b>	CT-K-VSH M32x17-21 MS	36	6 <sup>1)</sup>	<b>33.3196</b>	CT-CH6-T/3xM32	
21 – 25	<b>33.4125</b>		CT-K-VSH M32x21-25,5 MS	36					
4	9.5 – 12.5	25	<b>33.4120</b>	CT-K-VSH M25x9,5-12,5 MS	30	5 <sup>1)</sup>	<b>33.3175</b>	CT-CH5-T/4xM25	
	10 – 17		<b>33.4126</b>	CT-K-VSH M25x10-17 MS	28				
	16 – 20.5		<b>33.4122</b>	CT-K-VSH M25x16-20,5 MS	30				
	17 – 21	32	<b>33.4124</b>	CT-K-VSH M32x17-21 MS	36	6+	<b>33.1386</b>	CT-TG6+ <sup>3)</sup>	
	21 – 25		<b>33.4125</b>	CT-K-VSH M32x21-25,5 MS	36				
5	10 – 17	25	<b>33.4126</b>	CT-K-VSH M25x10-17 MS	28	6 <sup>1)</sup>	<b>33.3186</b>	CT-CH6-T/6xM25 <sup>2)</sup>	
	17 – 21	32	<b>33.4124</b>	CT-K-VSH M32x17-21 MS	36	6+	<b>33.1386</b>	CT-TG6+ <sup>3)</sup>	
	21 – 25		<b>33.4125</b>	CT-K-VSH M32x21-25,5 MS	36				
4	17 – 21 21 – 25	32	<b>33.4125</b>	CT-K-VSH M32x21-25,5 MS	36	6 <sup>1)</sup>	<b>33.3206</b>	CT-CH6-T/4xM32	

<sup>1)</sup> IP2X

<sup>2)</sup> Close one gland opening with cap (not provided).

<sup>3)</sup> Special housings available on request.

Ø 8 MM POWER UNIT UP TO 142 A

# Contact carrier CT-E8-...

2-pole contact carriers made from resilient plastic.

To prevent flashover, there is a dividing wall between the two poles in the termination area.

CT-E8-2-IP2X

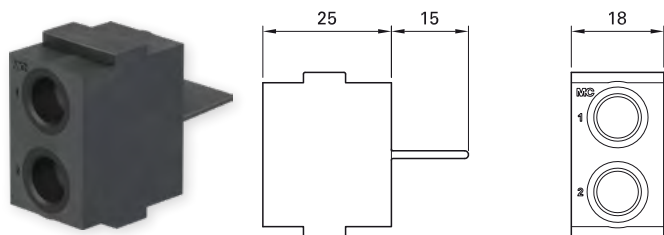

CT-E8-2

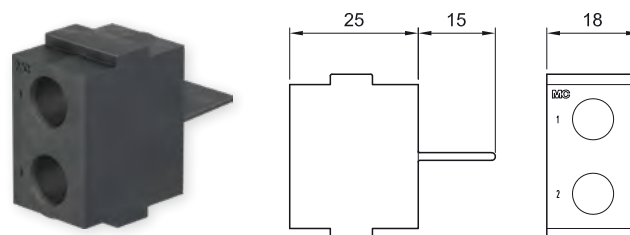

Order No.	Type	Description
33.4139	CT-E8-2-IP2X	Socket carrier (identification "B")
33.4000	CT-E8-2	Pin carrier

Technical data		
Number of poles	2	
For contact diameter	8 mm	
Pollution degree/overvoltage category	2/CAT II <sup>2)</sup>	3/CAT III
Rated voltage, crimp termination	1000 V	300 V
screw termination	600 V	300 V
Rated voltage UL	600 V	
Degree of protection (socket front)	IP2X	
Clearances and creepage distance	IEC 60664-1:2020 and UL 1977	
Limiting temperature (IEC 61984:2008), upper	+90 °C	
lower	-40 °C	
Contact carrier material	EPTR	

## Footnotes and technical data from pages 17:



Technical data	
Nominal-Ø socket/pin	8 mm
Average sliding force	5.5 N
Connector resistance	< 150 µΩ
Mating cycles	100,000
Vibrations	4.2 g/5 – 250 Hz (IEC 61373:2010) 10 g/10 – 500 Hz (IEC 60068-2-6)
Resistance to shocks	300 m/s <sup>2</sup> ; 18 ms (IEC 61373:2010)

\* Pin size same for all types of terminations.

<sup>1)</sup> IEC Rated current for fully occupied carriers. Derating diagrams for bundled cables see pages 129 – 134.

<sup>2)</sup> If the rated voltage at CAT II PD2 is higher than 600 V, only 1 contact per contact carrier permitted.

<sup>3)</sup> Cable lugs for smaller conductor cross sections (acc. to DIN 46234) are available commercially.

<sup>4)</sup> Arrangement of blind plugs with one contact per carrier. For contacts with crimp termination only.



Assembly instructions MA213-01

[www.staubli.com/electrical](http://www.staubli.com/electrical)

# ∅ 8 mm contacts

For contact carrier CT-E8-2-IP2X and CT-E8-2. Sockets fitted with MULTILAM.

**Type of termination:**

- Crimp termination (C) for Cu conductors (class 5 and 6)
- Screw termination (S) for cable lugs and contacts with M6 inside or outside thread

**Note:**

Screw terminations can not be fitted in housings due to space limitations.

CT-BP8/...



CT-SP8/...



CT-E8-2-IP2X

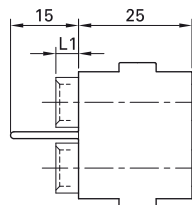

CT-E8-2

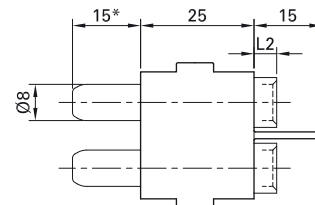

Order No.	Type	Socket	Pin	Surface	Conductor cross section		Rated current <sup>1)</sup>	Type of termination
					mm <sup>2</sup>	AWG		
33.0100 33.0500	CT-BP8/10 AG CT-SP8/10 AG	x	x		10	8	66	C
33.0101 33.0501	CT-BP8/10 AU CT-SP8/10 AU	x	x					
33.0102 33.0502	CT-BP8/16 AG CT-SP8/16 AG	x	x		16	6	89	C
33.0103 33.0503	CT-BP8/16 AU CT-SP8/16 AU	x	x					
33.0104 33.0504	CT-BP8/25 AG CT-SP8/25 AG	x	x		25	4	117	C
33.0105 33.0505	CT-BP8/25 AU CT-SP8/25 AU	x	x					
33.0106 33.0506	CT-BP8/35 AG CT-SP8/35 AG	x	x		35	2	142	C
33.0110 33.0510	CT-B8/M6 AG CT-S8/M6 AG	x	x					
33.0111 33.0511	CT-B8/M6 AU CT-S8/M6 AU	x	x		25	4	100	S
33.0120 33.0520	CT-B8/M6A AG CT-S8/M6A AG	x	x					
33.0121 33.0521	CT-B8/M6A AU CT-S8/M6A AU	x	x		35	2	120	S
33.4039	K-SCH35-6 <sup>3)</sup>	Cable lug						
33.4050	CT-BS8	Blind plug <sup>2), 4)</sup>						

Ø 6 MM AND Ø 8 MM PROTECTIVE EARTH (PE) UNIT

Contact carriers CT-E8/6-...

1-pole contact carrier made of resilient plastic. **Marked with a protective earth (PE) symbol.**

CT-E8/6-PE 

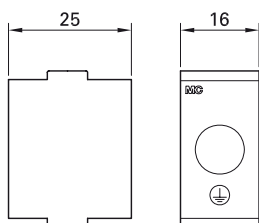

Order No.	Type	Description
33.4008	CT-E8/6-PE	Contact carrier with 

Technical data	
Number of poles	1
For contact diameter	8 mm/6 mm
Degree of protection (socket and plug front)	IP00
Limiting temperature (IEC 61984:2008), upper	+90 °C
lower	-40 °C
Contact carrier material	EPTR



E229145



Assembly instructions MA213-01

[www.staubli.com/electrical](http://www.staubli.com/electrical)

# Ø 8 mm first mate contacts with crimp termination

For contact carrier CT-E8/6-PE. Sockets fitted with MULTILAM. For protective earth (PE) purposes only; first mate against Ø 12 mm contacts.

**Type of termination:**  
Crimp termination (C) for Cu conductors (class 5 and 6)

CT-BP8/...PE-L AG



CT-SP8/...PE-L AG

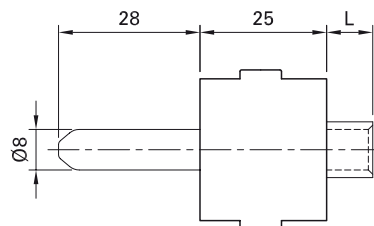

Order No.	Type	Socket	Pin	Surface	Conductor cross section		Short circuit current 3s kA	Type of termination
					mm <sup>2</sup>	AWG		
33.0205	CT-BP8/25/PE-L AG	x			25	4	1.3	C
33.0705	CT-SP8/25/PE-L AG		x		25	4	1.3	C
33.0206	CT-BP8/35/PE-L AG	x			35	2	1.6	C
33.0706	CT-SP8/35/PE-L AG		x		35	2	1.6	C
33.0207	CT-BP8/50/PE-L AG	x			50	1/0	1.6	C
33.0707	CT-SP8/50/PE-L AG		x		50	1/0	1.6	C

**Technical data**

Nominal-Ø socket/pin	8 mm
Average sliding force	6.5 N
Mating cycles	100,000



Assembly instructions MA213-01

[www.staubli.com/electrical](http://www.staubli.com/electrical)

# Ø 8 mm first mate contacts with M8 outside thread

For contact carrier CT-E8/6-PE, first mate. Sockets fitted with MULTILAM. For protective earth (PE) purposes only; first mate against Ø 12 mm contacts.

**Type of termination:**  
Screw termination (S) with an M8 male thread by means of a cable lug for Cu conductors (class 5 and 6)

**Note:**  
Screw terminations can not be fitted in housings due to space limitations.

CT-B8/M8A/PE-L AG



CT-S8/M8A/PE-L AG

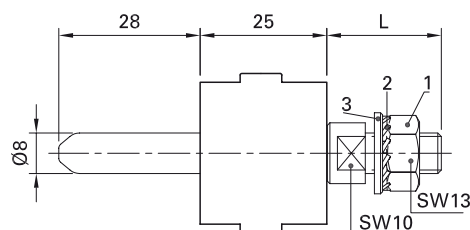

Order No.	Type	Socket	Pin	Surface	Conductor cross section		Short circuit current	Type of termination
					mm <sup>2</sup>	AWG		
33.0208	CT-B8/M8A/PE-L AG	x			25	4	1.3	S
33.0708	CT-S8/M8A/PE-L AG		x		35	2	1.6	
					50	1/0	1.6	
33.4117	K-SCH25-8 <sup>1)</sup>	Cable lug			25	4	1.3	
33.4116	K-SCH35-8 <sup>1)</sup>	Cable lug			35	2	1.6	
31002862	K-SCH50-8 <sup>1)</sup>	Cable lug			50	1/0	1.6	
33.4085	CT-DIP4/2 <sup>2)</sup>	Spacer						

**Individual parts (supplied with 33.0208 and 33.0708)**

Pos.	Order No.	Type	Remarks
1	08.0105	MU0,8D/M8 AG	6 kt. Hex. nut M8
2	08.0705	F/M8 DIN6798A BN781	Serrated lock washer F/M8
3	08.0305	U/M8 AG	Washer M8

Technical data	
Nominal-Ø socket/pin	8 mm
Average sliding force	5.5 N
Mating cycles	100,000

<sup>1)</sup> Cable lugs Cu/Sn according to DIN 46234 (class 5).  
<sup>2)</sup> Protective earth contacts with an M8 external thread must be separated from the Ø 12 mm contact by means of a CT-DIP4/2 spacer.

# First mate contacts Ø 6 mm and Ø 8 mm

For contact carriers CT-E8/6-PE, first mate. Sockets fitted with MULTILAM. For protective earth (PE) purposes only; first mate against Ø 6 mm and Ø 8 mm contacts.

**Type of termination:**

- Crimp termination (C) for Cu conductors (class 5 and 6)
- Screw termination (S) for cable lugs

**Note:**









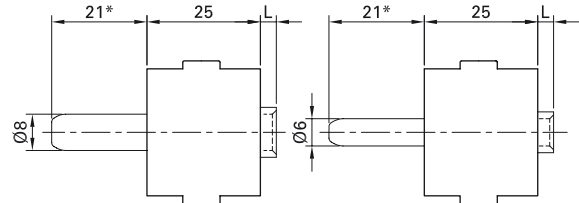

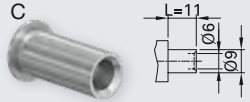

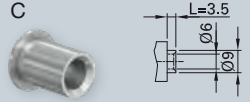
Screw terminations can not be fitted in housings due to space limitations.

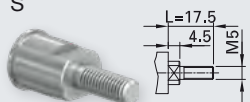
CT-B...PE AG 

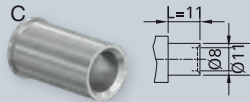

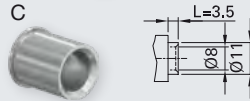
CT-S...PE AG 

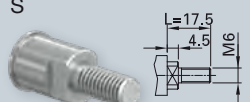

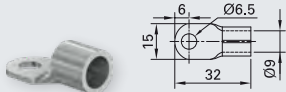
Order No.	Type	Socket	Pin	Surface	Conductor cross section		Short circuit current	Type of termination
					mm <sup>2</sup>	AWG		
33.0113	CT-BP6/16/PE AG	x			16	6	860	C 
33.0513	CT-SP6/16/PE AG		x		16	6	860	C 
33.0123	CT-B6/M5A/PE AG	x			6	10	320	S 
33.0523	CT-S6/M5A/PE AG		x		10	8	540	
					16	6	860	
					25	4	1600	
33.0114	CT-BP8/25/PE AG	x			25	4	1300	C 
33.0514	CT-SP8/25/PE AG		x		25	4	1300	C 
33.0119	CT-B8/M6A/PE AG	x			10	8	540	S 
33.0519	CT-S8/M6A/PE AG		x		16	6	860	
					25	4	1300	
					35	2	1600	
33.4039	K-SCH35-6 <sup>1)</sup>	Cable lug			35	2	fits with CT...8...	

**Technical data**

Nominal-Ø socket/pin	6 mm/8 mm
Average sliding force	7.5 N/5.5 N
Connector resistance	< 250 µΩ/< 150 µΩ
Mating cycles	100,000
Vibrations	4.2 g/5 – 250 Hz (IEC 61373:2010) 10 g/10 – 500 Hz (IEC 60068-2-6)
Resistance to shocks	300 m/s <sup>2</sup> ; 18 ms (IEC 61373:2010)

\* Pin size same for all types of terminations.

<sup>1)</sup> Cable lugs for smaller conductor cross sections (according to DIN 46234) are available commercially.

Ø 6 MM POWER UNIT UP TO 117 A

# Contact carrier CT-E6-2

2-pole contact carrier made of resilient plastic. To prevent flashover, there is a dividing wall between the two poles in the termination area.

CT-E6-2

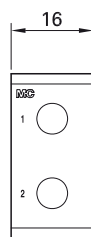
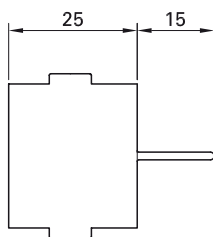
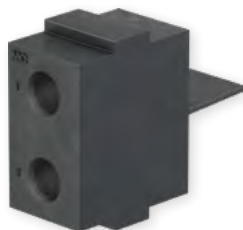

Order No.	Type
33.4006	CT-E6-2

Technical data		
Number of poles	2	
For contact diameter	6 mm	
Pollution degree/overvoltage category	2/CAT II	3/CAT III
Rated voltage, crimp termination	1000 V	500 V
Rated voltage, screw termination	600 V	300 V
Rated voltage UL	600 V	
Degree of protection (socket front)	IP2X	
Clearances and creepage distance	IEC 60664-1:2020	
Limiting temperature (IEC 61984:2008), upper	+90 °C	
Limiting temperature (IEC 61984:2008), lower	-40 °C	
Contact carrier material	EPTR	



E229145



Assembly instructions MA213-01

[www.staubli.com/electrical](http://www.staubli.com/electrical)

# ∅ 6 mm contacts

For contact carriers CT-E6-2. Sockets fitted with MULTILAM.

### Type of termination:

- Crimp termination (C) for Cu conductors (class 5 and 6)
- Screw termination (S) for cable lugs and contacts with an M5 inside or outside thread

### Note:

Screw terminations can not be fitted in housings due to space limitations.

CT-B6...



CT-S6...

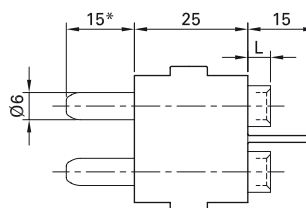

Order No.	Type	Socket	Pin	Surface	Conductor cross section		Rated current <sup>1)</sup>	Type of termination
					mm <sup>2</sup>	AWG		
33.0107 33.0507	CT-BP6/6 AG CT-SP6/6 AG	x	x		6	10	49	C
33.0108 33.0508	CT-BP6/10 AG CT-SP6/10 AG	x	x		10	8	66	C
33.0109 33.0509	CT-BP6/16 AG CT-SP6/16 AG	x	x		16	6	89	C
33.0112 33.0512	CT-B6/M5 AG CT-S6/M5 AG	x	x		6 10 16 25	10 8 6 4	49 66 89 117	S <sup>2)</sup>
33.0122 33.0522	CT-B6/M5A AG CT-S6/M5A AG	x	x		6 10 16 25	10 8 6 4	49 66 89 117	S <sup>2)</sup>
18.5502	MVS5	Blind plug						

### Technical data

Nominal-∅ socket/pin	6 mm
Average sliding force	7.5 N
Connector resistance	< 250 µΩ
Mating cycles	100,000
Vibrations	4.2 g/5 – 250 Hz (IEC 61373:2010) 10 g/10 – 500 Hz (IEC 60068-2-6)
Resistance to shocks	300 m/s <sup>2</sup> ; 18 ms (IEC 61373:2010)

\* Pin size same for all types of terminations.

<sup>1)</sup> IEC Rated current for fully occupied carriers. Derating diagrams for bundled leads, see pages 129 – 134.

<sup>2)</sup> Cable lugs according to DIN 46234 are available commercially.



Assembly instructions MA213-01

[www.staubli.com/electrical](http://www.staubli.com/electrical)

Ø 4 MM HIGH VOLTAGE UNIT UP TO 5 KV

# Contact carriers CT-E4-2/HV...

2-pole plastic contact carriers.

**Note:**

The maximum outside diameter of the cable insulation is 9.05 mm.

CT-E4-2/HV-B

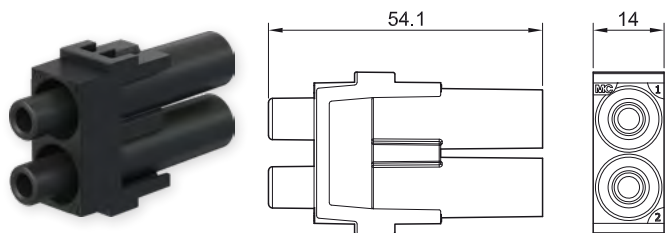

CT-E4-2/HV-S

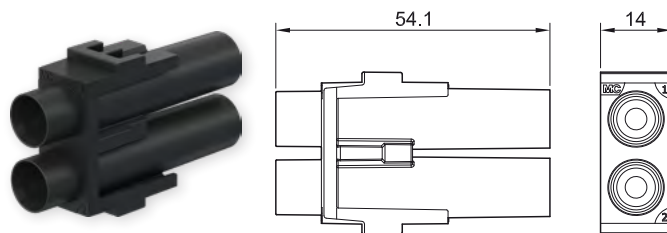

Order No.	Type	Description
33.4159	CT-E4-2/HV-B	2-pole socket carrier
33.4559	CT-E4-2/HV-S	2-pole pin carrier

Technical data	
Number of poles	2
For contact diameter	4 mm
Pollution degree	2
Rated voltage phase-to-earth	2.9 kV
Rated voltage phase-to-phase	5 kV
Test Voltage 1 min., 50/60 Hz; phase-to-earth	6.6 kV
Test Voltage 1 min., 50/60 Hz; phase-to-phase	13.7 kV
Degree of protection (in mated condition)	IP2X
Limiting temperature (IEC 61984:2008), upper	+125 °C
lower	-40 °C
Contact carrier material	PA



Assembly instructions MA213-05

[www.staubli.com/electrical](http://www.staubli.com/electrical)



E229145

# Ø 4 mm/HV

For contact carrier CT-E4-2/HV-... Sockets fitted with MULTILAM.

- Crimp termination (C) for Cu conductors (class 5 and 6).

- Connector without breaking capacity (COC)
- The connector must not be connected or disconnected when live or under load

**Type of termination:**

- Crimp termination (C) for Cu high voltage conductors 2.5 mm<sup>2</sup> up to 10 mm<sup>2</sup>, followed by insulation with shrink tubing CT-HV-SRTU.

**Note:**

- All data regarding ratings apply to the mated condition

CT-BP4/...-HV AU



CT-SP4/...-HV AU

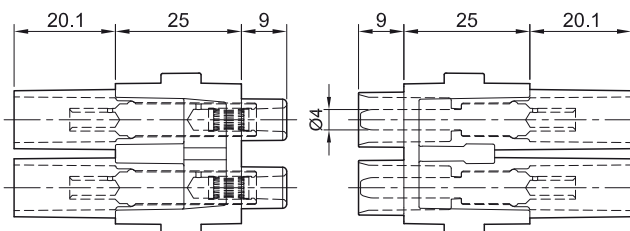

Order No.	Type	Socket	Pin	Surface	Conductor cross section		Rated current <sup>1)</sup> 2 poles	Type of termination
					mm <sup>2</sup>	AWG		
33.0256 33.0756	CT-BP4/2,5-4-HV AU CT-SP4/2,5-4-HV AU	x	x		2.5 – 4	14 12	53 A	
33.0257 33.0757	CT-BP4/6-HV AU CT-SP4/6-HV AU	x	x		6	10	61 A	
33.0258 33.0758	CT-BP4/10-HV AU CT-SP4/10-HV AU	x	x		10	8	81 A	

**Accessories**

33.5666	CT-HV-SRTU	Shrink tube 45 mm (length) is included in the scope of delivery of the contact carrier. When ordering contacts as a spare part, the shrink tubing must be ordered separately in the appropriate quantity.	
---------	------------	---	--

Technical data	
Nominal-Ø socket/pin	4 mm
Average sliding force	8 N
Connector resistance	< 1.1 mΩ
Mating cycles	100,000
Vibrations	4.2 g/5 – 250 Hz (IEC 61373:2010) 10 g/10 – 500 Hz (IEC 60068-2-6)
Resistance to shocks	30 g/18 ms (IEC 61373:2010)



Assembly instructions MA213-05

www.staubli.com/electrical

<sup>1)</sup> IEC Rated current for fully occupied carriers. Derating diagrams for bundled leads, see pages 129 – 134. For details on UL see page 137.

Ø 3 MM POWER UNIT UP TO 39 A

# Contact carriers CT-E3-3, CT-E3-3/PCB

3-pole contact carriers made of resilient plastic. Different contact carriers for crimping (C) or flow-soldering (PCB) termination.

CT-E3-3/B

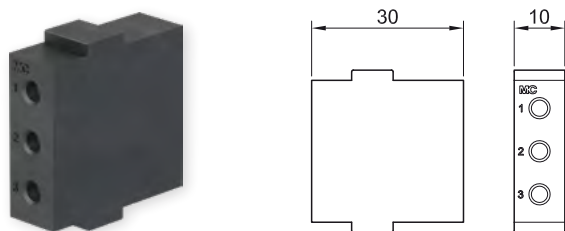

CT-E3-3

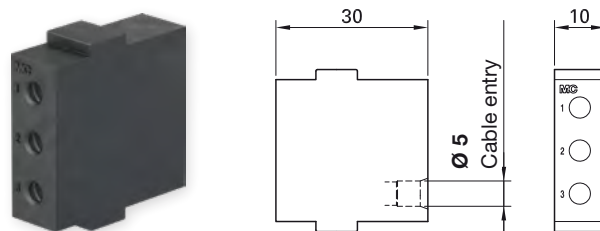

CT-E3-3/PCB/B

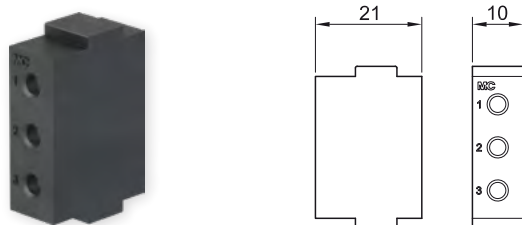

CT-E3-3/PCB

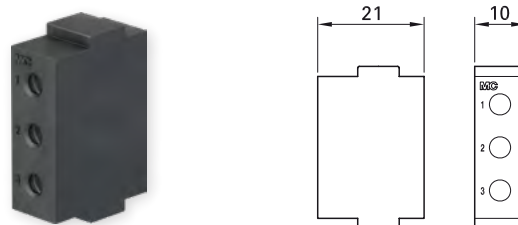

Order No.	Type	Description
33.4143	CT-E3-3/B	Socket carrier for crimping
33.4001	CT-E3-3	Pin carrier for crimping
33.4133	CT-E3-3/PCB/B	Socket carrier for flow-soldering
33.4004	CT-E3-3/PCB	Pin carrier for flow-soldering

Technical data		
Number of poles	3	
For contact diameter	3 mm	
Pollution degree/overvoltage category	2/CAT II	3/CAT III
Rated voltage	600 V <sup>1), 2)</sup>	300 V <sup>2)</sup> (CT-E3-3), 250 V (CT-E3-3/PCB)
Rated voltage UL	600 V	
Max. flow-soldering temperature/time	260 °C/3 s	
Degree of protection (socket front)	IP2X	
Clearances and creepage distance	IEC 60664-1:2020	
Limiting temperature (IEC 61984:2008), upper	+90 °C	
lower	-40 °C	
Contact carrier material	EPTR	

<sup>1)</sup> 600 V line to neutral, 690 V three phase according IEC 60664:2007.

<sup>2)</sup> Rated voltage levels for pollution degree 2/overvoltage category CAT II above 600 V and up to 1000 V, along with rated voltage levels for pollution degree 3/overvoltage category CAT III above 300 V and up to 400 V, are possible with CT-E3-3 carriers depending on configuration type. This does not apply to CT-E3-3/PCB carriers. Please refer to assembly instructions MA213 for further details.



Assembly instructions MA213-01

[www.staubli.com/electrical](http://www.staubli.com/electrical)



# ∅ 3 mm contacts

For contact carriers CT-E3-3... Sockets fitted with MULTILAM.

**Type of termination:**

- Crimp termination (C) for Cu conductors (class 5 and 6)
- Flow-soldering (PCB)

CT-BP3...



CT-SP3...

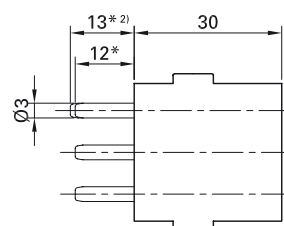

Order No.	Type	Socket	Pin	Surface	Conductor cross section		Rated current <sup>1)</sup>	Type of termination
					mm <sup>2</sup>	AWG		
<b>33.0131</b>	CT-BP3/2,5-4 AU	x			2.5 4	14 12	26 39	C
<b>33.0533</b> <b>33.0531</b>	CT-SP3/2,5-4L AU <sup>2)</sup> CT-SP3/2,5-4K AU		x x		2.5 – 4	14/12	26 – 39	
<b>33.0137</b>	CT-B3/PCB-K AU	x					35	PCB <sup>3)</sup>
<b>33.0537</b> <b>33.0535</b>	CT-S3/PCB-L AU <sup>2)</sup> CT-S3/PCB-K AU		x x				35 35	
<b>18.5501</b>	MVS3	Blind plug						

Technical data	
Nominal-∅ socket/pin	3 mm
Average sliding force	8 N
Connector resistance	< 1.1 mΩ
Mating cycles	100,000
Vibrations	4.2 g/5 – 250 Hz (IEC 61373:2010) 10 g/10 – 500 Hz (IEC 60068-2-6)
Resistance to shocks	300 m/s <sup>2</sup> ; 18 ms (IEC 61373:2010)

\* Pin sizes same for all type of terminations.

<sup>1)</sup> IEC Rated current for fully occupied carriers. Derating diagrams for bundled leads, see pages 129 – 134.

<sup>2)</sup> Longer type of pin mates first.

<sup>3)</sup> For drilling plans, see assembly instructions MA213-01.



Assembly instructions MA213-01

[www.staubli.com/electrical](http://www.staubli.com/electrical)

# Contact carrier CT-E3-2+PE

3-pole contact carrier made of resilient plastic.

One pole functions as a protective earth (PE) contact and is **marked with a protective earth (PE) symbol**.

CT-E3-2+PE/B 

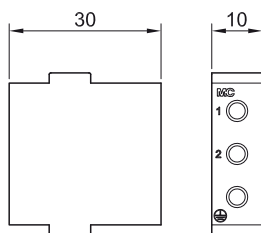

CT-E3-2+PE/S 

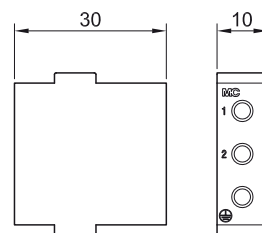

Order No.	Type	Description
33.4149	CT-E3-2+PE/B	Socket contact carrier for crimping
33.4132	CT-E3-2+PE/S	Pin contact carrier for crimping

Technical data		
Number of poles	2 + 1 PE	
For contact diameter	3 mm	
Pollution degree/overvoltage category	2/CAT II	3/CAT III
Rated voltage	600 V <sup>1), 2)</sup>	300 V <sup>2)</sup>
Rated voltage UL	600 V	
Degree of protection (socket front)	IP2X <sup>3)</sup>	
Clearances and creepage distance	IEC 60664-1:2020	
Limiting temperature (IEC 61984:2008), upper	+90 °C	
lower	-40 °C	
Contact carrier material	EPTR	



Assembly instructions MA213-01

[www.staubli.com/electrical](http://www.staubli.com/electrical)

<sup>1)</sup> 600 V line to neutral, 690 V three phase according IEC 60664:2007.

<sup>2)</sup> Rated voltage levels for pollution degree 2/overvoltage category CAT II above 600 V and up to 1000 V, along with rated voltage levels for pollution degree 3/overvoltage category CAT III above 300 V and up to 400 V, are possible with CT-E3-2+PE carriers depending on configuration type. Please refer to assembly instructions MA213 for further details.

<sup>3)</sup> Except for PE contact.

# ∅ 3 mm contacts

For contact carriers CT-E3-2+PE. Sockets fitted with MULTILAM. Protective earth (PE) contacts and standard contacts. PE contacts for protective earth (PE) purposes only.<sup>1)</sup>

**Type of termination:**





- Crimp termination (C) for Cu conductors (class 5 and 6)

CT-BP3/2,5-4/PE AU 

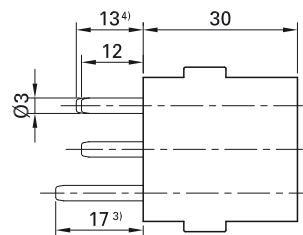

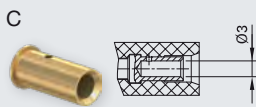
CT-SP3/2,5-4/PE AU 



Order No.	Type	Socket	Pin	Surface	Conductor cross section		Rated current <sup>2)</sup>	Type of termination	
					mm <sup>2</sup>	AWG			
33.0129	CT-BP3/2,5-4/PE AU <sup>3)</sup>	x			2.5 4	14 12	- <sup>1)</sup> - <sup>1)</sup>		
33.0529	CT-SP3/2,5-4/PE AU <sup>3)</sup>		x		2.5 4	14 12	- <sup>1)</sup> - <sup>1)</sup>		
33.0131	CT-BP3/2,5-4 AU	x			2.5 4	14 12	26 39		
33.0533 33.0531	CT-SP3/2,5-4L AU <sup>4)</sup> CT-SP3/2,5-4K AU		x x		2.5 4	14 12	26 39		
18.5501	MVS3	Blind plug							

Technical data	
Nominal-∅ socket/pin	3 mm
Average sliding force	8 N
Connector resistance	< 1.1 mΩ
Mating cycles	100,000
Vibrations	4.2 g/5 – 250 Hz (IEC 61373:2010) 10 g/10 – 500 Hz (IEC 60068-2-6)
Resistance to shocks	300 m/s <sup>2</sup> ; 18 ms (IEC 61373:2010)

<sup>1)</sup> Short circuit current 3s  
2.5 mm<sup>2</sup>: 135 A  
4 mm<sup>2</sup>: 216 A

<sup>2)</sup> IEC Rated current for fully occupied carriers. Derating diagrams for bundled leads, see pages 129 – 134.

<sup>3)</sup> Protective earth (PE) contact.  
<sup>4)</sup> Longer type of pin mates first.



Assembly instructions MA213-01

[www.staubli.com/electrical](http://www.staubli.com/electrical)

Ø 1.5 MM HIGH VOLTAGE UNIT UP TO 2.5 KV

# Contact carrier CT-E1,5-4/HV...

4-pole high voltage module up to 2.5 kV for general industry, railway, and testing applications.

**Features:**

- Space saving 4-pole solution
- Railway compliant material
- Resistance to shock and vibrations
- Tool-free insertion of contacts in carrier

CT-E1,5-4/HV-B

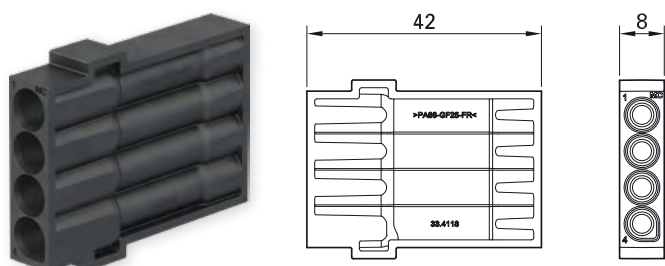

CT-E1,5-4/HV-S

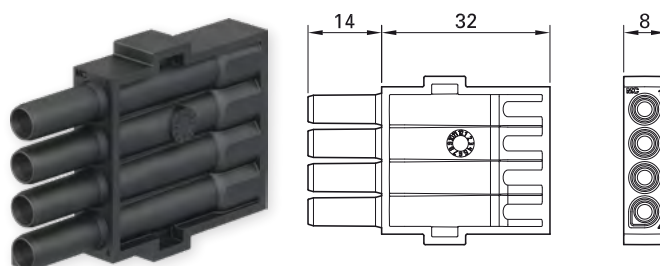

Order No.	Type	Designation
33.4118	CT-E1,5-4/HV-B	4-pole socket carrier
33.4518	CT-E1,5-4/HV-S	4-pole pin carrier

Technical data		
Number of poles	4	
For contact diameter	1.5 mm	
Pollution degree/overvoltage category	2/CAT II	3/CAT III
Rated voltage	U <sub>AC</sub> 2000 V U <sub>DC</sub> 2500 V	1000 V
Rated voltage UL	600 V	
Test voltage r.m.s. 1 min., 50/60 Hz	6.6 kV	
Degree of protection (socket front)	IP2X	
Limiting temperature (IEC 61984:2008), upper	+125 °C	
lower	-40 °C	
Contact carrier material	PA	
Fire and smoke compliance	EN 45545-2 (HL2 R22)	



E229145



Assembly instructions MA213-05

[www.staubli.com/electrical](http://www.staubli.com/electrical)

# Ø 1.5 mm/HV

For contact carrier CT-E1,5-4/HV-... Sockets fitted with MULTILAM.

### Type of termination:

Crimp termination (C) for Cu high voltage conductors 0.5 mm<sup>2</sup> – 1.5 mm<sup>2</sup>.

Crimp termination (C) for Cu conductors (class 5 and 6).

### Note:

- For rated voltage above AC 1000 V, DC 1500 V the connector must not be connected or disconnected when live or under load. Apply voltage only in mated condition.

- High voltage module 2.5 kV used up to max. 30 kHz. Only to be used with plastic rails (CT-BS Order No.: 33.5606-...).

CT-BP1,5/0,5-1,5-HV

CT-SP1,5/0,5-1,5-HV

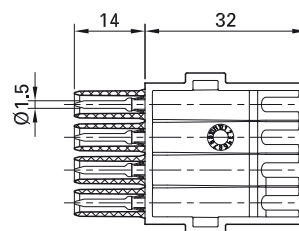
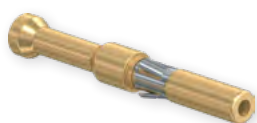

Order No.	Type	Socket	Pin	Surface	Conductor cross section		Rated current <sup>1)</sup> A	Type of termination
					mm <sup>2</sup>	AWG		
33.0169	CT-BP1,5/0,5-1,5-HV	x	x		0.5	20	7	
33.0569	CT-SP1,5/0,5-1,5-HV				0.75	18	12	
					1	-	19	
					1.5	16	25	

Technical data	
Nominal-Ø socket/pin	1.5 mm
Average sliding force	2 N
Connector resistance	< 1.3 mΩ
Mating cycles	100,000
Vibrations and shock	IEC 61373:2010 category 1B

### Required tools

For extraction tool CT-AWZ-2,5HV, Order No. 33.3006 please refer to MA213-05.



Assembly instructions MA213-05

[www.staubli.com/electrical](http://www.staubli.com/electrical)

<sup>1)</sup> IEC Rated current for fully occupied carriers. Derating diagrams for bundled leads, see pages 129 – 134.

Ø 1.5 MM SIGNAL UNIT UP TO 19 A

# Contact carrier CT-E1,5-5

5-pole contact carrier made of resilient plastic.

CT-E1,5-5

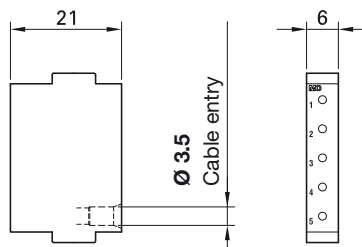

Order No.	Type
33.4005	CT-E1,5-5

Technical data		
Number of poles	5	
For contact diameter	1.5 mm	
Pollution degree/overvoltage category	2/CAT II	3/CAT III
Rated voltage	600 V	250 V
Rated voltage UL	600 V	
Max. flow-soldering temperature/time	260 °C/3 s	
Degree of protection (socket front)	IP2X	
Clearances and creepage distance	IEC 60664-1:2020	
Limiting temperature (IEC 61984:2008), upper	+90 °C	
lower	-40 °C	
Contact carrier material	EPTR	



E229145



Assembly instructions MA213-01

[www.staubli.com/electrical](http://www.staubli.com/electrical)

# Ø 1.5 mm contacts

For contact carriers CT-E1,5-5. Sockets fitted with MULTILAM.

### Type of termination:

- Crimp termination (C) for Cu conductors (class 5) (CT-...P1,5/1,5... also for class 6)
- Flow-soldering (PCB)

CT-BP1,5...



CT-SP1,5...

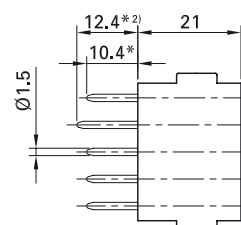

Order No.	Type	Socket	Pin	Surface	Conductor cross section		Rated current <sup>1)</sup>	Type of termination
					mm <sup>2</sup>	AWG		
33.0153	CT-BP1,5LAV/0,5-1,5 AU	x			0.5	20	6	C
					0.75	18	10	
					1.0	18	13	
					1.5	16	19	
33.0551	CT-SP1,5/0,5-1,5L AU <sup>2)</sup>		x		0.5	20	6	C
33.0550	CT-SP1,5/0,5-1,5K AU		x		0.75	18	10	
					1.0	18	13	
					1.5	16	19	
33.0156	CT-BP1,5LAV/1,5 AU <sup>3)</sup>	x			1.5	16	19	C
33.0555	CT-SP1,5/1,5K AU <sup>3)</sup>		x		1.5	16	19	C
33.0157	CT-B1,5LAV/PCB AU	x					10	PCB <sup>4)</sup>
33.0553	CT-S1,5/PCB-L AU <sup>2)</sup>		x				10	PCB <sup>4)</sup>
33.0552	CT-S1,5/PCB-K AU		x				10	
18.5504	MVS1	Blind plug						

Technical data	
Nominal-Ø socket/pin	1.5 mm
Average sliding force	2 N
Connector resistance	< 1.1 mΩ
Mating cycles	100,000
Vibrations	4.2 g/5 – 250 Hz (IEC 61373:2010) 10 g/10 – 500 Hz (IEC 60068-2-6)
Resistance to shocks	300 m/s <sup>2</sup> ; 18 ms (IEC 61373:2010)



Assembly instructions MA213-01

[www.staubli.com/electrical](http://www.staubli.com/electrical)

\* Pin size same for all types of terminations.

<sup>1)</sup> IEC Rated current for fully occupied carriers. Derating diagrams for bundled leads, see pages 129 – 134.

<sup>2)</sup> Longer type of pin mates first.

<sup>3)</sup> For Cu conductors (class 6).

<sup>4)</sup> For drilling plans, see assembly instructions MA213-01.

Ø 1 MM SIGNAL UNIT UP TO 6 A

# Contact carriers CT-E1-26/...

26-pole contact carrier made of resilient plastic. Different designs for pins and sockets.

For suitable contacts, see page 37.

CT-E1-26/B

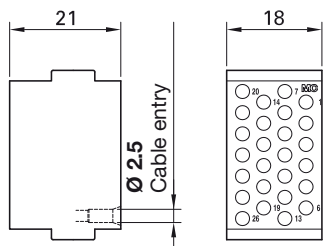

CT-E1-26/S

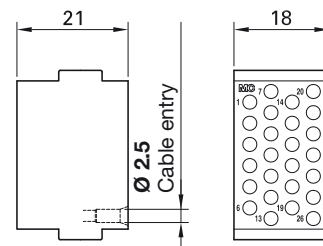

Order No.	Type	Description
33.4002	CT-E1-26/B	Socket carrier (identification "B")
33.4003	CT-E1-26/S	Pin carrier (identification "S")

Technical data		
Number of poles	26	
For contact diameter	1 mm	
Pollution degree/overvoltage category	2/CAT II	3/CAT III
Rated voltage	300 V	150 V
Rated voltage UL	250 V	
Max. flow-soldering temperature/time	260 °C/3 s	
Degree of protection (socket front)	IP2X	
Clearances and creepage distance	IEC 60664-1:2020	
Limiting temperature (IEC 61984:2008), upper	+90 °C	
lower	-40 °C	
Contact carrier material	EPTR	



E229145



Assembly instructions MA213-01

[www.staubli.com/electrical](http://www.staubli.com/electrical)

# Contact carriers CT-E1-15/...

15-pole contact carrier made of resilient plastic. Different designs for pins and sockets.

For suitable contacts, see page 37.

**Note:**

When using a spacer, CT-DIP1 K; 33.4063 is to be selected.

**CT-E1-15/B**

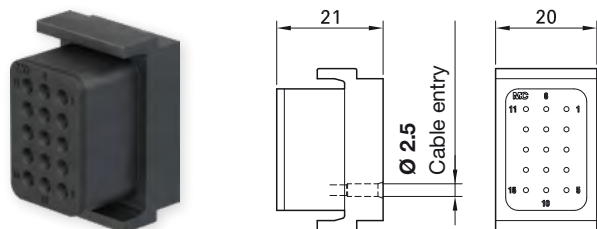

**CT-E1-15/S**

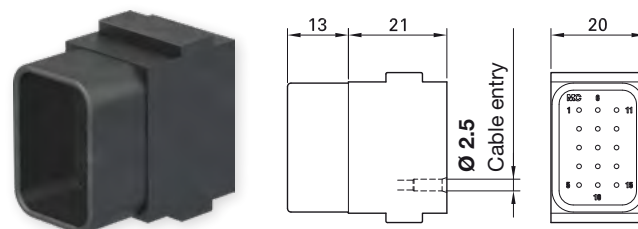

Order No.	Type	Description
33.4022	CT-E1-15/B	Socket carrier (identification "B")
33.4023	CT-E1-15/S	Pin carrier (identification "S")

Technical data		
Number of poles	15	
For contact diameter	1 mm	
Pollution degree/overvoltage category	2/CAT II	3/CAT III
Rated voltage	300 V	150 V
Rated voltage UL	250 V	
Max. flow-soldering temperature/time	260 °C/3 s	
Degree of protection (socket front)	IP2X	
Clearances and creepage distance	IEC 60664-1:2020	
Limiting temperature (IEC 61984:2008), upper	+90 °C	
lower	-40 °C	
Contact carrier material	PA & EPTR	



E229145



Assembly instructions MA213-01

[www.staubli.com/electrical](http://www.staubli.com/electrical)

# Contact carrier CT-E1-6

6-pole contact carrier made of resilient plastic. For suitable contacts, see page 37.

CT-E1-6

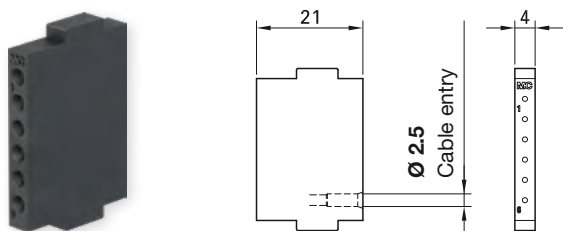

Order No.	Type
33.4014	CT-E1-6

Technical data		
Number of poles	6	
For contact diameter	1 mm	
Pollution degree/overvoltage category	2/CAT II	3/CAT III
Rated voltage	300 V	150 V
Rated voltage UL	250 V	
Max. flow-soldering temperature/time	260 °C/3 s	
Degree of protection (socket front)	IP2X	
Clearances and creepage distance	IEC 60664-1:2020	
Limiting temperature (IEC 61984:2008), upper	+90 °C	
lower	-40 °C	
Contact carrier material	EPTR	



E229145



Assembly instructions MA213-01

[www.staubli.com/electrical](http://www.staubli.com/electrical)

# Ø 1 mm contacts

For contact carriers CT-E1-26/..., CT-E1-15/..., and CT-E1-6. Sockets fitted with MULTILAM.

**Type of termination:**

- Crimp termination (C) for Cu conductors (class 5 and 6)
- Flow-soldering (PCB)

CT-BP1...



CT-SP1...



CT-E1-26/...

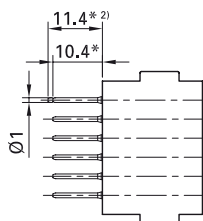

CT-E1-15/...

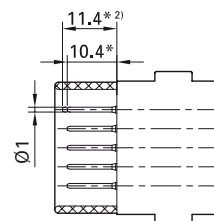

CT-E1-6

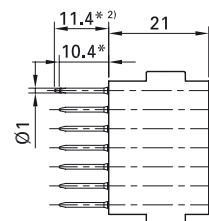

Order No.	Type	Socket	Pin	Surface	Conductor cross section		Rated current <sup>1)</sup>	Type of termination
					mm <sup>2</sup>	AWG		
33.0141	CT-BP1/0,25-0,75 AU	x			0.25	24	3	C 
33.0143	CT-BP1ET/0,25-0,75 AU	x			0.5	20	4	
					0.75	18	6	
33.0543	CT-SP1/0,25-0,75L AU <sup>2)</sup>		x		0.25	24	3	
33.0541	CT-SP1/0,25-0,75K AU		x		0.5	20	4	
					0.75	18	6	
33.0145	CT-B1/PCB AU	x					5	PCB <sup>3)</sup> 
33.0146	CT-B1ET/PCB AU	x					5	
33.0547	CT-S1/PCB-L AU <sup>2)</sup>		x				5	
33.0545	CT-S1/PCB-K AU		x				5	
33.4051	CT-BS1	Blind plug						

Technical data		
	CT-BP... & CT-B...	CT-BP1ET... & CT-B1ET...
Nominal-Ø socket/pin	1 mm	1 mm
Average sliding force	2 N	0.6 N
Connector resistance	< 1.6 mΩ	< 3 mΩ
Mating cycles	5000	100,000
Vibrations	4.2 g/5 – 250 Hz (IEC 61373:2010) 10 g/10 – 500 Hz (IEC 60068-2-6)	
Resistance to shocks	300 m/s <sup>2</sup> ; 18 ms (IEC 61373:2010)	



Assembly instructions MA213-01

www.staubli.com/electrical

\* Pin size same for all types of terminations.

<sup>1)</sup> IEC Rated current for fully occupied carriers. Derating diagrams for bundled leads, see pages 129 – 134.

<sup>2)</sup> Longer type of pin mates first.

<sup>3)</sup> For drilling plans, see assembly instructions MA213-01.

Ø 0.6 MM SIGNAL UNIT UP TO 2 A

# Contact carriers CT-E0,6-20/...

20-pole contact carrier made of plastic. Different designs for pins and sockets. The inner wall of the pin carrier protects the contacts from mechanical damage. The contact

carrier is mechanically coded to prevent incorrect mating.

**Note:**

In combination with the contact carrier CT-E0,6-20/..., compensator CT-DIP1,3-3,4 might be needed to fill gaps in the CombiTac.

CT-E0,6-20/B

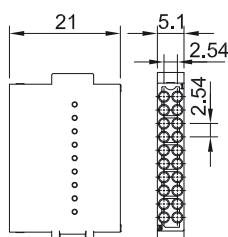

CT-E0,6-20/S

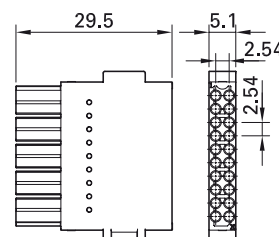

Order No.	Type	Description
33.4073	CT-E0,6-20/B	Socket carrier (identification "B")
33.4072	CT-E0,6-20/S	Pin carrier (identification "S")

Technical data		
Number of poles	20	
For contact diameter	0.6 mm	
Pollution degree/overvoltage category	2/CAT II	3/CAT III
Rated voltage	150 V	50 V
Max. flow-soldering temperature/time	260 °C/3 s	
Degree of protection (socket front)	IP2X	
Limiting temperature (IEC 61984:2008), upper	+90 °C	
lower	-40 °C	
Contact carrier material	LCP	



Assembly instructions MA213-01

[www.staubli.com/electrical](http://www.staubli.com/electrical)

# Ø 0.6 mm contacts

For contact carriers CT-E0,6-20/...

**Type of termination:**

- Crimp termination (C) for Cu conductors
- Soldering (L) for Cu conductors
- Flow-soldering (PCB) for printed circuit boards

CT-B...



CT-S...

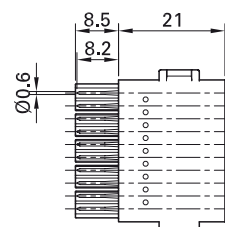

Order No.	Type	Socket	Pin	Surface	Conductor cross section		Rated current <sup>1)</sup>	Type of termination
					mm <sup>2</sup>	AWG		
<b>33.0126</b> <b>33.0526</b>	CT-BP0,6ET/0,14-0,25 AU CT-SP0,6/0,14-0,25 AU	x	x		0.14 0.25	26 24	1.4 2	C
<b>33.0125</b> <b>33.0525</b>	CT-B0,6ET/LO AU CT-S0,6/LO AU	x	x		0.14 0.25	26 24	1.4 2	L
<b>33.0124</b> <b>33.0524</b>	CT-B0,6ET/PCB AU CT-S0,6/PCB AU	x	x		0.14 0.25	26 24	1.4 2	PCB

**Technical data**

Nominal-Ø pin/socket	0.6 mm
Average sliding force	0.25 N
Connector resistance	< 6 mΩ
Mating cycles	100,000

<sup>1)</sup> IEC Rated current for fully occupied carriers. Derating diagrams for bundled leads, see pages 129 – 134.



Assembly instructions MA213-01

[www.staubli.com/electrical](http://www.staubli.com/electrical)

# LAST MATE FIRST BREAK MODULE

## Module CT-LMFB/...

Last Mate First Break (LMFB) contacts are intended for monitoring purposes, and show whether a CombiTac is fully connected or not. Each CombiTac LMFB module consists

of two LMFB contacts placed at the edge positions of a carrier. Suitable for panel mount and housing applications.

CT-LMFB/B

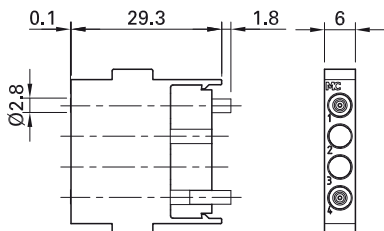

CT-LMFB/S

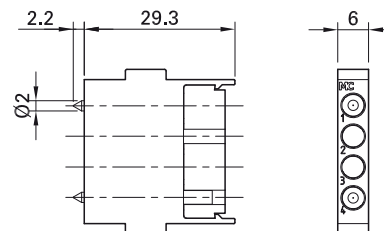

Order No.	Type	Description
33.2257	CT-LMFB/B	Socket module
33.2657	CT-LMFB/S	Pin module

### Technical data

Contact carrier material	PA
Limiting temperature (IEC 61984:2008), upper	+90 °C
lower	-40 °C

Rails ≤ 90 mm<sup>1)</sup>



E229145



Assembly instructions MA213-07

[www.staubli.com/electrical](http://www.staubli.com/electrical)

# Last Mate First Break contacts CT-LMFB-...

To be used with contact carrier CT-E-4GOF for monitoring the connection status of electrical contacts Ø 1.5 mm – Ø 12 mm.

The LMFB modules are delivered including the LMFB modules. Please note the information on the previous page.

**Type of termination:**

- Crimp termination (C) for Cu conductors (class 5)
- Pressure contacts fitted with MULTILAM

CT-LMFB-B2/0,5-1,5 AU

CT-LMFB-S2/0,5-1,5 AU

Socket side

Pin side

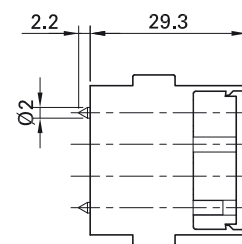
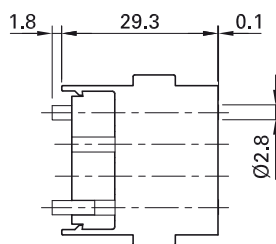

Order No.	Type	Socket	Pin	Surface	Conductor cross section		Type of termination
					mm <sup>2</sup>	AWG	
33.0134	CT-LMFB-B2/0,5-1,5 AU	x	x		0.5	20	
33.0534	CT-LMFB-S2/0,5-1,5 AU				0.75	18	
					1.0	18	
					1.5	16	
33.4080	CT-BSGOF <sup>2)</sup>	Blind plug					

**Accessories**

33.4157	CT-SC0,8	Spacer clamp			For housing size 1, 6 and pedestal housing size 5 <sup>3)</sup>		
---------	----------	--------------	--	--	---	--	--

Technical data	
Rated voltage/system voltage	U <sub>DC</sub> 29.5 V
Max. signal current	100 mA
Average springforce per contact	14 N
Mating cycles	100,000 <sup>4)</sup>
Vibrations	3.1 g/5 – 250 Hz (IEC 61373:2010)
Resistance to shocks	300 m/s <sup>2</sup> ; 18 ms (IEC 61373:2010)

<sup>1)</sup> Please consult Stäubli sales team regarding LMFB modules for Rails > 90 mm

<sup>2)</sup> We recommend filling the two empty slots of the contact carrier with blind plugs.

<sup>3)</sup> For housing size 1, 6 and pedestal housing size 5, a spacer clamp is used if improvement of tolerance levels is required. The space clamp is not included in the delivery and can be ordered separately if needed. For more information please refer to MA213-07 page 8.

<sup>4)</sup> LMFB contacts are not suitable for inductive (e.g. relays) or capacitive loads. In such cases, arcing at the LMFB contacts during connecting/disconnecting may reduce the expected mating cycles of LMFB contacts.



Assembly instructions MA213-07

www.staubli.com/electrical

COAXIAL UNIT 6 GHz

Contact carrier

The Coaxial unit 6 GHz is used for data as well as digital audio and video transmission. Two types of termination are possible, crimp and SMA.

There are two crimp versions available, one for RG58 and one for RG316/U, RG174 and RG188 cables, and a SMA termination version for various cable types up to 6 GHz levels.

Features:

- Suitable for various 50 Ω RG cable types up to 6 GHz (depending on RG cable type)
- Crimp for RG58 cables up to 2.4 GHz
- Crimp for RG316/U, RG174, RG188 cables up to 2.4 GHz
- SMA for RG58, RG316/U, RG174, RG188 and other cables up to 6 GHz

- UL 1977 and Railway standard compliant
- Resistance to shock and vibrations
- Applications: data transmission, digital audio and video, HF measurement, radio communication.

CT-E-COAX-1

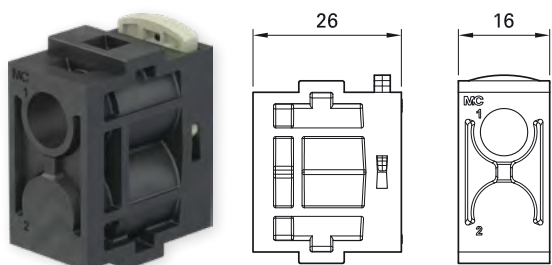

CT-E-COAX-2

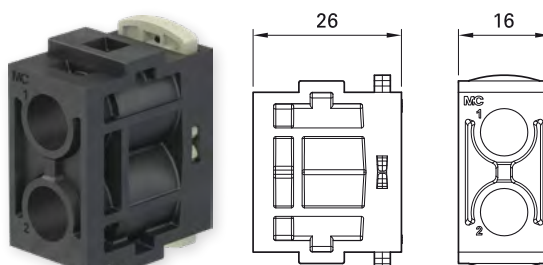

CT-RC-COAX



Order No.	Type	Designation
33.4180	CT-E-COAX-1	One pole coax carrier
33.4181	CT-E-COAX-2	Two pole coax carrier

Individual part (supplied with 33.4180 and 33.4181)

33.4182	CT-RC-COAX	Retaining clip (one retaining clip is required per contact)
---------	------------	---

Technical data	
Number of poles CT-E-COAX-1	1
CT-E-COAX-2	2
For connectors	Coaxial crimp and SMA
Pollution degree	2
Limiting temperature (IEC 61984:2008)	-40 °C...+90 °C
Contact carrier material	PA
Fire and smoke compliance	EN 45545-2 (HL3 R22 – R23)



Assembly instructions MA213-11

www.staubli.com/electrical



# Coaxial connectors

For contact carriers CT-E-COAX-1 and CT-E-COAX-2.

**Type of termination:**

- Crimp termination (C)
- SMA Termination (SMA)

CT-B-COAX-RG316/U



CT-S-COAX-RG316/U

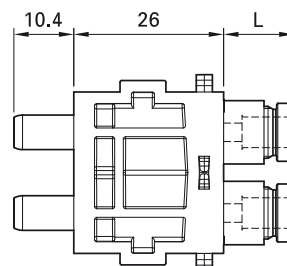

Order No.	Type	Socket	Pin	Suitable for cable types	Type of termination
33.0230 33.0630	CT-B-COAX-RG316/U CT-S-COAX-RG316/U	×	×	RG316/U, RG174, RG188	C 
33.0231 33.0631	CT-B-COAX-RG58 CT-S-COAX-RG58	×	×	RG58	C 
33.0250 33.0750	CT-B-COAX-SMA CT-S-COAX-SMA	×	×	RG58, RG316/U, RG174, RG188, other 50 Ω RG cable types up to 6 GHz	SMA 

**Technical data**

Average sliding force per contact	Crimp: 5 N SMA: 8 N
Max. frequency	Crimp: 2.4 GHz SMA: 6 GHz
Voltage standing wave ratio (VSWR)	Crimp: 1.4 at 2.4 GHz SMA: 1.3 at 6 GHz
Rated voltage	UL 250 V, IEC 300 V
Rated current	250 mA
Impedance	50 Ω
Mating cycles	100,000
Vibrations and shock	IEC 61373:2010 category 1B
Degree of protection (socket front)	IP2X



Assembly instructions MA213-11

[www.staubli.com/electrical](http://www.staubli.com/electrical)

COAXIAL UNIT 1.5 GHZ

# Contact carrier CT-E8-2

2-pole contact carrier made of resilient plastic.

CT-E8-2

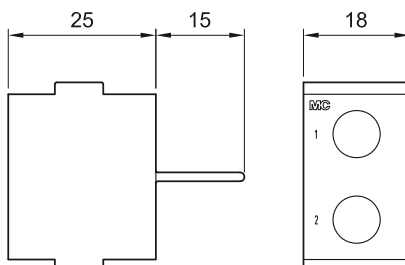

Order No.	Type
33.4000	CT-E8-2

Technical data	
Number of poles	2
For connectors	Coaxial
Pollution degree	2
Limiting temperature (IEC 61984:2008), upper	+90 °C
lower	-40 °C
Contact carrier material	EPTR



Assembly instructions MA213-02

[www.staubli.com/electrical](http://www.staubli.com/electrical)

# Coaxial connectors

For contact carrier CT-E8-2. Consist of parts of BNC plug connectors. For coaxial cables type RG58<sup>1)</sup> and RG59<sup>1)</sup>.

### Type of termination:

Crimp termination (C) of the inner conductor and the shield

### Notes:

For the termination of the shield, a brass crimping sleeve is included. The coaxial plug connectors are designed in accordance with CECC 22 120.

CT-B/COAX58



CT-S/COAX58





CT-B/COAX59

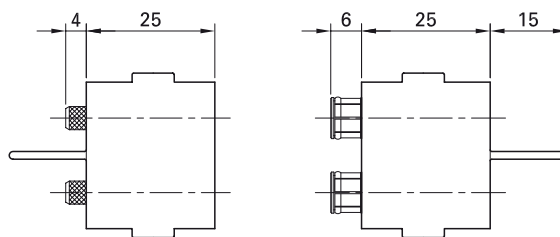

CT-S/COAX59

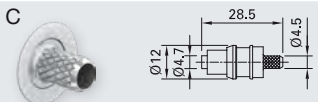
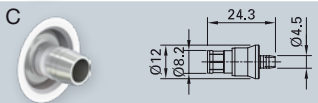
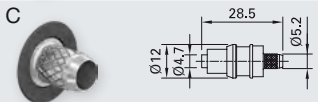
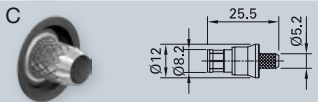

Order No.	Type	Socket	Pin	Inner-Ø crimp sleeve shield	Type of termination
33.0160	CT-B/COAX58	x		5.5 mm	C 
33.0560	CT-S/COAX58		x	5.5 mm	C 
33.0161	CT-B/COAX59 <sup>2)</sup>	x		6.5 mm	C 
33.0561	CT-S/COAX59 <sup>2)</sup>		x	6.5 mm	C 
33.4050	CT-BS8	Blind plug			

Technical data	
Average sliding force per contact	20 N
Surface inner conductor	CuZn, Au
Surface shield	CuZn, Ni
Voltage standing wave ratio	CT...58: VSWR ≤ 1.25 at f < 1.5 GHz CT...59: VSWR ≤ 1.5 at f < 500 MHz
Rated voltage shield/earth	1000 V, CAT II
Rated voltage inner conductor/shield	1000 V, CAT II
Impedance	CT...58: 50 Ω CT...59: 75 Ω
Voltage level according to	IEC 61010
Mating cycles, according to IEC 61984	5000
according to IEC 61169-8	2500

<sup>1)</sup> For the coaxial connectors CT-.../COAX58 and CT-.../COAX59, only the coaxial lead RG58 or RG59 is suitable.  
<sup>2)</sup> CT59: if a solid conductor is used, this must be soldered.

## 1 GBIT, 10 GBIT DATA TRANSFER UNIT

# 1 Gbit module CT-NET-...

Contact carrier made of plastic. One or two 8-pole pin or socket carriers with continuous shielding.

CT-NET-1/B



CT-NET-1/S

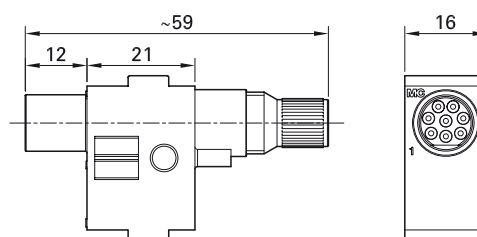

CT-NET-2/B



CT-NET-2/S

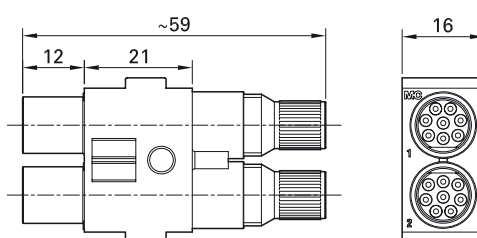

Order No.	Type	Number of contact elements
33.2240	CT-NET-2/B	Depending on contact arrangement on page 47; must be ordered separately
33.2540	CT-NET-2/S	
33.2241	CT-NET-1/B	
33.2641	CT-NET-1/S	

Technical data	
Data transmission	Ethernet up to 1 Gbit/s (Cat5e or higher) <sup>1)</sup> Protocols with lower data rates in some cases, depending on the cable type: Profibus, Profinet, Interbus, CAN-BUS, USB 2.0, PoE <sup>2)</sup>
Mating cycles	10,000
Limiting temperature (IEC 61984:2008), upper lower	+90 °C -40 °C
Contact carrier material insulation	PA PEEK



Assembly instructions MA213-04

[www.staubli.com/electrical](http://www.staubli.com/electrical)

<sup>1)</sup> Further technical specifications:  
<https://www.staubli.com/global/en/electrical-connectors/downloads/technical-info.html>

<sup>2)</sup> According to the IEC 60512-99-001 (100 mating cycles)



E229145

# Contacts for data transfer in BUS-System CT-NET-...

For contact carrier CT-NET-... Sockets fitted with MULTILAM.

**Type of termination:**  
Crimp termination (C) to a Cu conductor (class 5 and 6)

CT-NET-B...



CT-NET-S...

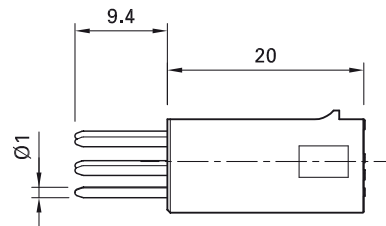
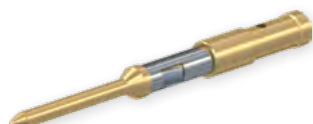

Order No.	Type	Socket	Pin	Surface	Conductor cross section		Rated current	Type of termination
					mm <sup>2</sup>	AWG		
33.0148	CT-NET-BP1 ET/0,14-0,75 AU	x			0.14	26	1	C 
33.0548	CT-NET-SP1/0,14-0,75 AU		x		0.25	24	2	
					0.34	22	3	
					0.5 <sup>1)</sup>	20	3	
	0.75 <sup>1)</sup>	18	5					
33.9589	CT-NET-BS <sup>2)</sup>	Blind plug						

### Technical data

Nominal-Ø socket/pin	Ø 1 mm
Average sliding force per connection (8 pins and shield)	10.5 N
Connector resistance	1.8 mΩ
Max. outer diameter per wire	2.3 mm
Maximum outer diameter over the whole cable with special nut CT-NET-MU.PFB; Order No. 13009834 and pliers CT-NET-Z-PFB; Order No. 13009832	7.5 mm 8.5 mm

### Contact arrangement of the contact carrier

Left: socket side; right: pin side  
(Viewed from the termination side)

#### CAT5

##### Ethernet/Profinet

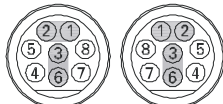

##### Interbus

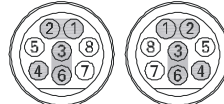

##### Profibus

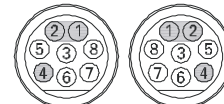

<sup>1)</sup> Maximal four wires per connector

<sup>2)</sup> Unused contact chambers should be closed with blind plugs.



Assembly instructions MA213-04

[www.staubli.com/electrical](http://www.staubli.com/electrical)

#### CAT5e

##### Ethernet/Profinet

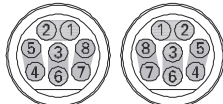

# 10 Gbit module CT-10GBIT-...

The 10 Gbit module is used for Ethernet communication up to 10 Gbit/s (CAT6A or higher).

Two versions are available, one for RJ45 and one for M12 (x-coded) connection.

The 10 Gbit module is delivered completely assembled.

- Suitable for RJ45 or M12 connection (same connections on both sides)
- UL 1977 and Railway standard compliant

- Resistance to shock (M12) and vibrations (M12, RJ45)
- Applications: high speed data communication, machine-to-machine communication (M2M), real time facility data sharing

## CT-10GBIT-RJ45/B



Rear view

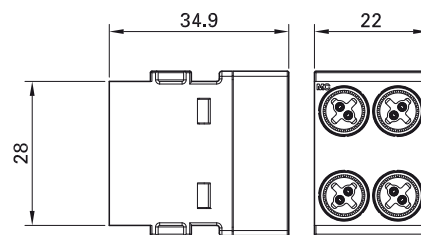
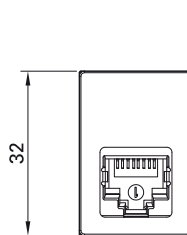

## CT-10GBIT-RJ45/S



Rear view

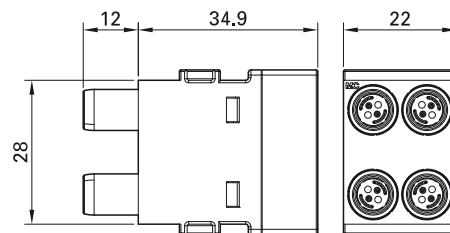
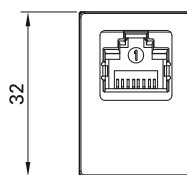

## CT-10GBIT-M12/B



Rear view

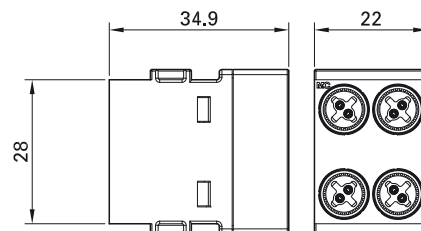
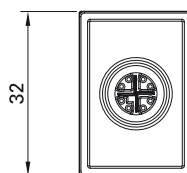

## CT-10GBIT-M12/S



Rear view

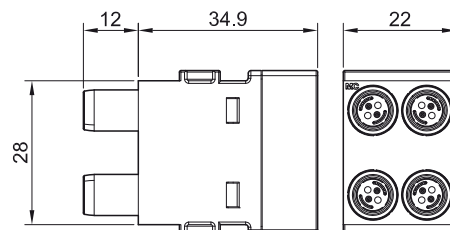
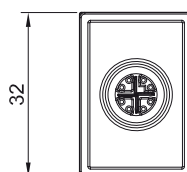

Order No.	Type
33.0130	CT-10GBIT-RJ45/B
33.0530	CT-10GBIT-RJ45/S
33.0240	CT-10GBIT-M12/B
33.0640	CT-10GBIT-M12/S

Technical data	
Data transmission	Ethernet up to 10 Gbit/s (Cat6a or higher) Protocols with lower data rates in some cases, depending on the cable type: Profibus, Profinet, Interbus, CAN-BUS, USB 2.0, PoE <sup>1)</sup> with M12
Mating cycles	100,000
Average sliding force per module	14 N
Rated current	0.75 A
Rated voltage <sup>2)</sup>	48 V
Limiting temperature (IEC 61984:2008), upper lower	+90 °C -40 °C
Contact carrier material	PA
Fire and smoke compliance	EN 45545-2 (HL3 R22 – R23)
Insulation resistance	≥ 500 MΩ
Vibrations, RJ45, M12	5 g/10 – 500 Hz (IEC 60512-6-4) 0.58 g/5 - 150 Hz (IEC 61373:2010 category 1B)
Resistance to shocks, M12	3.06 g/30 ms (IEC 61373:2010 category 1B)

**Note:**

For the M12 version, refer to the following drawings for cable length in housing (left) and panel mount (right).

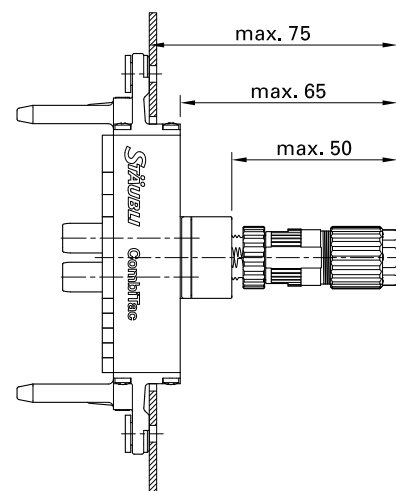
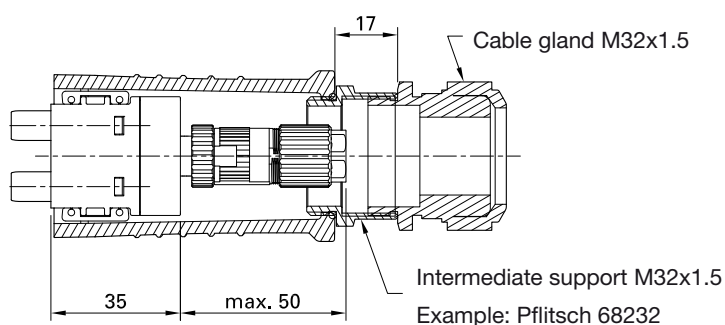

<sup>1)</sup> According to the IEC 60512-99-001 (100 mating cycles)  
<sup>2)</sup> Less than DC 30 V for UL 1977.



Assembly instructions MA213-08

www.staubli.com/electrical



E229145

# 1 Gbit module CT-RJ45/...

The module is used for Ethernet communication up to 1 Gbit/s (CAT 5e or higher).

Suitable network cables with a RJ45 connectors can be directly connected to the

module, which is delivered completely assembled.

## CT-RJ45/B



View from rear view

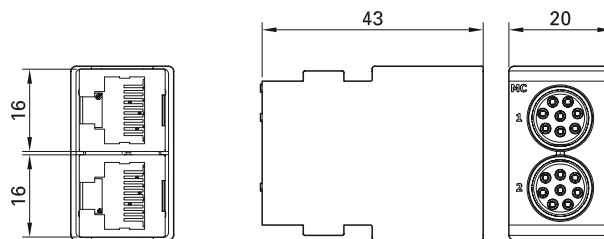

## CT-RJ45/S



View from rear view

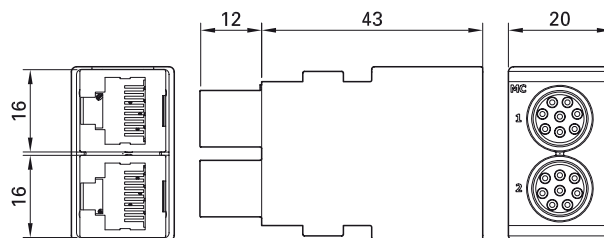

Order No.	Type
33.2169	CT-RJ45/B
33.2170	CT-RJ45/S

Technical data	
Data transmission	Ethernet up to 1 Gbit/s (Cat5e or higher) Protocols with lower data rates in some cases, depending on the cable type: Profibus, Profinet, Interbus, CAN-BUS, USB 2.0, PoE <sup>1)</sup>
Mating cycles	5000
Average sliding force per module (two connections)	19 N
Limiting temperature (IEC 61984:2008), upper lower	+90 °C -40 °C
Contact carrier material Insulation	PA PEEK
Test voltage 1 min., 50/60 Hz	U <sub>AC</sub> 500 V

<sup>1)</sup> According to the IEC 60512-99-001 (100 mating cycles)

Attenuation characteristics for CT-NET...

Attenuation characteristics for CT-RJ45...

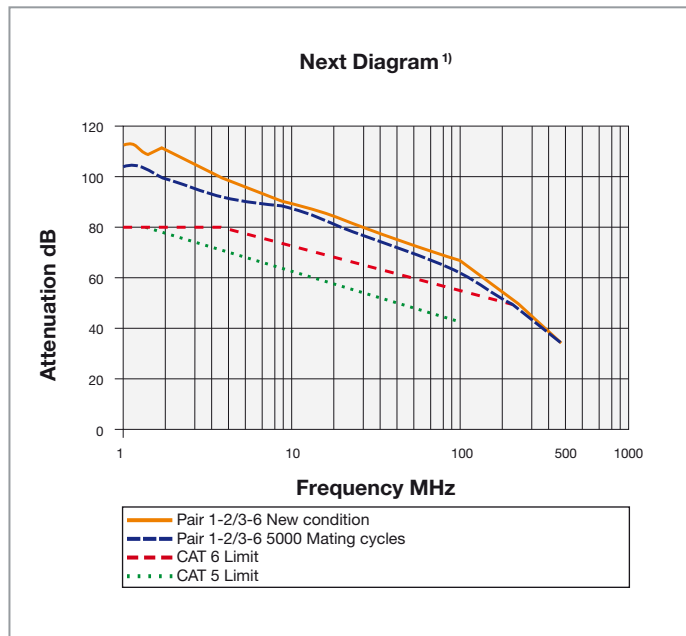
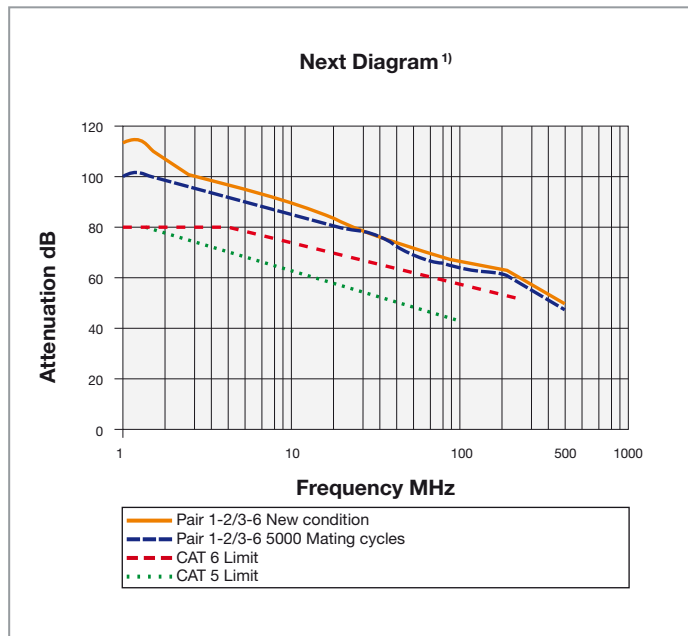

Attenuation characteristics for CT-10GBIT-...

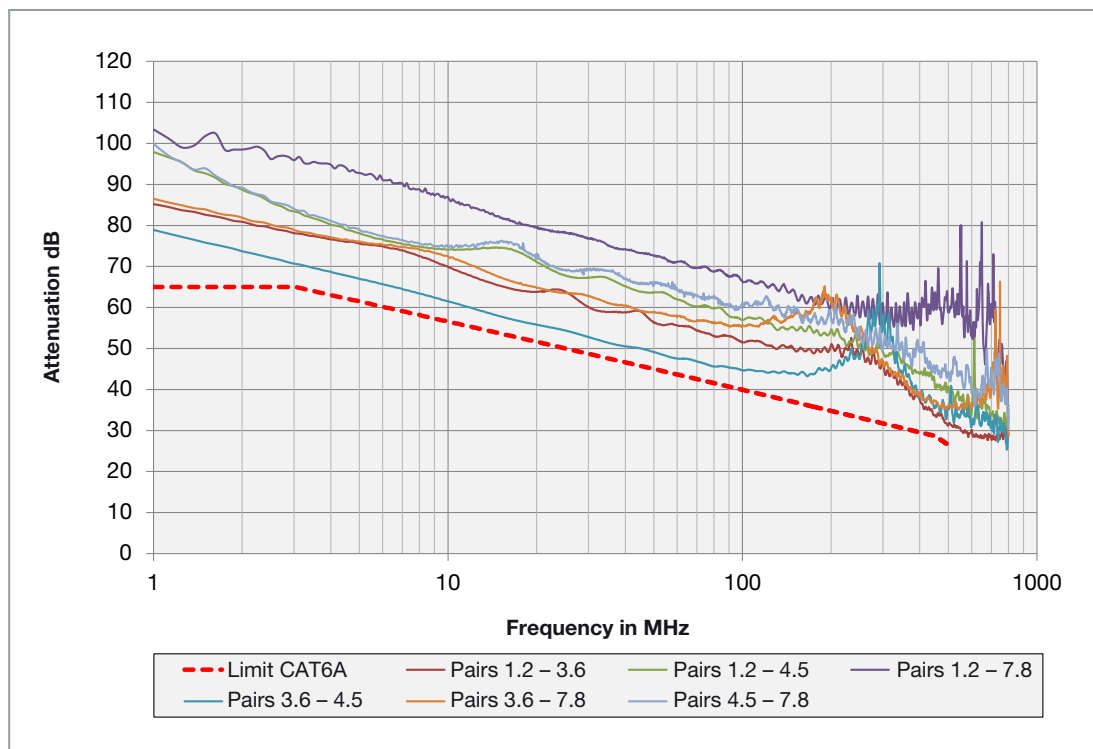

<sup>1)</sup> Further technical specifications:  
<https://www.staubli.com/global/en/electrical-connectors/downloads/technical-info.html>

OPTICAL FIBER UNIT POF

# Contact carriers CT-E-3POF/...

3-pole contact carrier made of plastic. Different designs for pins and sockets.

Because of the spring-loaded contacts, the contact carriers must be installed either in a

housing or with a locking system defined by the customer.

CT-E-3POF/B

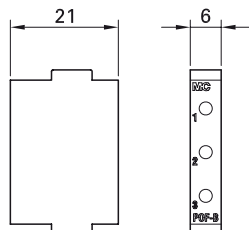

CT-E-3POF/S

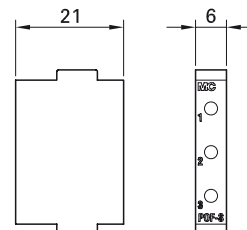

Order No.	Type	Description
33.4016	CT-E-3POF/B	Socket carrier (identification "B")
33.4017	CT-E-3POF/S	Pin carrier (identification "S")

Technical data	
Number of poles	3
For connector type	CT-B/POF, CT-S/POF
Limiting temperature (IEC 61984:2008), upper	+90 °C
lower	-40 °C <sup>1)</sup>
Contact carrier material	PA

# Contact carriers CT-E6-2

2-pole contact carrier in plastic for plastic optical fiber with lens, type CT-POF/SL.

CT-E6-2

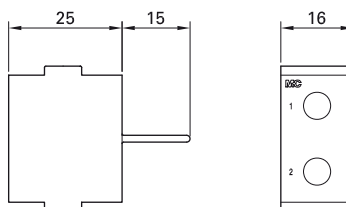

Order No.	Type
33.4006	CT-E6-2

Technical data	
Number of poles	2
For connector type	CT-POF/SL
Limiting temperature (IEC 61984:2008), upper	+90 °C
lower	-40 °C <sup>1)</sup>
Contact carrier material	EPTR

<sup>1)</sup> Check the temperature ratings of the optical fiber



Assembly instructions MA213-03

[www.staubli.com/electrical](http://www.staubli.com/electrical)

# Plastic optical fiber contacts CT-.../POF

For the connection of plastic optical fiber cables of the type POF Multimode. Standard version or lens version.

### Advantages of lens version CT-POF/SL:

- Higher tolerance against dirt
- Easy to clean
- Same type for both mating sides
- Higher number of mating cycles

### Note:

Cleaning the contact surface at regular intervals (depending on the environment) assure a constant attenuation value.

CT-B/POF



CT-S/POF



CT-POF/SL

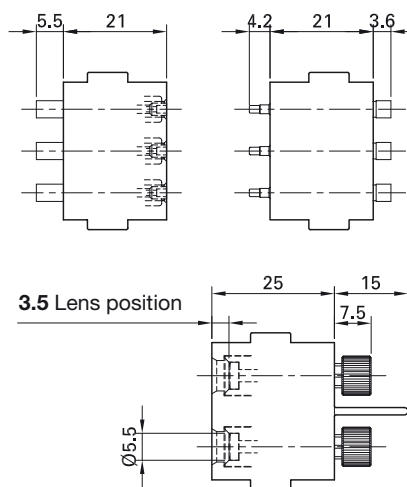

Order No.	Type	Socket	Pin	For contact carrier
33.0170	CT-B/POF	x		CT-E-3POF/B
33.0570	CT-S/POF		x	CT-E-3POF/S
33.0370	CT-POF/SL	x	x	CT-E6-2

Technical data	
Ø of core/cladding	980/1000 µm
Ø of first protective covering	2200 µm
Insertion loss CT-B/POF, CT-S/POF	< 3 dB at 650 nm, depending on assembly type
Insertion loss of the complete connector CT-POF/SL	< 6 dB at 650 nm
Mating cycles CT-POF	500
CT-POF/SL	100,000
Max. sliding force CT-POF	6 N
CT-POF/SL	0 N



Assembly instructions MA213-03

www.staubli.com/electrical

OPTICAL FIBER UNIT GOF

# Contact carrier CT-E-4GOF

4-pole contact carrier made of plastic.

CT-E-4GOF

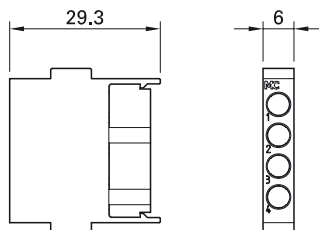

Order No.	Type
33.4065	CT-E-4GOF

Technical data	
Contact carrier material	PA

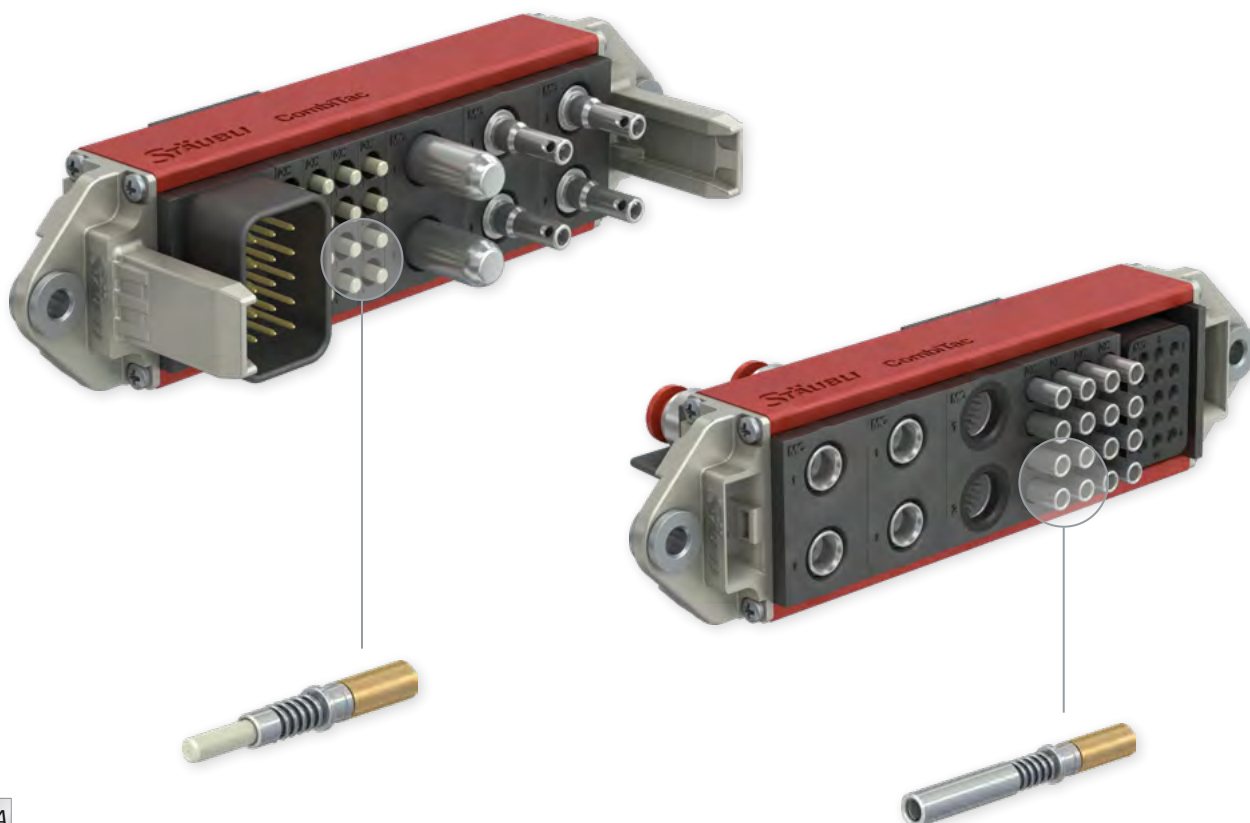

Assembly instructions MA213-06, MA092

[www.staubli.com/electrical](http://www.staubli.com/electrical)

# Glass optical fiber contacts CT-.../GOF

For the connection of glass optical fiber cables of the type Multimode to fit contact carrier CT-E-4GOF.

In preassembled cables, one end is equipped with ST, SC or FSMA plug connectors according to choice. The cable

length is 1 m or 0.3 m for FSMA pin. Fiber type: Graded-index multimode fiber OM2 50/125 µm. Cable diameter: 3 mm.

CT-B/GOF



CT-S/GOF



Socket side

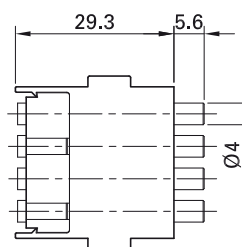

Pin side

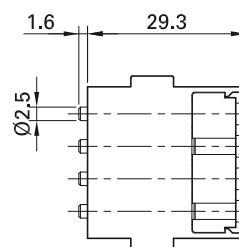

CT-B/GOF-100-ST

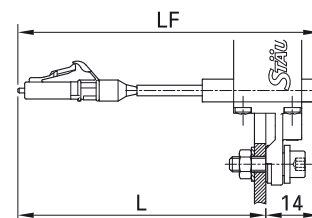
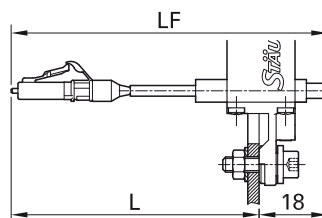

Order No.	Type	Socket	Pin	Designation	on tail end preassembled with
33.0171	CT-B/GOF	x		Contact for multimode fiber	
33.0571	CT-S/GOF		x	Contact for multimode fiber	
33.0171-100	CT-B/GOF-100-ST <sup>1)</sup>	x		1 m Preassembled multimode cable	ST
33.0571-100	CT-S/GOF-100-ST <sup>1)</sup>		x	1 m Preassembled multimode cable	ST
33.0172-100	CT-B/GOF-100-SC <sup>1)</sup>	x		1 m Preassembled multimode cable	SC
33.0572-100	CT-S/GOF-100-SC <sup>1)</sup>		x	1 m Preassembled multimode cable	SC
33.0228-100	CT-B/GOF-100-FSMA	x		1 m Preassembled multimode cable	FSMA
33.0628-030	CT-S/GOF-030-FSMA		x	0.3 m Preassembled multimode cable	FSMA
33.4080	CT-BSGOF	Blind plug			

### Technical data

Insertion loss (typical)	0.5 dB at 850/1300 nm, depending on assembly type
Mating cycles	≥ 500 (cleaning interval every 100 mating cycles) <sup>2)</sup>
Spring deflection	3 mm
Contact pressure	10 N per contact with 3 mm spring deflection
Allowable operating temperature IEC 60794-1-2 F1	-10 °C ... +70 °C for pre-assembled contacts

### Fiber types

Multimode fiber Ø of core/cladding	50/125 µm, 62.5/125 µm
Coating diameter	250/900 µm
Ø of cable	3 mm



Assembly instructions MA213-06, MA092

[www.staubli.com/electrical](http://www.staubli.com/electrical)

LF= total length.

L = length from CombiTac mounting position.

<sup>1)</sup> Other cable lengths and connectors type (LC, ...) on request. Specify L or LF length.

<sup>2)</sup> Note: Cleaning the contact surface at regular intervals (depending on the environment) assures a constant attenuation value and increases the number of mating cycles.

## THERMOCOUPLE UNIT

# Thermocouple pressure contacts

**Thermocouple allows for the precise measurement of temperatures. Between two wires of different materials a voltage is generated that varies according to the rise in temperature.**

The electrical measurement of temperature requires that the entire measurement chain (temperature sensor, cable connection points) consists of the same combination of materials. Using a uniform material pre-

vents thermal imbalances in the case of the connection of two parts with the same initial temperature.

With Stäubli thermocouple contacts, you can extend the measurement chains or lay them out as plug contact connections.

There are several types of thermocouples made from different materials adapted to the measured temperature range.

Stäubli thermocouple pressure contacts are available for 5 different types of sensor: E, J, K, N, and T. For that reason, Stäubli has developed different types of spring loaded contacts for thermocouples from the 7 most commonly used alloys: NiCr, NiAl, NiCrSi, NiSi, CuNi, Fe, Cu.

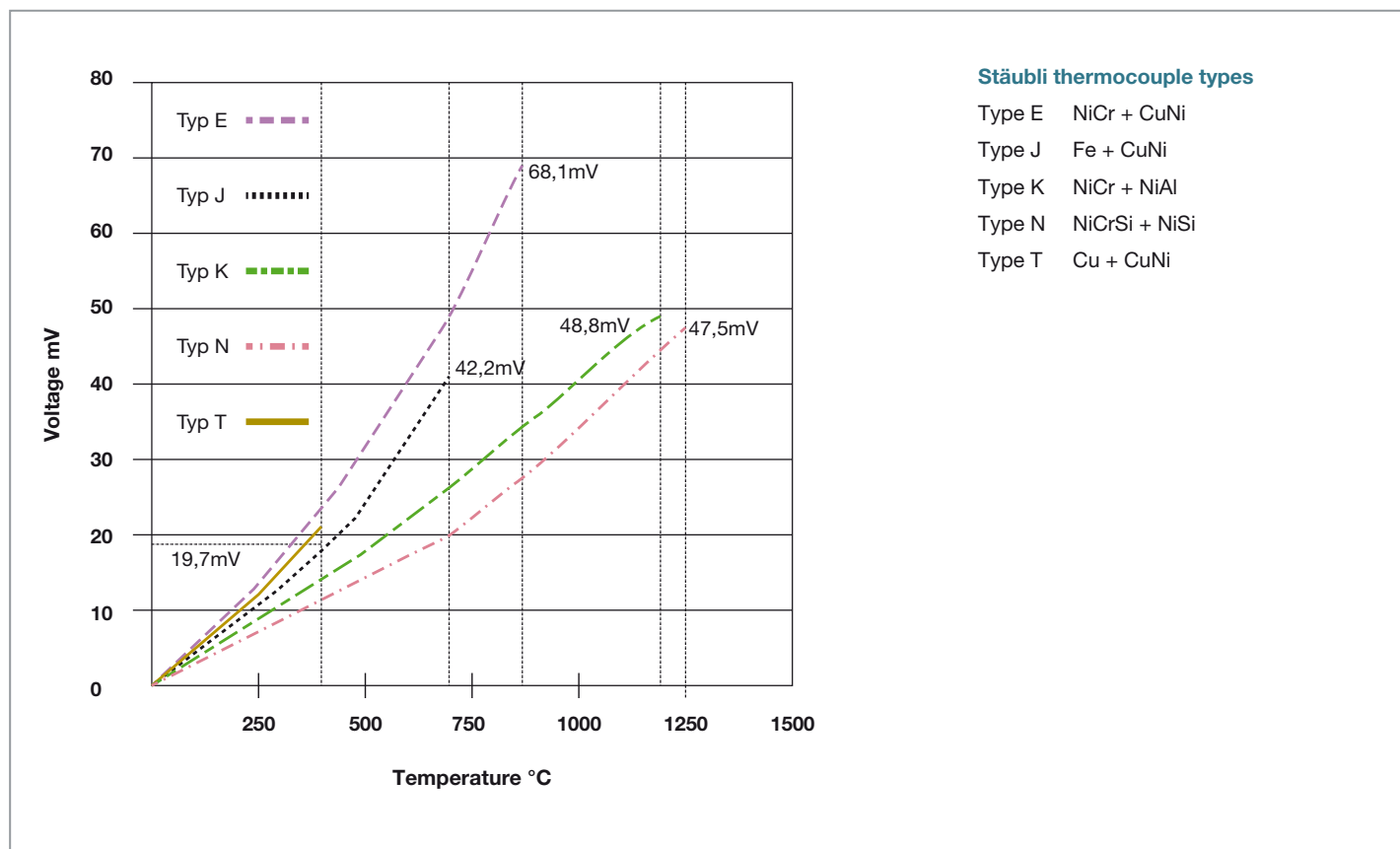

## Description according to: IEC 60584-1

To ensure clear identification, our spring-loaded thermocouple contacts are provided with different grooves and markings:

**Cu**  
Copper (without groove)



**Fe**  
Iron (without groove)



**NiAl**  
Alumel® (1 groove)



**NiCr**  
Chromel® (2 grooves)



**NiSi**  
Nisil (3 grooves)



**NiCrSi**  
Nicrosil (4 grooves)



**CuNi**  
Constantan® (1 wide groove)



Material marking

Groove

# Contact carrier CT-E-2TH+PE/...

3-pole contact carrier made of plastic. For two thermocouple pressure contacts and one PE contact.

Different designs for pins and sockets. Because of the spring-loaded contacts, the contact carriers must be installed either in

a housing or with a locking system defined by the customer.

**CT-E-2TH+PE/B**

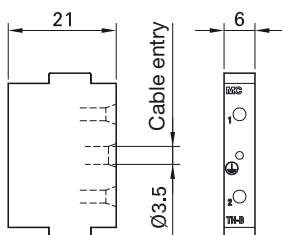

**CT-E-2TH+PE/S**

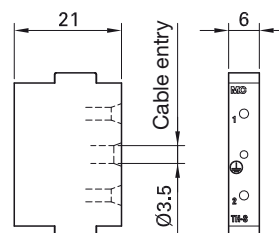

Order No.	Type	Description
33.4011	CT-E-2TH+PE/B	Socket carrier (identification "B")
33.4012	CT-E-2TH+PE/S	Pin carrier (identification "S")

### Technical data

Number of poles	1 thermocouple (2 contacts)/1 PE
Contact carrier material	EPTR



Assembly instructions MA213-01

[www.staubli.com/electrical](http://www.staubli.com/electrical)

# Thermocouple pressure contacts

For the connection of measurement chains for thermocouple, for contact carriers CT-E-2TH+PE/...

**Type of termination:**  
Crimp termination

**Note:**  
Soldering is not permitted, meaning that only uniform materials are used. **This ensures a homogeneous measurement chain.**



DBP2-...

DSP2-...

CT-BP1,5LAV/0,5-1,5 AU

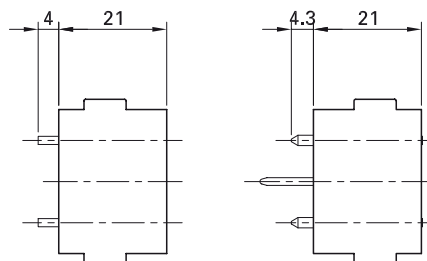
CT-SP1,5/0,5-1,5K AU

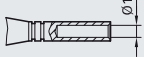
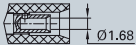

Order No.	Type	Socket	Pin	Material	Material marking	Groove marking	PE contact	Crimp termination	
19.6724	DBP2-NISI/0,14-0,5	x		NiSi	NIS				
19.6723	DSP2-NISI/0,14-0,5		x	NiSi	NIS				
19.6722	DBP2-NICRSI/0,14-0,5	x		NiCrSi	NIC				
19.6721	DSP2-NICRSI/0,14-0,5		x	NiCrSi	NIC				
19.6726	DBP2-CU/0,14-0,5	x		Cu	CU				
19.6725	DSP2-CU/0,14-0,5		x	Cu	CU				
19.6720	DBP2-FE/0,14-0,5	x		Fe	FE				
19.6719	DSP2-FE/0,14-0,5		x	Fe	FE				
19.6718	DBP2-CO/0,14-0,5	x		CuNi	CO				
19.6717	DSP2-CO/0,14-0,5		x	CuNi	CO				
18.8062	DBP2-AL/0,14-0,5	x		NiAl	AL				
18.9062	DSP2-AL/0,14-0,5		x	NiAl	AL				
18.8063	DBP2-CR/0,14-0,5	x		NiCr	CR				
18.9063	DSP2-CR/0,14-0,5		x	NiCr	CR				
33.0153	CT-BP1,5LAV/0,5-1,5 AU	x		CuZn, Au			x		
33.0550	CT-SP1,5/0,5-1,5K AU		x	CuZn, Au			x		
18.5504	MVS1	Blind plug							

## Technical data

For conductor cross section	0.14 mm <sup>2</sup> – 0.5 mm <sup>2</sup> <sup>1)</sup>
Contact pressure (spring insertion 1 mm)	6 – 9 N
Mating cycles	100,000 <sup>2)</sup>



Assembly instructions MA213-01

[www.staubli.com/electrical](http://www.staubli.com/electrical)

<sup>1)</sup> Contacts for conductor cross section 0.5 mm<sup>2</sup> – 1 mm<sup>2</sup> on request.

<sup>2)</sup> Maintenance interval: every 10,000 or 50,000 cycles depending on thermocouple type, see MA213.

## PNEUMATIC UNIT

# Compressed air and vacuum modules

## General information concerning compressed air

### Maximum working pressure

The maximum permitted pressure in a tubework component is the effective maximum pressure to which the component in question can be subjected in a given installation. The pressure is stated in bar or Pa (1 bar = 100 kPa).

### Upstream pressure

Pressure of the compressed air at the inlet to the socket/plug pair.

### Downstream pressure

Pressure at the outlet.

### Pressure drop

Pressure difference between the upstream and downstream pressure.

### Colored press rings for simple assignment

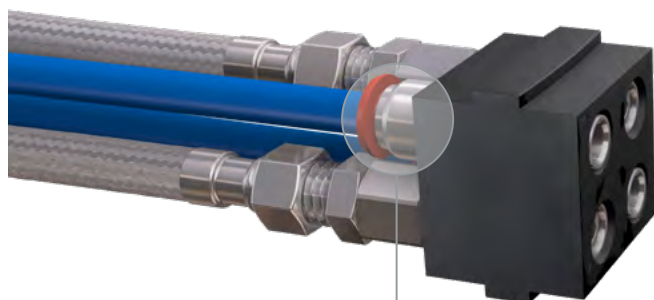

- Metric termination without shut-off
- Metric termination with shut-off
- Inch termination without shut-off
- Inch termination with shut-off

### Recommended calibrated plastic tubes:

TUBANE Stäubli (PU) / RILFLEX Stäubli (PA)

See catalog "Flexible hoses" from Stäubli

[www.staubli.com/content/dam/fcs/brochures/products/hoses/Hoses-for-all-fluids-staubli-en.pdf](http://www.staubli.com/content/dam/fcs/brochures/products/hoses/Hoses-for-all-fluids-staubli-en.pdf)

## Compressed air modules RCT... and UCT

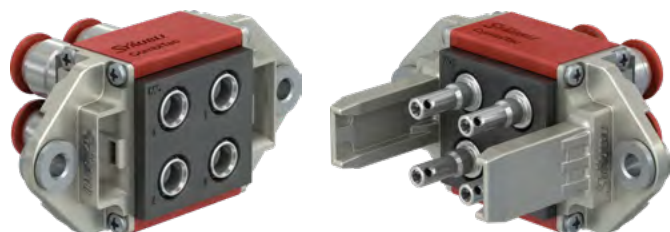

### RCT 03:

- Nominal bore: 3 mm
- With shut-off on one side or without shut-off valve

### RCT 06:

- Nominal bore: 6 mm
- With shut-off on one side or without shut-off valve



### UCT:

- Nominal bores: 4 mm, 6 mm, and 8 mm
- Without shut-off valve

The pneumatic units are supplied ready mounted in the carrier and cannot be removed.

Fluid couplings (pages 70 – 77) can also be used for pneumatic applications, if a shut-off valve on both sides is needed.

For further information please see pneumatic flow/pressure drop diagrams and sliding forces on pages 68 – 69.

# Carriers for pneumatic couplings CT-E8...

2- and 4-pole carriers made of resilient plastic.

**Note:**  
The contact carrier CT-E8-2 can be used on both the socket and the pin side.

**CT-E8-2**

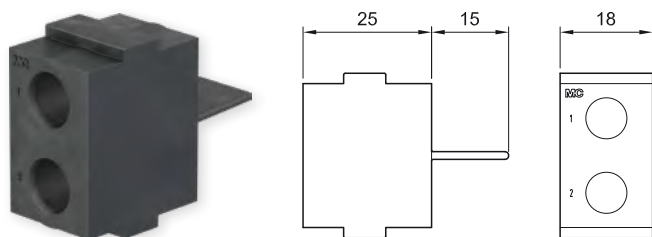

**CT-E8-4/B**

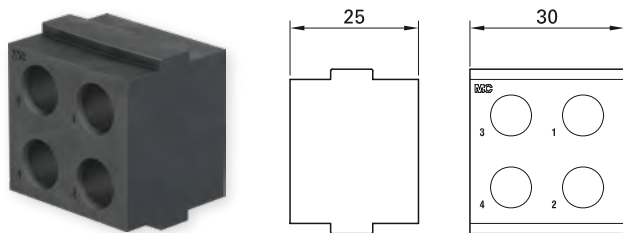

**CT-E8-4/S**

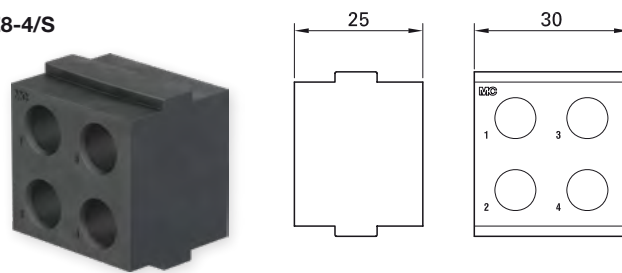

Order No.	Type	Number of poles	For sockets	For plugs
33.4000	CT-E8-2	2	×	×
33.4024	CT-E8-4/B	4	×	
33.4027	CT-E8-4/S	4		×

## Technical data

Contact carrier material      EPTR

Technical data from page 63:

## Technical data

	RCT03	UCT04
Nominal bore (mm)	03	04
Max. working pressure (bar)	15	
Min. working pressure (mbar)	14	
Operating temperatures	-15 °C ... +90 °C	
Sealing materials	NBR	
Mating cycles	100,000 <sup>2)</sup>	

# Pneumatic couplings CT-...-RCT03/... and CT-...-UCT04/...

For carriers CT-E8...

**Type of termination:**

Clamping and PLV screw connection for calibrated plastic tubes (PA or PU)

CT-B...-RCT03/...



CT-S...-RCT03/...



CT-B-UCT04/...



CT-S-UCT04/...



CT-BV-RCT03/PLV...



CT-S-RCT03/PLV...

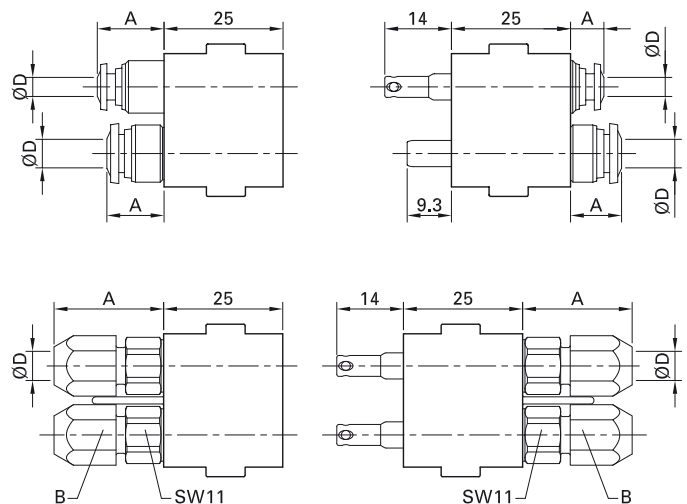

Order No.	Type	Socket	Plug	Outer-Ø D of the tube		A	B (SW)	Shut-off		Press ring color
				mm	"			Without	With	
33.0180	CT-B-RCT03/4	x		4	(5/32)	14		x		●
33.0181	CT-BV-RCT03/4	x		4	(5/32)	14			x	●
33.0580	CT-S-RCT03/4		x	4	(5/32)	7		x		●
33.0182	CT-B-RCT03/6 <sup>1)</sup>	x		6		17		x		●
33.0183	CT-BV-RCT03/6 <sup>1)</sup>	x		6		17			x	●
33.0582	CT-S-RCT03/6 <sup>1)</sup>		x	6		11.5		x		●
33.0184	CT-B-RCT03/1/4"	x			1/4	17		x		●
33.0185	CT-BV-RCT03/1/4"	x			1/4	17			x	●
33.0584	CT-S-RCT03/1/4"		x		1/4	11.5		x		●
33.0175	CT-B-RCT03/PLV4/6	x		6		23	11	x		
33.0179	CT-BV-RCT03/PLV4/6	x		6		23	11		x	
33.0578	CT-S-RCT03/PLV4/6		x	6		23	11	x		
33.0275	CT-B-RCT03/PLV 2/4	x		4		20	8	x		
33.0279	CT-BV-RCT03/PLV 2/4	x		4		20	8		x	
33.0675	CT-S-RCT03/PLV 2/4		x	4		20	8	x		
33.0186	CT-B-UCT04/6 <sup>1)</sup>	x		6		12		x		●
33.0586	CT-S-UCT04/6 <sup>1)</sup>		x	6		10.7		x		●
33.0188	CT-B-UCT04/1/4"	x			1/4	12		x		●
33.0588	CT-S-UCT04/1/4"		x		1/4	10.7		x		●

<sup>1)</sup> For flow/pressure drop diagrams, and sliding forces, see pages 68 – 69.

<sup>2)</sup> Lubrication interval every 20,000 mating cycles, see MA213.

# Carriers for pneumatic couplings CT-E-UCT06-...

1-, 2-, or 4-pole carrier made of resilient plastic.

**Note:**

The contact carrier can be used on both the socket and the pin side. The difference shows in the position of the MC logo.

**CT-E-UCT06-1**



**Socket side**

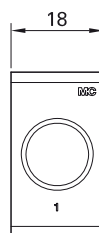

**Pin side**



**CT-E-UCT06-2**



**Socket side**

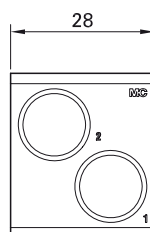

**Pin side**

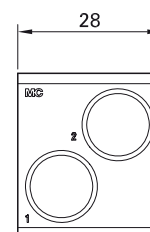

**CT-E-UCT06-4**



**Socket side**

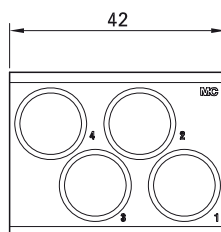

**Pin side**

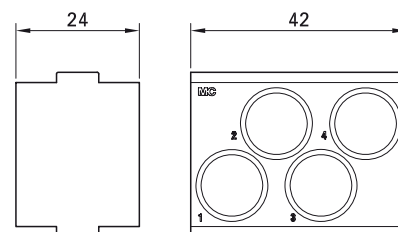

Order No.	Type	Number of poles	For sockets	For plugs
33.4028	CT-E-UCT06-1	1	x	x
33.4029	CT-E-UCT06-2	2	x	x
33.4030	CT-E-UCT06-4	4	x	x

**Technical data**

Contact carrier material | EPTR

# Pneumatic couplings CT-...-UCT06/8

For carriers CT-E-UCT06-...

**Type of termination:**

Clamping termination for calibrated plastic tubes (PA or PU)

CT-B-UCT06/8



CT-S-UCT06/8

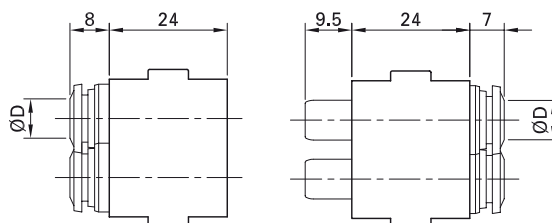

Order No.	Type	Socket	Plug	Outer-Ø D of the tube		Shut-off		Press ring color
				mm	"	Without	With	
33.0190	CT-B-UCT06/8 <sup>1)</sup>	x		8	(5/16)	x		
33.0590	CT-S-UCT06/8 <sup>1)</sup>		x	8	(5/16)	x		

Technical data	
Nominal bore (mm)	06
Max. working pressure (bar)	15
Min. working pressure (mbar)	14
Operating temperatures	-15 °C ... +90 °C
Sealing materials	NBR
Mating cycles	100,000 <sup>2)</sup>

<sup>1)</sup> For flow/pressure drop diagrams, and sliding forces, see pages 68 – 69.

<sup>2)</sup> Lubrication interval every 20,000 mating cycles, see MA213.

# Carriers for pneumatic couplings CT-E-UCT08-...

1- or 2-pole contact carrier made of resilient plastic.

**Note:**

The contact carrier can be used on both the socket and the pin side. The difference can be seen in the position of the MC logo.

**CT-E-UCT08-1**



**Socket side**

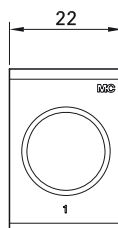

**Pin side**

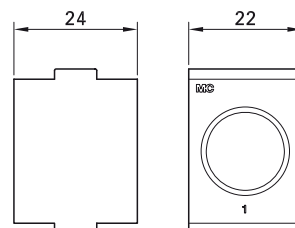

**CT-E-UCT08-2**



**Socket side**

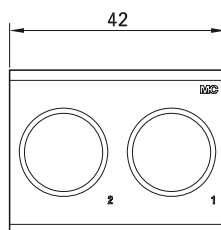

**Pin side**

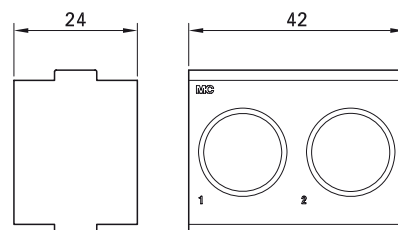

Order No.	Type	Number of poles	For sockets	For plugs
33.4032	CT-E-UCT08-1	1	x	x
33.4031	CT-E-UCT08-2	2	x	x

**Technical data**

Contact carrier material      EPTR

Technical data from page 67:

**Technical data**

	RCT06	UCT08
Nominal bore (mm)	06	08
Max. working pressure (bar)	15	
Min. working pressure (mbar)	14	
Operating temperatures	-15 °C ... +90 °C	
Sealing materials	NBR	
Mating cycles	100,000 <sup>1)</sup>	

<sup>1)</sup> Lubrication interval every 20,000 mating cycles, see MA213.

# Pneumatic couplings CT-...-UCT08... and CT-...-RCT06/...

For carriers CT-E-UCT08-...

**Type of termination:**

Clamping and PLV screw termination for calibrated plastic tubes (PA or PU)

**CT-BV-RCT06/8**



**CT-S-RCT06/8**

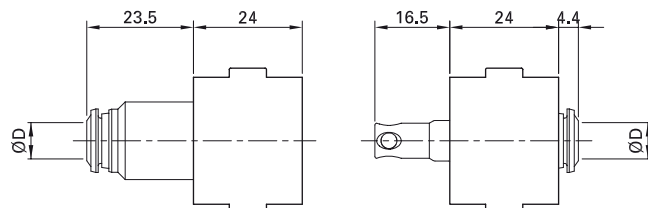

**CT-B-UCT08/10**



**CT-S-UCT08/10**

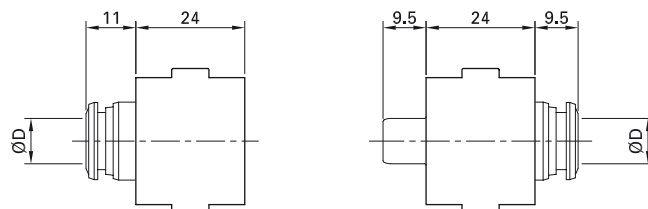

**CT-BV-RCT06/PLV6/8**



**CT-S-RCT06/PLV6/8**

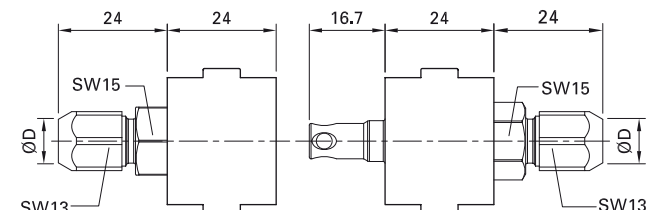

**CT-BV-RCT06/PLV8/10**



**CT-S-RCT06/PLV8/10**

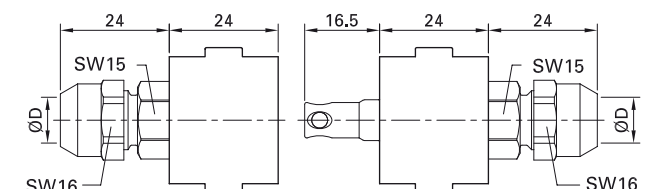

Order No.	Type	Socket	Plug	Outer-Ø D of the tube		A	Shut-off		Press ring color
				mm	"		without	with	
33.0201	CT-BV-RCT06/8	x		8	(5/16)		←	●	●
33.0601	CT-S-RCT06/8		x	8	(5/16)		x		●
33.0176	CT-BV-RCT06/PLV6/8	x		8				x	
33.0576	CT-S-RCT06/PLV6/8		x	8			x		
33.0177	CT-BV-RCT06/PLV8/10	x		10				x	
33.0577	CT-S-RCT06/PLV8/10		x	10			x		
33.0194	CT-B-UCT08/10 <sup>1)</sup>	x		10			x		●
33.0594	CT-S-UCT08/10 <sup>1)</sup>		x	10			x		●
33.0196	CT-B-UCT08/3/8"	x			3/8		x		●
33.0596	CT-S-UCT08/3/8"		x		3/8		x		●

<sup>1)</sup> For flow/pressure drop diagrams, and sliding forces, see pages 68 – 69.

# Pneumatic flow/pressure drop diagrams and sliding forces

## Pneumatic flow charts:

Under standard conditions 0 °C, 1013 mbar and specified input pressure

### CT-...-RCT03/6

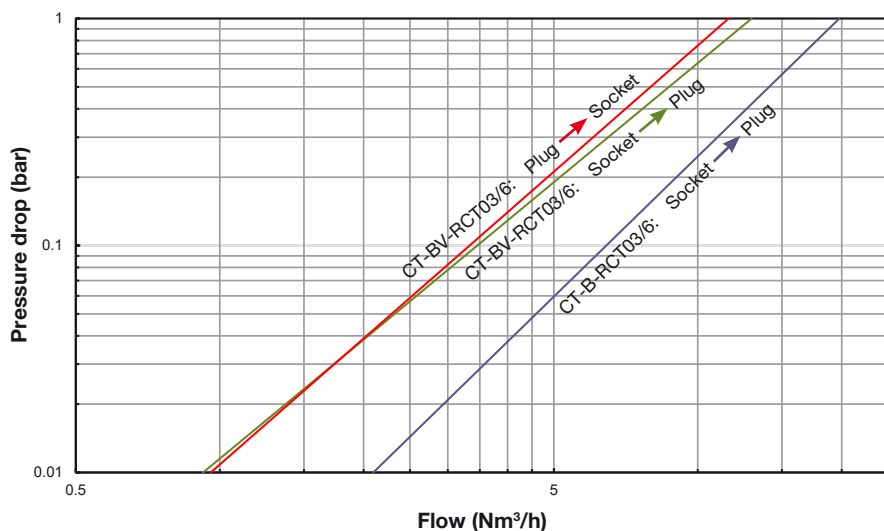

#### Flow direction:

CT-BV-RCT03/6 ← CT-S-RCT03/6

CT-BV-RCT03/6 → CT-S-RCT03/6

CT-B-RCT03/6 → CT-S-RCT03/6

	Max. sliding force		Input pressure
	0 bar	15 bar	
←	12 N	35 N	6 bar
→	10 N	33 N	6 bar

### CT-...-RCT06/8

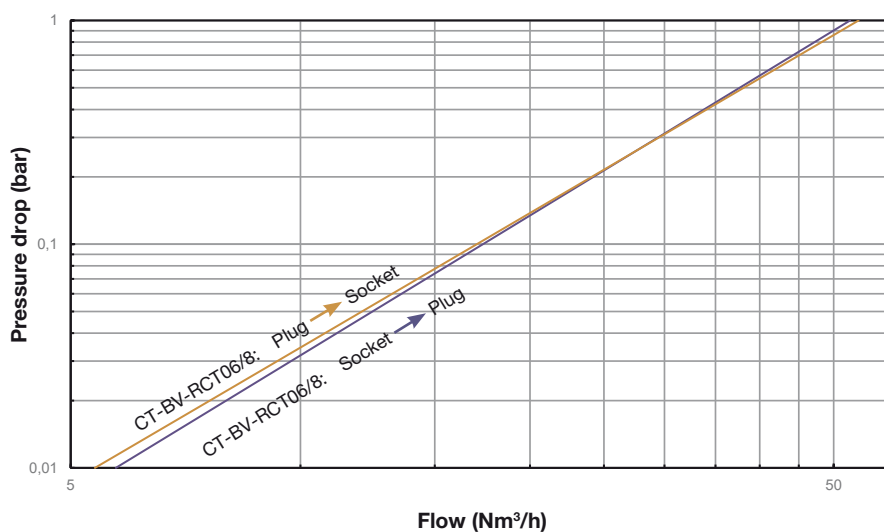

#### Flow direction:

CT-BV-RCT06/8 ← CT-S-RCT06/8

CT-BV-RCT06/8 → CT-S-RCT06/8

	Max. sliding force		Input pressure
	0 bar	15 bar	
←	19 N	106 N	6 bar
→			

### CT-...-UCT04/6 | CT-...-UCT06/8

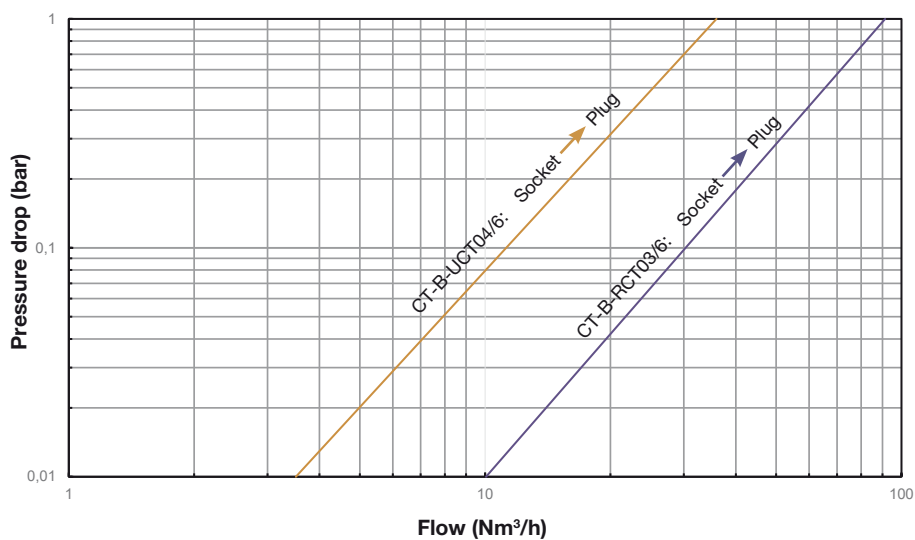

**Flow direction:**

- CT-B-UCT04/6 → CT-S-UCT04/6
- CT-B-UCT06/8 → CT-S-UCT06/8

	Max. sliding force		Input pressure
	0 bar	15 bar	bar
→ (Orange)	9 N	46 N	6
→ (Blue)	16,5 N	94 N	6

### CT-...-UCT08/10

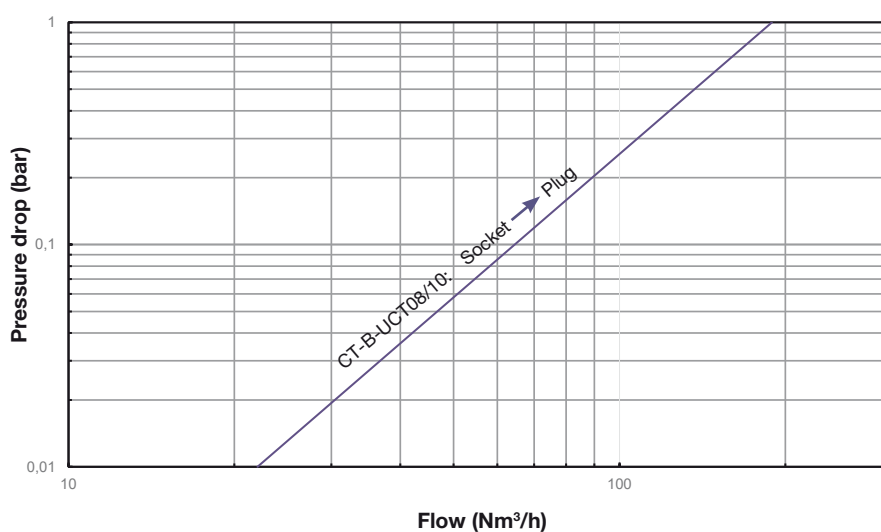

**Flow direction:**

- CT-B-UCT08/10 → CT-S-UCT08/10

	Max. sliding force		Input pressure
	0 bar	15 bar	bar
→ (Blue)	16 N	134 N	6

## FLUID UNIT

# Hydraulic modules

## General information concerning fluids

### Flow

The flow (l/min) is limited by the nominal bore and the flow rate (m/s).

A max. flow speed of 5 m/s is recommended. Otherwise, problems with seals or

non-laminar flow can occur. Slightly higher values can be accepted in individual cases.

### Pressure

Higher flow rate leads to higher pressure drop.

**Upstream pressure:** pressure P1 at the inlet to the socket/plug pair.

**Downstream pressure:** pressure P2 at the outlet.

The **flow direction** is non-symmetrical. Accordingly, the pressure drop depends on the flow direction. The standard direction is from the socket to the plug.

The pressure drop is independent of the operating pressure.

**Pressure drop:** pressure difference between the upstream and downstream pressure.

Typical pressure drop is 0.2 – 0.3 bar.

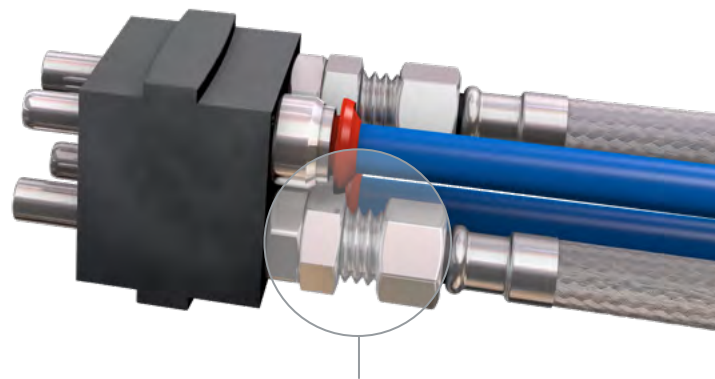
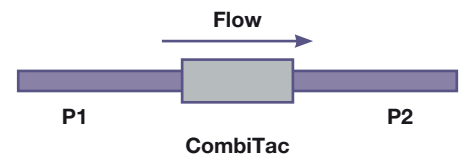

Brass, nickel plated

Fluid couplings can also be used for pneumatic applications, if a shut-off on both sides is needed.

Fluid units are supplied ready mounted in the carrier and cannot be removed.

For further information please see hydraulic- and pneumatic flow/pressure drop diagrams and sliding forces on pages 68 – 69.

See catalog “Flexible hoses” from Stäubli

[www.staubli.com/content/dam/fcs/brochures/products/hoses/Hoses-for-all-fluids-staubli-en.pdf](http://www.staubli.com/content/dam/fcs/brochures/products/hoses/Hoses-for-all-fluids-staubli-en.pdf)



**For SCT and LCT:**

- Nominal bores: 3 mm and 6 mm with shut-off on both sides
- Leakproof rapid couplings optional stainless steel version

- Suitable for panel mount and housing applications

Hydraulic flow	SCT03	LCT06
Hydraulic flow in l/min at flow speed of 5 m/s (max. recommended speed)	2.12	8.48

**Special products with these specifications on request:**

- The EPDM elastomer used for seals meets the inertia criteria of the US regulation FDA CFR 21.177.2600
- The lubricant G11 used complies with NSF – H1 requirements.
- Materials in contact with the transported fluid are made of stainless steel.

- The EPDM elastomer used for making seals in contact with the fluid meets the requirements of Class VI – 70 °C of in vivo tests (§<88>) according to USP34, National Formulary 29, 2011. It is considered non-cytotoxic (grade 0) for in vitro tests (§<87>) according to ISO 10993-5:2009 and USP34-NF29, 2011.

These specifications are only valid for the contacts (socket and plug), but not for the other parts of the CombiTac connector.

**Certificate**

- 3.1 on request

**Sealings**

Several sealing options are available in addition to the standard Nitrile (NBR) seal. The

seal material selected depends on the fluid carried.

Please do not hesitate to contact our technicians for advice.

Sealing material	Code	Applications
Nitrile (NBR)	NBR (standard)	<ul style="list-style-type: none"> <li>• General applications</li> <li>• High mechanical strength</li> </ul>
Fluorocarbon (FPM)	JV	<ul style="list-style-type: none"> <li>• Good chemical resistance</li> <li>• Resistance to mineral oils, synthetic hydraulic oils, fuels, chemicals, hydrocarbons and coolants</li> </ul>
Ethylene-propylene (EPDM)	JE	<ul style="list-style-type: none"> <li>• Compatible with phosphate – based brake fluids – esters, hot and cold water, steam</li> </ul>
Perfluoroelastomer (FFKM)	JK	<ul style="list-style-type: none"> <li>• Combines the qualities of an elastomer with the chemical resistance of PTFE</li> <li>• Resistance to most chemical agents</li> <li>• Coolants</li> </ul>
Fluorosilicone (FMQ)	JS3	<ul style="list-style-type: none"> <li>• Resistance to mineral oils, fuels</li> </ul>

# Carriers for fluid couplings CT-E8...

2- and 4-pole carrier made of resilient plastic.

**CT-E8-2**

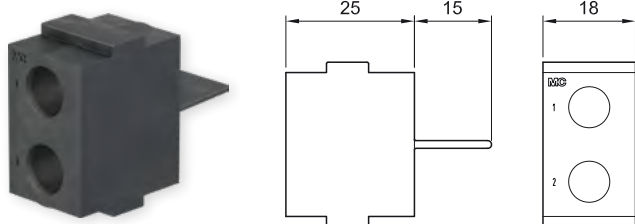

**CT-E-SCT03-2**

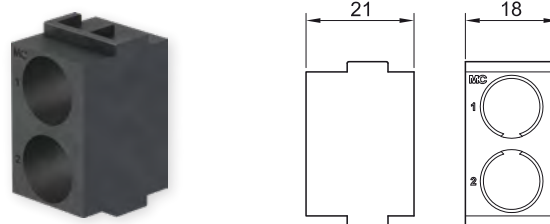

**CT-E8-4/B**

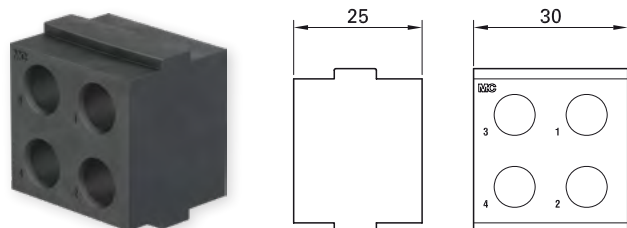

**CT-E8-4/S**

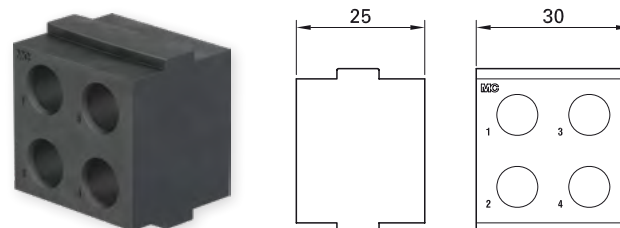

Order No.	Type	Number of poles	For sockets	For plugs
33.4000	CT-E8-2	2	×	×
33.4024	CT-E8-4/B	4	×	
33.4027	CT-E8-4/S	4		×
33.4077	CT-E-SCT03-2 <sup>1)</sup>	2	×	×

## Technical data

Contact carrier material, EPTR PA	33.4000, 33.4024, 33.4027 33.4077
--------------------------------------	--------------------------------------

<sup>1)</sup> Improved oil resistance

# Fluid couplings CT-...-SCT03

For carriers CT-E8..., leakproof, shut-off on both sides

**Type of termination:**  
Internal thread<sup>1)</sup>

CT-B-SCT03



CT-S-SCT03

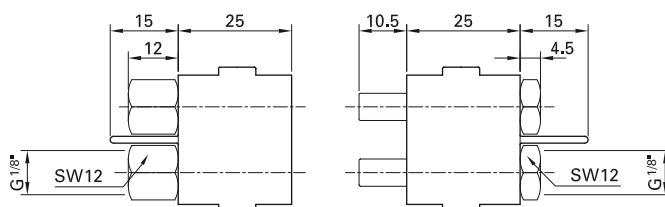

					Shut-off
Order No.	Type	Socket	Plug	Outer-Ø D of the tube	Leakproof
				"	
33.0198	CT-B-SCT03 <sup>2)</sup>	x		G1/8	x
33.0598	CT-S-SCT03 <sup>2)</sup>		x	G1/8	x

Technical data	
Nominal bore (mm)	03
Max. working pressure (bar)	15
Min. working pressure (mbar)	14
Spring force (permanent)	43 N without pressure
Operating temperatures	-15 °C ... +90 °C
Sealing materials	NBR
Mating cycles	100,000 <sup>3)</sup>

**Note**

Observe page 137 :  
Electrical plug connectors for control and power in the immediate proximity of connections for liquids and gas.

<sup>1)</sup> Recommended a torque of 15 N m, cylindrical thread and O-Ring seal  
<sup>2)</sup> For flow/pressure drop diagrams, and sliding forces, see pages 76 – 77.  
<sup>3)</sup> Lubrication interval every 20,000 mating cycles, see MA213.

# Carriers for fluid couplings CT-E-UCT08-...

1- and 2-pole carriers made of resilient plastic.

**Note:**

The contact carrier can be used on both the socket and the pin side. The difference can be seen in the position of the MC logo.

**CT-E-UCT08-1**



**Socket side**

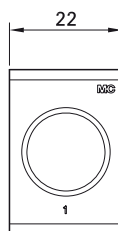

**Pin side**

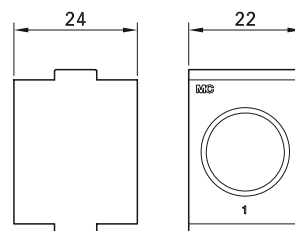

**CT-E-UCT08-2**



**Socket side**

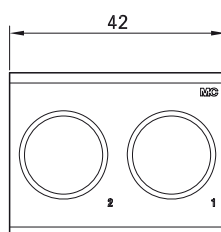

**Pin side**

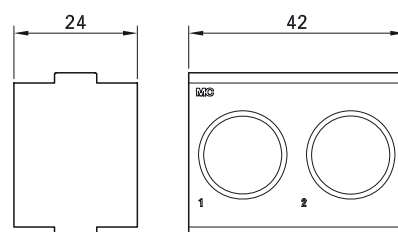

Order No.	Type	Number of poles	For sockets	For plugs
33.4032	CT-E-UCT08-1	1	×	×
33.4031	CT-E-UCT08-2	2	×	×

**Technical data**

Contact carrier material | EPTR

# Fluid couplings CT-...-LCT06

For carrier CT-E-UCT08-..., leakproof, shut-off on both sides

**Type of termination:**  
Internal thread

**Note:**

- CT-...-LCT06 suitable for panel and housing applications.

CT-B-LCT06



CT-S-LCT06

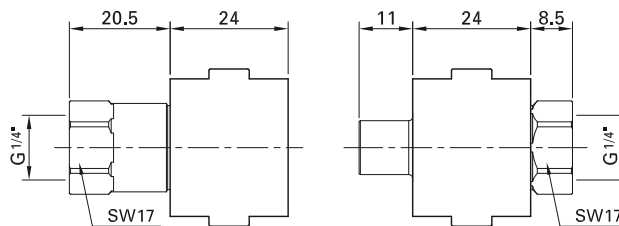

Order No.	Type	Socket	Plug	Outer-Ø D of the tube		A	Shut-off
				mm	"		With
33.0229	CT-B-LCT06 <sup>1)</sup>	x		8	G 1/4		x
33.0629	CT-S-LCT06 <sup>1)</sup>		x	8	G 1/4		x

Technical data	
Nominal bore (mm)	06
Max. working pressure (bar)	15
Min. vacuum absolute pressure (mbar)	14
Spring force (permanent)	44.5 N without pressure
Counter force while mated	135 N/10 bar; 187 N/15 bar
Operating temperatures	-15 °C ... +90 °C
Sealing materials	NBR
Mating cycles	100,000 <sup>2)</sup>

**Note**

Observe page 137 :  
Electrical plug connectors for control and power in the immediate proximity of connections for liquids and gas.

<sup>1)</sup> For flow/pressure drop diagrams, and sliding forces, see pages 76 – 77.

<sup>2)</sup> Lubrication interval every 20,000 mating cycles, see MA213.

# Hydraulic- and pneumatic flow/pressure drop diagrams

## Hydraulic flow charts:

Water (volumetric mass 998 kg/m<sup>3</sup>).

The hydraulic diagrams apply to a straight course of the tubes. If there are bends (e.g. in housings with a side entry), the pressure drop may increase.

## Pneumatic flow charts:

Under standard conditions 0 °C, 1013 mbar and specified input pressure.

## CT-...-SCT03 Hydraulic

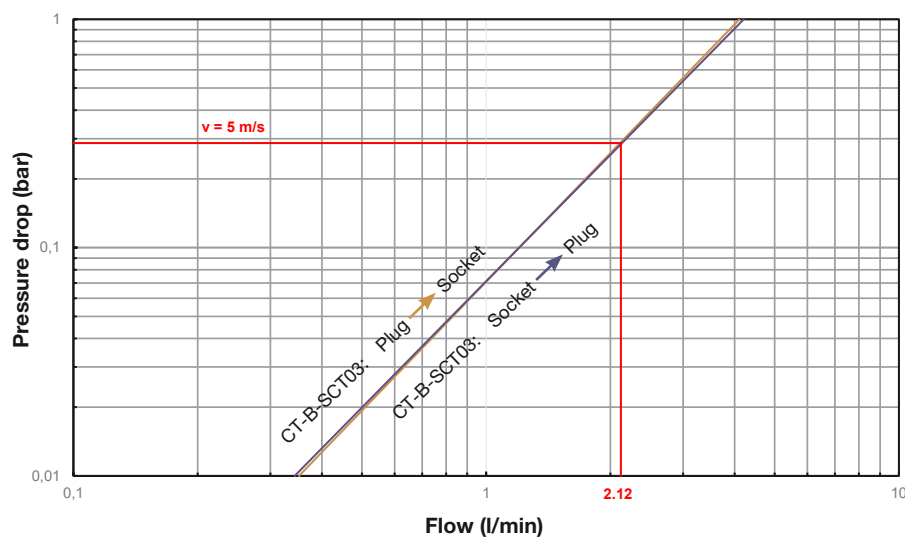

### Flow direction:

CT-B-SCT03 ← CT-S-SCT03  
 CT-B-SCT03 → CT-S-SCT03

	Viscosity
	cSt
←	1.08
→	1.08

## CT-...-SCT03 Pneumatic

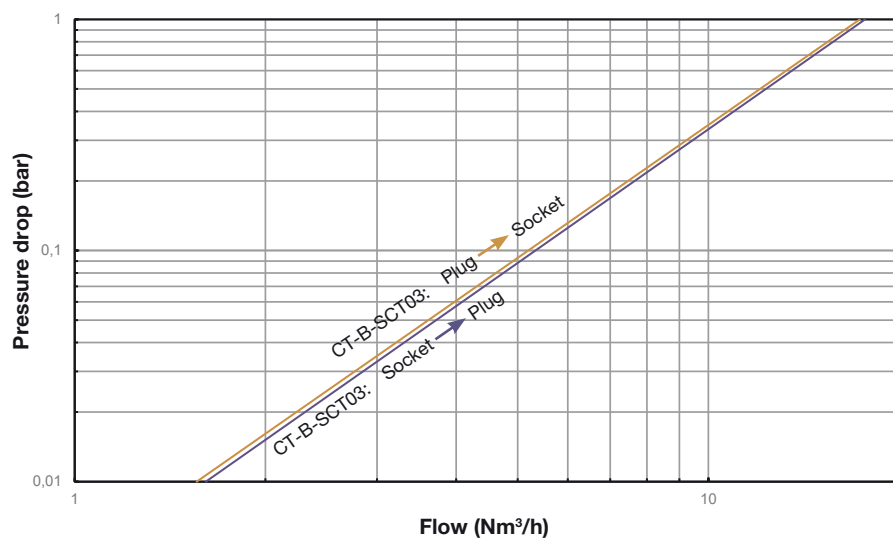

### Flow direction:

CT-B-SCT03 ← CT-S-SCT03  
 CT-B-SCT03 → CT-S-SCT03

	Input pressure
	bar
←	6
→	6

### CT-...-LCT06 Hydraulic

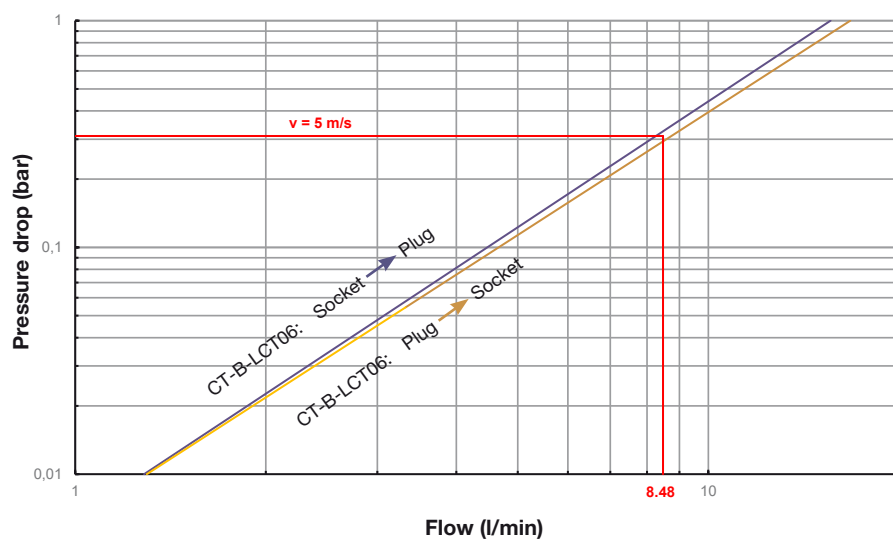

**Flow direction:**

- CT-B-LCT06 ← CT-S-LCT06
- CT-B-LCT06 → CT-S-LCT06

	Viscosity
	cSt
←	1.08
→	

### CT-...-LCT06 Pneumatic

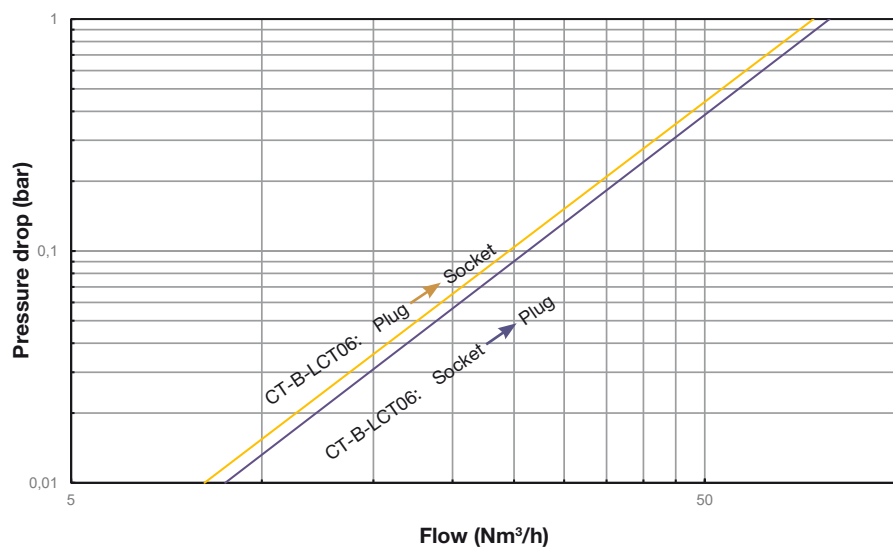

**Flow direction:**

- CT-B-LCT06 ← CT-S-LCT06
- CT-B-LCT06 → CT-S-LCT06

	Input pressure
	bar
←	6
→	

SPACERS

# Spacers

To fill gaps in the CombiTac or for connection coding.

CT-DIP...

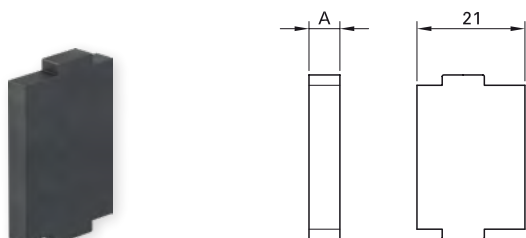

CT-DIP.../2

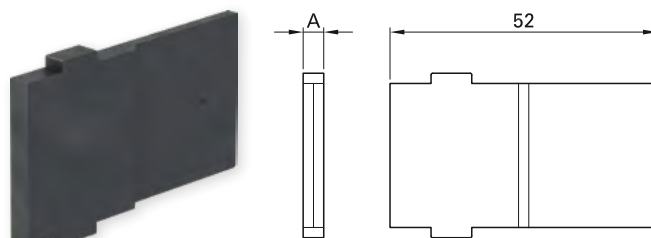

Order No.	Type	Size A
33.4097	CT-DIP0,5	0.5 mm
33.4043	CT-DIP1	1 mm
33.4063	CT-DIP1 K	1 mm
33.4040	CT-DIP2	2 mm
33.4770	CT-DIP2/2	2 mm
33.4041	CT-DIP3	3 mm
33.4042	CT-DIP4	4 mm
33.4085	CT-DIP4/2	4 mm

Technical data

	PA	EPTR
Contact carrier material	CT-DIP0,5; CT-DIP2/2; CT-DIP4/2	CT-DIP1; CT-DIP1 K; CT-DIP2; CT-DIP3; CT-DIP2
Limiting temperature (IEC 61984:2008), upper lower	+125 °C -40 °C	+90 °C -40 °C

Gaps filled with **spacers** in a CombiTac mounted in a DIN housing (pictures above). If the contacts are arranged symmetrically,

the possibility of pole reversal exists. With the help of spacers, a **connection coding** can be realized (pictures below).



Spacers

Connection coding

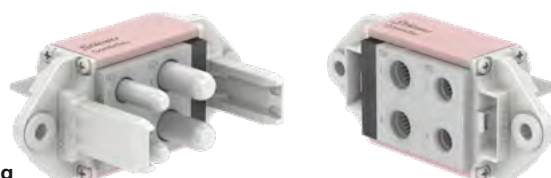

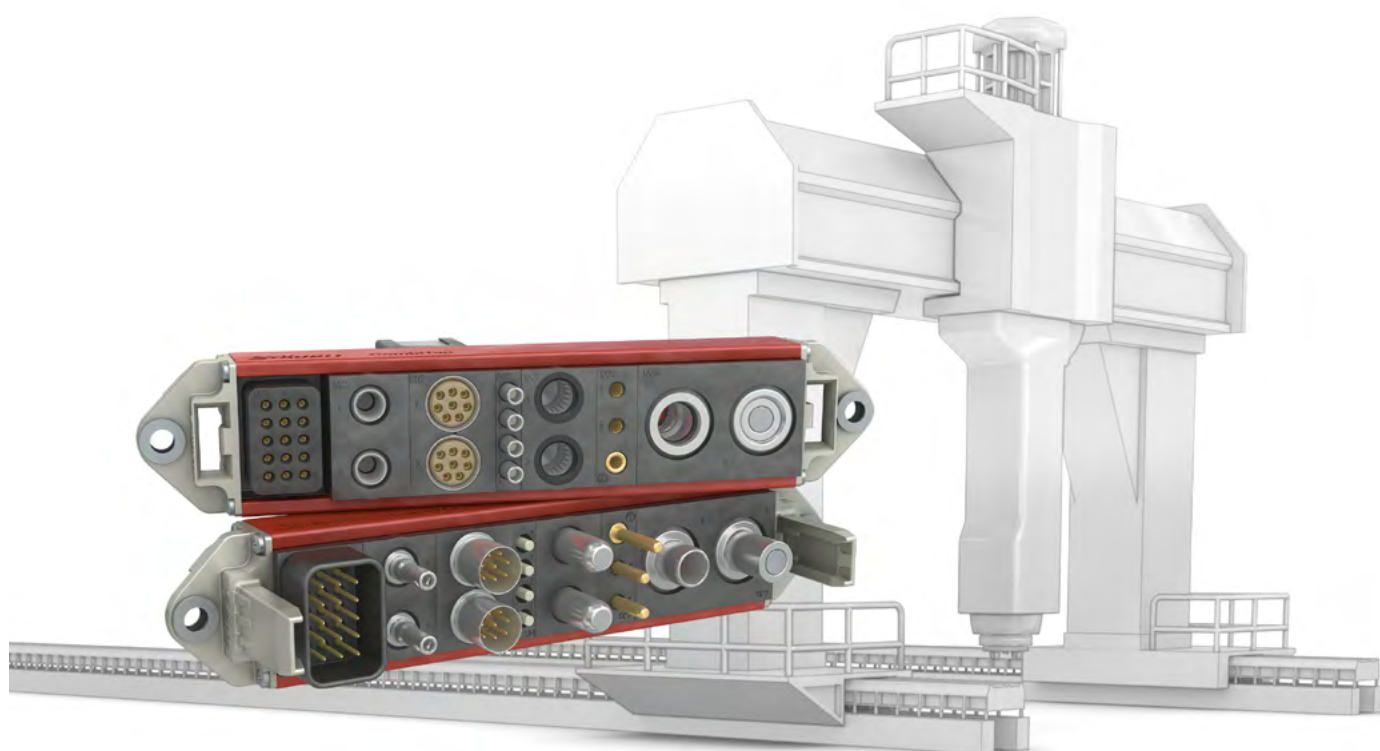

## COMBITAC ALIGN

# High misalignment solution for Ø 4 mm CT-HME-...

The CombiTac align 4 high misalignment solution provides radial and angular misalignment absorption during the connection process in docking applications. The pins on the male side serve as guiding pins, the female side has a conic shape. The guiding pins include insulation caps to prevent unintentional contact with live parts on the socket side.

### Features:

- Covers radial and angular misalignment up to 4 mm and  $\pm 2^\circ$  (vertical axis), respectively
- Up to 100,000 mating cycles
- Insulation security on the guiding pins to prevent unintentional contact with live parts on the socket side
- Suitable for all CombiTac uniq panel mount sizes

### Benefits:

- All-in-one solution
- Simplified guiding system
- Added user safety
- Long-life solution
- Cost- and space-saving with a ready-to-use solution

### Applications

There are various industries where CombiTac high misalignment end pieces are needed, such as small AGVs, logistics, robotics, e-mobility, automotive, aerospace and food industry. Typical applications are automated docking/connection for battery swapping of logistic indoor vehicles.

Also, many other industries require higher tolerance absorption for automatic connectors in e.g. production lines, testing applications, etc.



The end pieces are designed solely for the guiding of the connectors and the associated forces.

In a permanent installation application, the customer must provide a stable guide system,

e.g. with mechanical pins in addition to the CombiTac align 4 solution.

CT-HME-S/4

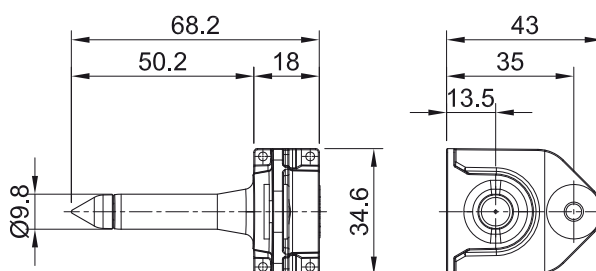

CT-HME-B/4

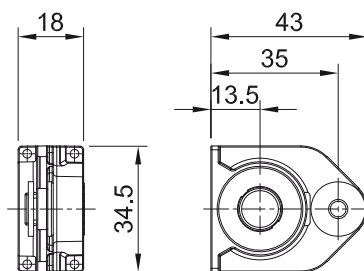

Order No.	Type	Description
33.0245	CT-HME-S/4	Male part for panel mount
33.0244	CT-HME-B/4	Female part for panel mount

Technical data	
Misalignment absorption, radial	4 mm
angular	±2° (vertical axis)
Mating cycles	100,000
Material	Zinc die casting
Ambient temperature for CT-HME-... <sup>1)</sup>	0 °C – 125 °C

<sup>1)</sup> Temperature rating of electrical contacts and carriers remains as specified in their relative specification section in catalog.

## SINGLE PARTS FOR COMBITAC FRAMES

# Single parts for CombiTac frames

**Note:**

Supporting rails are available in lengths from 18 mm up to 180 mm in steps of 2 mm (18, 20, 22, 24, etc.).

Exception: For housing size 2, a length of 43 mm is required. The length must be stated in mm together with the order No.

Mating cycles of end pieces: > 100,000

The end pieces are designed solely for the guiding of the connectors and the associated forces.

In a permanent installation application, the customer must provide a stable guide system, e.g. with mechanical pins.

**Hardstop:**

If the overall system does not have a defined stop, this special screw can be used to provide a hard stop (c) so that the force does not impact on the contacts during the mating process.



Pos.	Order No.	Type	Designation	Number per frame		Image
				Socket	Pin	
	33.5606-...	CT-BS	Supporting rail in plastic (PA) (length in mm)	2	2	
	33.5601-...	CT-BS-AL	Supporting rail in aluminum, on request (length in mm)	2	2	
	33.4056 33.5718	CT-BEG-B CT-BTG-B	Standard end piece for DIN housing, sockets Option without ground connection	2		
	33.4057 33.5719	CT-BEG-S CT-BTG-S	Standard end piece for DIN housing, pins Option without ground connection		2	
	33.4054 33.4058	CT-BE-B CT-BESZ-B	Standard end piece for panel mounting, sockets Option with ground connection	2		
	33.4055 33.4059	CT-BE-S CT-BESZ-S	Standard end piece for panel mounting, pins Option with ground connection		2	
a	33.2890	LI-SHR-GF	Torx screw M3x10 (for securing in the Stäubli DIN housing)	4	4	
b	33.5615	LI-BL-SHR	Filister head screw (for securing the end pieces)	8	8	
c	33.2015	CT-SHR-HS	Screw for end pieces for panel mount with hardstop	2	2	



Assembly instructions MA213

[www.staubli.com/electrical](http://www.staubli.com/electrical)

## CALCULATION OF INSTALLATION DIMENSIONS

# Calculation of installation dimensions

To determine the dimension L, the width of all contact carriers in the relevant configuration must be taken into account.

**Note:**

- If necessary, fill up with spacers (see page 78)

- General dimensional tolerances  $\pm 0.1$  mm
- L1 (recess dimensions) = L + 22 mm; L2 = L + 33 mm

Type	Number	Width	
CT-E12		x 30 mm	=
CT-E8/6-PE, CT-E6-2		x 16 mm	=
CT-E8-2, CT-E3-.../HV..., CT-E1-26		x 18 mm	=
CT-E3-3, CT-E3/PCB, CT-E3-2+PE		x 10 mm	=
CT-E1,5-4/HV		x 8 mm	=
CT-E1,5-5, CT-E-2TH+PE		x 6 mm	=
CT-E1-15		x 20 mm	=
CT-E1-6		x 4 mm	=
CT-E0,6-20		x 5.1 mm	=
CT-LMFB		x 6 mm	=
CT-E-COAX, CT-NET		x 16 mm	=
CT-10GBIT		x 22 mm	=
CT-RJ45		x 20 mm	=
CT-E-3POF, CT-E-4GOF		x 6 mm	=
CT-E8-4		x 30 mm	=
CT-E-UCT06-1		x 18 mm	=
CT-E-UCT06-2		x 28 mm	=
CT-E-UCT06-4, CT-E-UCT08-2		x 42 mm	=
CT-E-UCT08-1		x 22 mm	=
further moduls			
<b>Contact carriers</b>			
CT-DIP0,5		x 0.5 mm	=
CT-DIP1		x 1 mm	=
CT-DIP2		x 2 mm	=
CT-DIP3		x 3 mm	=
CT-DIP4, CT-DIP4/2		x 4 mm	=
further moduls			
<b>Spacers</b>			
Sum of the widths (min. 18 mm)		<b>L =</b>	

Socket side

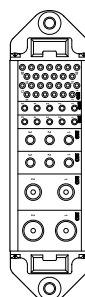

Pin side

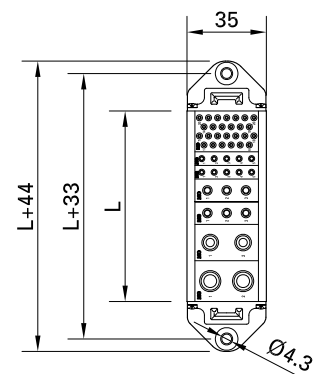

Socket side

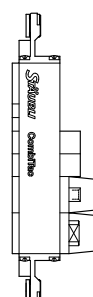

Pin side

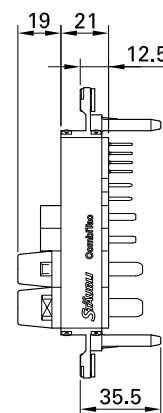

# Drilling plan

Panel mounting drilling plan for CombiTac with panel mount end pieces

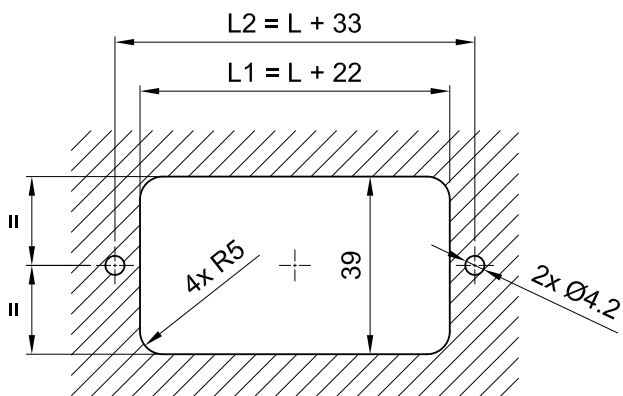

Panel mounting drilling plan for CombiTac with high misalignment end pieces

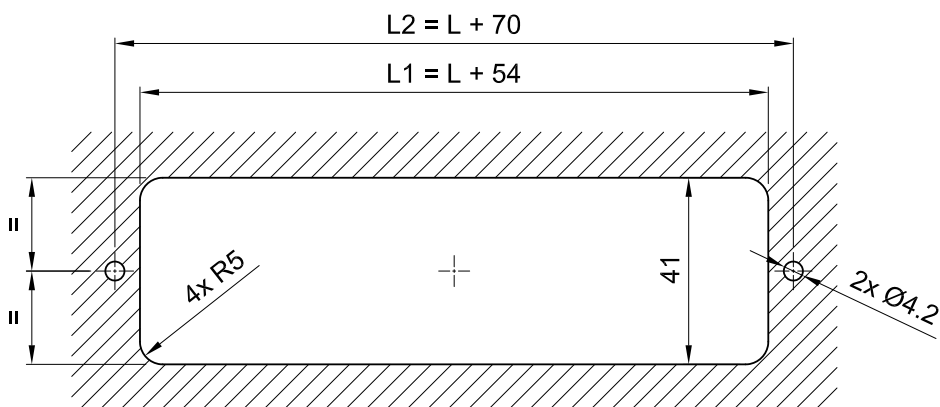

Pin side panel mounting drilling plan for CombiTac with housing end pieces

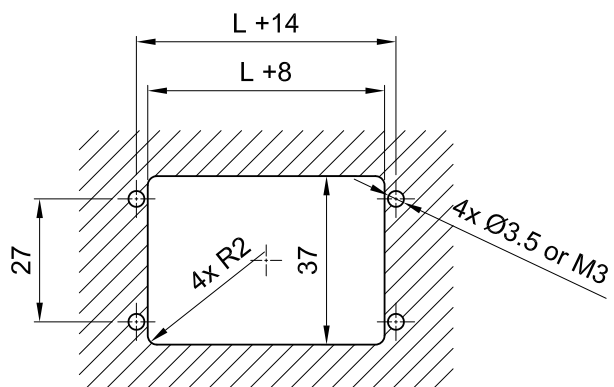

Socket side panel mounting drilling plan for CombiTac with housing end pieces

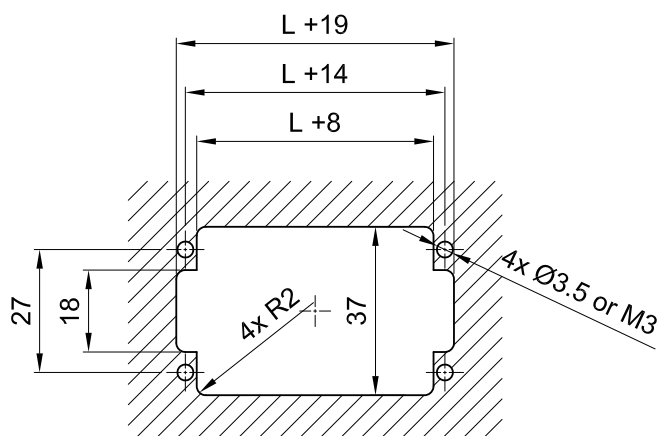

PANEL MOUNTED

# Panel mounted

## Max. permissible mounting offset

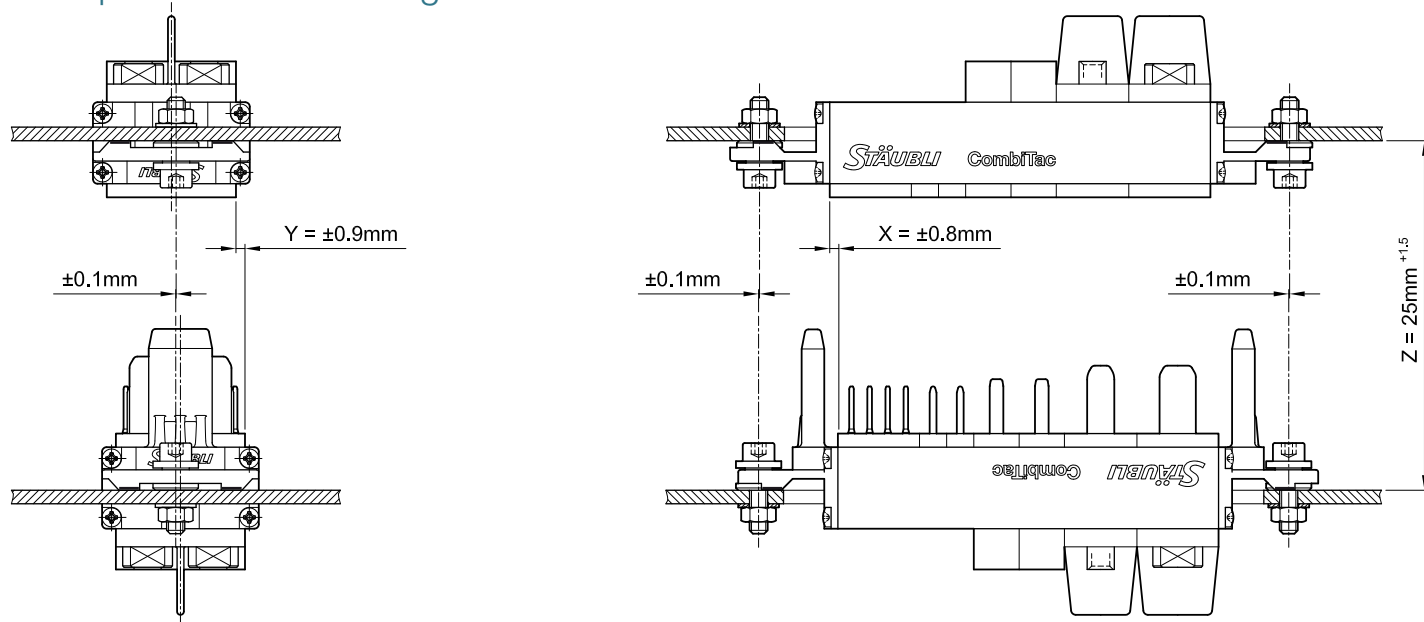

Distance Z in mated condition

## Max. permissible mounting angular misalignment/distance during mating

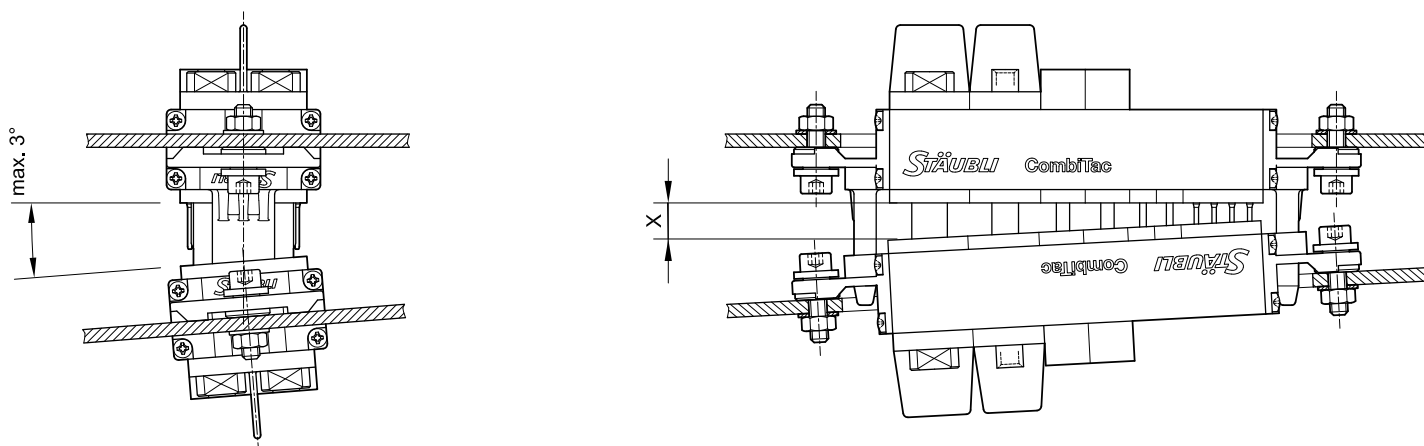

## Max. permissible distance between the contact carriers when mated

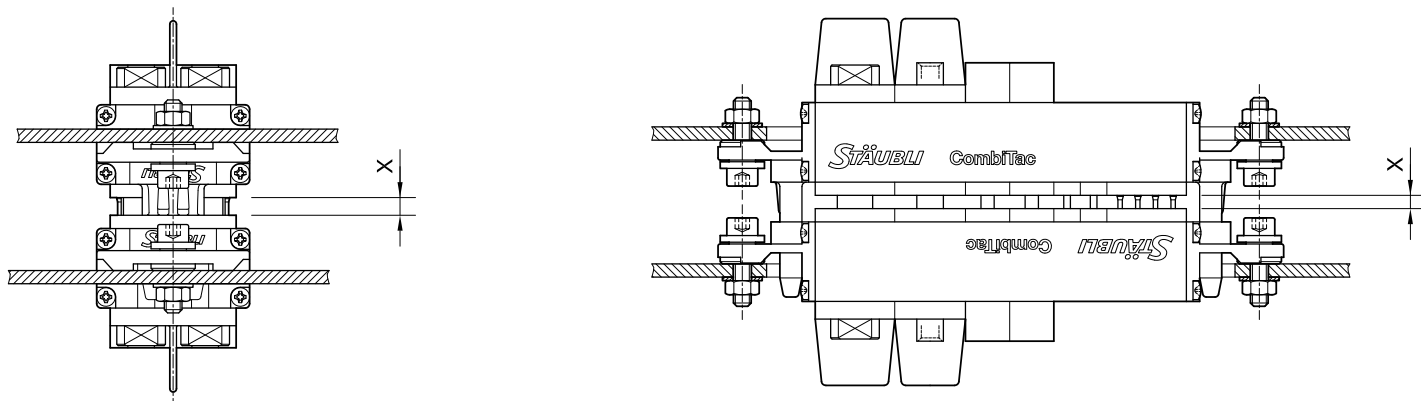

Contacts	Sizes X
	min. > 0 mm; max. mm
CT0.6	1.5
CT1,5	2.75
CT3	2
Further electricals	3
POF crimp version	1.5
POF/SL Lens contact	0.5
CT-.../GOF	2
Coaxial	1.5
Thermocouple pressure contacts	1.5
CT-NET	2
SCT	2
LCT06	1
UCT/RCT	2
CT-E8-2-IP2X	2
CT-LMFB	1
CT-10GBIT	1.5
CT-...3/...-HV	1
CT-...4/...-HV	2

### Plug connections with coupling force and any end position

Coupling forces may not be applied to the plug connectors, frames, and/or guide pins. In cases where these forces exist, the customer must utilize guide pins to protect the connection.

Failure to observe these recommendations can result in damage to the plug connection.

## DIN ALUMINUM HOUSINGS IP65/67

# Standard DIN housings

Aluminum DIN housings are designed to serve general industrial, healthcare and railway applications. Both standard and space saving locking systems are available.

Available in grey and white color depending on size. Other colors available upon request. Housings with cable entries available in other sizes and numbers on request.

### Features depending on type (see table page 89 for details):

- Up to 10,000 mating cycles
- IP65 and IP67 in mated condition
- 6 coding possibilities
- Quick and easy replacement of sealing
- Resistance to shock and vibrations
- IP2X during connecting/disconnecting process when using protective walls
- Ergonomic locking mechanism

- Space saving locking available to save space when placing a high number of housings next to each other

### Benefits:

- Minimum service costs
- Added user safety
- Low maintenance costs
- Reliable solution
- Easy handling

## Coupler hoods/Surface and pedestal mount housings



### Coupler hoods

Can be used with a surface or pedestal mount housing. Available with side or top cable entry, with or without protective wall.

### Surface and pedestal mount housings

Both types are used with coupler hoods. The choice of mount housing depends on the cable entry type. Available with or without protective wall or cover.

## Coupler hoods and surface housings with space saving locking

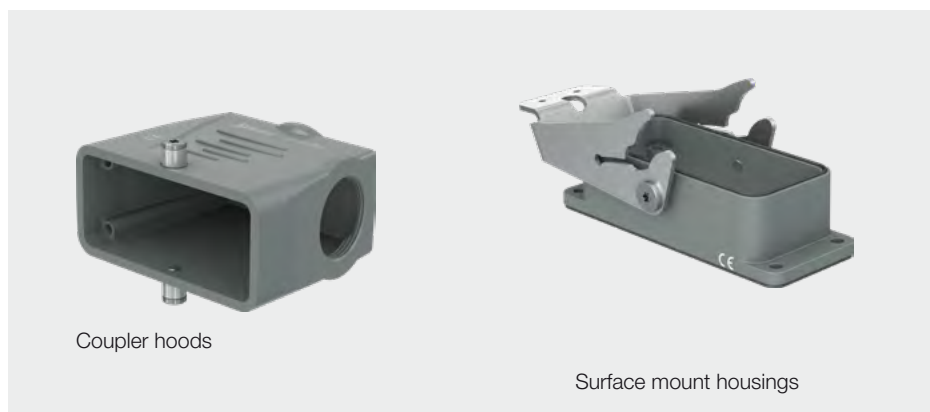

### Coupler hoods

Can be used with a surface mount housing. Available with side or top cable entry.

### Surface mount housings

Used with coupler hoods.

## Accessories

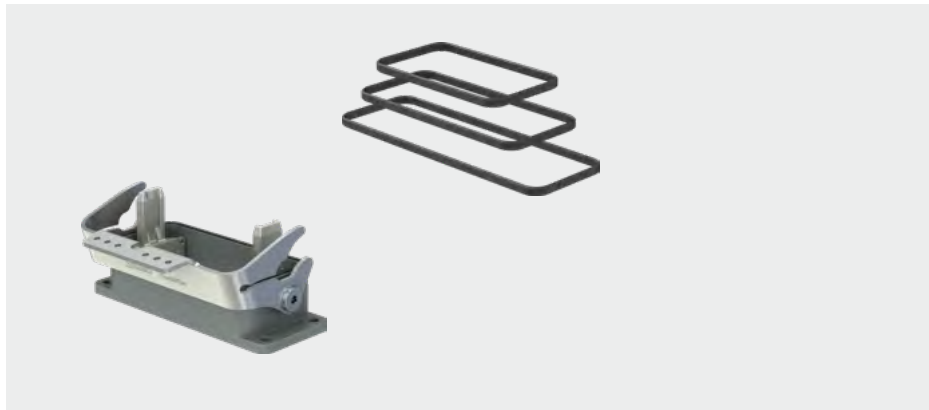

### Park stations

- For parking coupler hoods when not in use

### Replacement seals and locking handle (depending on type)

- Available upon request

## Technical data DIN housings

Technical data	
Housing material	Aluminum
Seal material	NBR
Locking mechanism material	Stainless steel
Vibrations and shock	IEC 61373:2010 Category 1B

## Comparison chart of the different housings

Size	IP65	IP67	Mating cycles	Color	Limiting temperature <sup>2)</sup>	Vibration and shock resistance	Replaceable seal
						IEC 62847:2016	
1	x		5,000	Grey RAL9006	-40 °C to +90 °C		
2	x	x	10,000	Grey RAL7012 White RAL9003	-40 °C to +125 °C short-term operation -40 °C to +90 °C continuous operation	x	x
3	x	x	10,000	Grey RAL7012 White RAL9003	-40 °C to +125 °C short-term operation -40 °C to +90 °C continuous operation	x	x
4	x	x	10,000	Grey RAL7012 White RAL9003	-40 °C to +125 °C short-term operation -40 °C to +90 °C continuous operation	x	x
5	x		5,000	Grey RAL9006	-40 °C to +90 °C		
6	x		5,000	Grey RAL9006	-40 °C to +90 °C		

<sup>1)</sup> Follow maintenance instructions according to MA213

<sup>2)</sup> Maximum temperature permitted on the surface of the housing

# Restrictions concerning the surface mount housing with protective cover

If the max. pin length (see table) is exceeded, or if a surface mount housing is fitted in

combination with end pieces for plugs, the protective cover cannot be closed.

**Note:**

For assembly end pieces in housings, please refer to MA213.

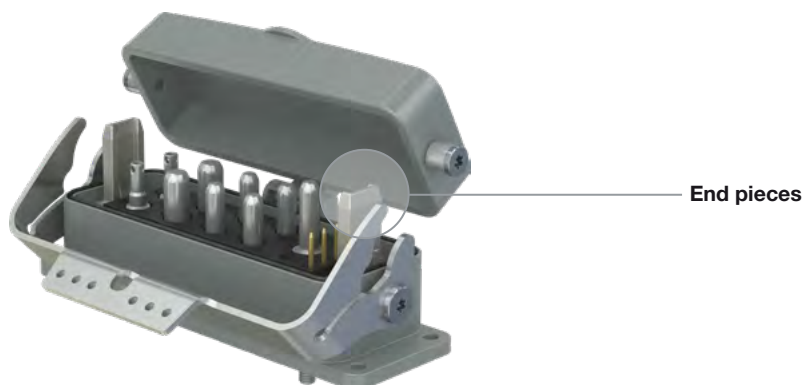

Housing size	Pin length
	max. mm
1	14
2	17
3	17
4	17
5	12
6	16.5

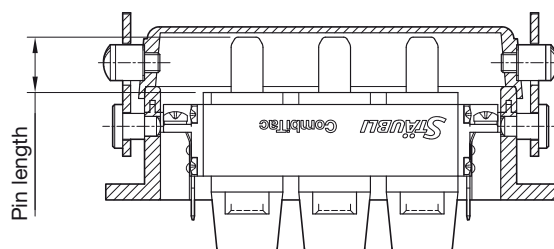

# Calculation of housing size

**Note:**

Minimum length L = 30 mm. The maximum length L of the relevant housing size must be reached. If necessary, fill up with spacers (see page 78).

Type	Number	Width	
CT-E12		x 30 mm	=
CT-E8/6-PE, CT-E6-2		x 16 mm	=
CT-E4-2/HV-...		x 14 mm	=
CT-E8-2, CT-E3-.../HV..., CT-E1-26		x 18 mm	=
CT-E3-3, CT-E3/PCB, CT-E3-2+PE		x 10 mm	=
CT-E1,5-4/HV		x 8 mm	=
CT-E1,5-5, CT-E-2TH+PE		x 6 mm	=
CT-E1-15		x 20 mm	=
CT-E1-6		x 4 mm	=
CT-E0,6-20		x 5.1 mm	=
CT-LMFB		x 6 mm	=
CT-E-COAX, CT-NET		x 16 mm	=
CT-10GBIT		x 22 mm	=
CT-RJ45		x 20 mm	=
CT-E-3POF, CT-E-4GOF		x 6 mm	=
CT-E8-4		x 30 mm	=
<b>Contact carriers</b>	CT-E-UCT06-1	x 18 mm	=
	CT-E-UCT06-2	x 28 mm	=
	CT-E-UCT06-4, CT-E-UCT08-2	x 42 mm	=
	CT-E-UCT08-1	x 22 mm	=
further moduls			
Sum of the widths (min. 30 mm)		<b>L</b>	=
Housing size			
<b>Spacers</b>	CT-DIP0,5	x 0.5 mm	
	CT-DIP1	x 1 mm	=
	CT-DIP2	x 2 mm	=
	CT-DIP3	x 3 mm	=
	CT-DIP4, CT-DIP4/2	x 4 mm	=
further moduls			
Maximum length housing size			=

Size L (mm)	Housing size
18 ≥ L ≤ 30	1
31 ≥ L ≤ 43	2
44 ≥ L ≤ 64	3
65 ≥ L ≤ 90	4
44 ≥ L ≤ 64 44 ≥ L ≤ 64	5
65 ≥ L ≤ 90 65 ≥ L ≤ 90	6

← Maximum length L

**Example**

Type	Number	Width	Total		
CT-E1-26/S...	3	x 18 mm	= 54		
CT-E3-3	3	x 10 mm	= 30		
		L	<b>= 84</b>	Housing size	4

Fill with spacers until max. housing dimension for housing size is reached:

CT-DIP4	1	x 4 mm	= 4		
CT-DIP2	1	x 2 mm	= 2		
		Result	<b>= 90</b>		

# Coupler hood

Coupler hoods can be combined with surface or pedestal mount housing. Available with side or top cable entry.

**Note for sizes 2, 3, 4:**

For white housing please add the color code number 29, e.g. 33.2402-29. Other colors available upon request.

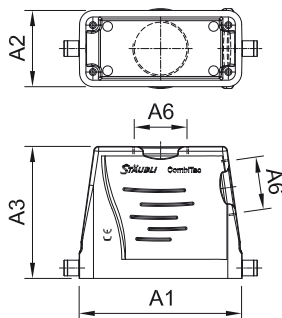

Size	Order No.	Type	IP65	IP67	Cable entry		Sizes (mm)				Standard color
					Side	Top	A1	A2	A3	A6	
1	33.1551	CT-CH1-S	x		x		60	43	72	M32	■
	33.1571	CT-CH1-T	x			x					
2	33.2402	CT-CH2-S	x	x	x		73.8	43.9	70	M32	■ 29
	33.2362	CT-CH2-T	x	x		x					
3	33.2403	CT-CH3-S	x	x	x		93.8	43.9	76	M32	■ 29
	33.2363	CT-CH3-T	x	x		x					
4	33.2404	CT-CH4-S	x	x	x		120.4	43.9	78	M32	■ 29
	33.2364	CT-CH4-T	x	x		x					
5	33.0365	CT-CH5-S	x		x		94	82.5	79	M40	■
	33.0355	CT-CH5-T	x			x					
6	33.0366	CT-CH6-S	x		x		132	90	94	M50	■
	33.0356	CT-CH6-T	x			x					

# Coupler housing

Coupler housings can be combined with coupler hoods. Available with top cable entry.

## CT-CHG...-T

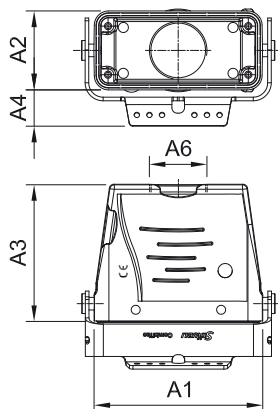

## CT-CHG...-T/PW

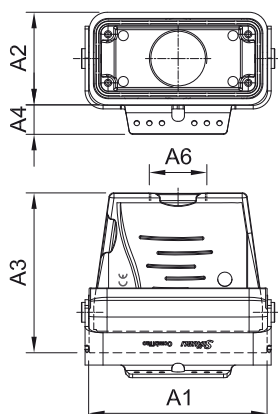

Size	Order No.	Type	IP65	IP67	Cable entry	Protective wall	Sizes (mm)					Standard color
							A1	A2	A3	A4	A6	
					Top							
1	33.1501	CT-CHG1-T	x		x		60	43	75	20	M32	
2	33.5082	CT-CHG2-T	x	x	x		73.8	43.9	70	33.4	M32	29
	33.5092	CT-CHG2-T/PW	x	x		x	78.5	51.5	82.9	29.6		
3	33.5083	CT-CHG3-T	x	x	x		93.8	43.9	76	33.4	M32	29
	33.5093	CT-CHG3-T/PW	x	x		x	99	51.5	88.9	29.6		
4	33.5084	CT-CHG4-T	x	x	x		120.4	43.9	78	33.4	M32	29
	33.5094	CT-CHG4-T/PW	x	x		x	125.2	51.5	90.9	29.6		
5	33.0415	CT-CHG5-T	x		x		95	83.5	82.5	33	M40	



Assembly instructions MA213

[www.staubli.com/electrical](http://www.staubli.com/electrical)

# Coupler hood with protective wall, IP2X

Coupler hoods with protective walls offer additional damage protection to contacts along with IP2X protection during the connecting/disconnecting process. Protective walls are in black.

**Note for sizes 2, 3, 4:**

For white housing please add the color code number 29, e.g. 33.2952-29. Other colors available upon request.

**CT-CH...PW**

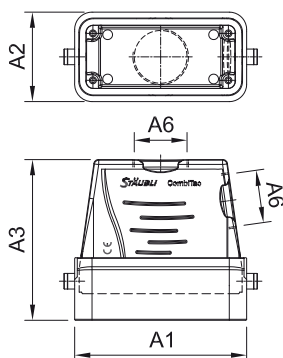

**CT-CH...PW-PC**

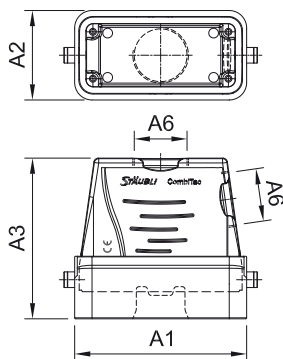

Size	Order No.	Type	IP65	IP67	Cable entry		Sizes (mm)				Standard color
					Side	Top	A1	A2	A3	A6	

**For use with housings, without protective covers**

2	33.2952	CT-CH2-S/PW	x	x	x		78.5	51.5	86.5	M32	■ 29
	33.2912	CT-CH2-T/PW	x	x		x					
3	33.2953	CT-CH3-S/PW	x	x	x		99	51.5	92.5	M32	■ 29
	33.2913	CT-CH3-T/PW	x	x		x					
4	33.2954	CT-CH4-S/PW	x	x	x		125.2	51.5	94.5	M32	■ 29
	33.2914	CT-CH4-T/PW	x	x		x					
5	33.3255	CT-CH5-S/PW	x		x		101	91.2	95.8	M40	■
	33.3275	CT-CH5-T/PW	x			x					
6	33.3256	CT-CH6-S/PW	x		x		136.5	96.5	118.5	M50	■
	33.3276	CT-CH6-T/PW	x			x					

**For use with housings, with protective covers**

2	33.2972	CT-CH2-S/PW-PC	x	x	x		78,5	51,5	86,5	M32	■ 29
	33.2932	CT-CH2-T/PW-PC	x	x		x					
3	33.2973	CT-CH3-S/PW-PC	x	x	x		99	51,5	92,5	M32	■ 29
	33.2933	CT-CH3-T/PW-PC	x	x		x					
4	33.2974	CT-CH4-S/PW-PC	x	x	x		125,2	51,5	94,5	M32	■ 29
	33.2934	CT-CH4-T/PW-PC	x	x		x					
5	33.3295	CT-CH5-S/PW-PC	x		x		101	91,2	95,8	M40	■
	33.3225	CT-CH5-T/PW-PC	x			x					
6	33.3296	CT-CH6-S/PW-PC	x		x		136,5	96,5	118,5	M50	■
	33.3226	CT-CH6-T/PW-PC	x			x					

# Surface mount housing

Surface mount housings are used for bottom cable entry. They are combined with coupler hoods and are available with or without protective wall or cover. Protective walls are in black.

Coupler hoods with protective walls of fer additional damage protection to contacts along with IP2X protection during the connecting/disconnecting process.

**Note for sizes 2, 3, 4:**

For white housing please add the color code number 29, e.g. 33.2302-**29**. Other colors available upon request.

**CT-SM...**

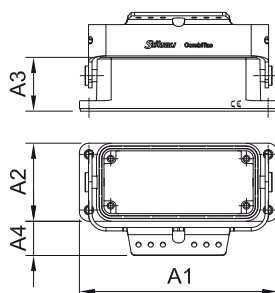



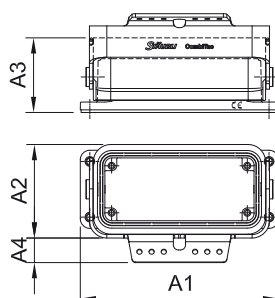

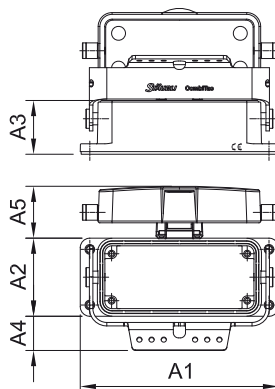

**CT-SM...PW**



**CT-SM...PC**



Size	Order No.	Type	IP65	IP67	Protective cover	Protective wall	Sizes (mm)					Standard color
							A1	A2	A3	A4	A5	
<b>1</b>	<b>33.1561</b>	CT-SM1	x				82	47	29	20.9	-	
	<b>33.1591</b>	CT-SM1-PC	x		x	24.5						
<b>2</b>	<b>33.2302</b>	CT-SM2	x	x			94	44.9	28.5	32.9	-	
	<b>33.2852</b>	CT-SM2/PW	x	x		x		51.5	41.4	29.6	-	
	<b>33.2332</b>	CT-SM2-PC	x	x	x			44.9	28.5	32.9	29.8	
<b>3</b>	<b>33.2303</b>	CT-SM3	x	x			114	44.9	28.5	32.9	-	
	<b>33.2853</b>	CT-SM3/PW	x	x		x		51.5	41.4	29.6	-	
	<b>33.2333</b>	CT-SM3-PC	x	x	x			44.9	28.5	32.9	29.8	
<b>4</b>	<b>33.2304</b>	CT-SM4	x	x			141	44.9	28.5	32.9	-	
	<b>33.2854</b>	CT-SM4/PW	x	x		x		51.5	41.4	29.6	-	
	<b>33.2334</b>	CT-SM4-PC	x	x	x			44.9	28.5	32.9	29.8	
<b>5</b>	<b>33.0375</b>	CT-SM5	x				126.6	89	38	28.9	-	
	<b>33.3235</b>	CT-SM5/PW	x			x		91.2	52	27.8	-	
	<b>33.0385</b>	CT-SM5-PC	x		x			89	37.8	28.9	23	
<b>6</b>	<b>33.0376</b>	CT-SM6	x				167.7	96.7	41.5	51	-	
	<b>33.0386</b>	CT-SM6-PC	x		x	26						

# Pedestal mount housing

Pedestal mount housings are used for left and/or right side cable entry. They are combined with coupler hoods and are available with or without protective wall or cover. Protective walls are black.

Pedestal mount with protective walls offer additional damage protection to contacts along with IP2X protection during the connecting/disconnecting process.

**Note for sizes 2, 3, 4:**

For white housing please add the color code number 29, e.g. 33.2462-29. Other colors available upon request.

**CT-PM...**

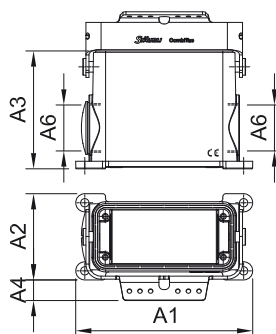



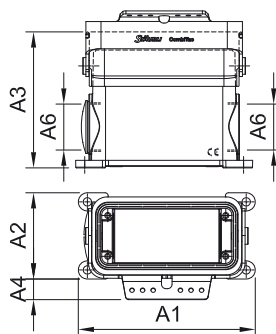

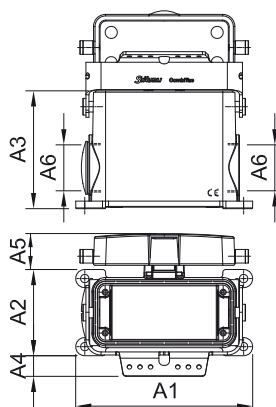

**CT-PM...PW**



**CT-PM...PC**



Size	Order No.	Type	IP65	IP67	Protective cover	Protective wall	Sizes (mm)						Standard color	
							A1	A2	A3	A4	A5	A6		
1	33.1541	CT-PM1	x				82	54.5	74	13.5	-	20	M32	
	33.1581	CT-PM1-PC	x		x									
2	33.2462	CT-PM2	x	x			94	57	74	26.9	-	M32		29
	33.2872	CT-PM2/PW	x	x		x			86.9		-			
	33.2702	CT-PM2-PC	x	x	x				74		23.8			
3	33.2463	CT-PM3	x	x			117	57	77	26.9	-	M32		29
	33.2873	CT-PM3/PW	x	x		x			90		-			
	33.2703	CT-PM3-PC	x	x	x				77		23.8			
4	33.2464	CT-PM4	x	x			144	57	79	26.9	-	M32		29
	33.2874	CT-PM4/PW	x	x		x			92		-			
	33.2704	CT-PM4-PC	x	x	x				79		23.8			
5	33.1025	CT-PM5	x				130.5	92.5	79	27.2	-	M32 <sup>1)</sup>		
	33.2085	CT-PM5/PW	x			x			92.8		-			
	33.1035	CT-PM5-PC	x		x				79		21.4			
6	33.0396	CT-PM6	x				138	120	100	39.4	-	M40		
	33.0406	CT-PM6-PC	x		x						14.5			

<sup>1)</sup> M40 without adapter

# Park stations

Used for parking coupler hoods when they are not connected to mount housings.

**Note for sizes 2, 3, 4:**

For white housing please add the color code number 29, e.g. 33.2362-29. Other colors available upon request.

**CT-PS...SM/P**

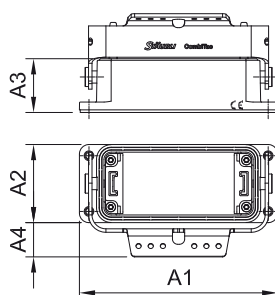

**CT-PS...SM/S**

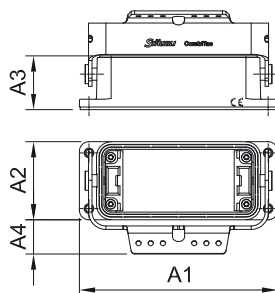

**CT-PS...PC-SM/S**

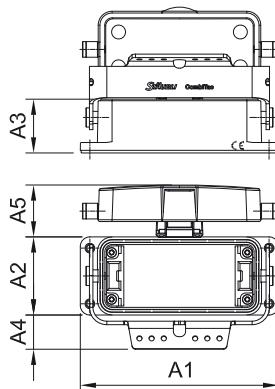

Size	Order No.	Type	IP65	IP67	Pin end pieces	Socket end pieces	Protective cover	Sizes (mm)					Standard color
								A1	A2	A3	A4	A5	
1	34.0340	CT-PS1-SM/P	x		x			82	47	29	20.9		
	34.0341	CT-PS1-SM/S	x			x							
2	33.1802	CT-PS2-SM/P	x	x	x			94	44.9	28.5	32.9	29.8	■ 29
	33.1812	CT-PS2-SM/S	x	x		x							
	33.1832	CT-PS2/PC-SM/S	x	x		x	x						
3	33.1803	CT-PS3-SM/P	x	x	x			114	44.9	28.5	32.9	29.8	■ 29
	33.1813	CT-PS3-SM/S	x	x		x							
	33.1833	CT-PS3/PC-SM/S	x	x		x	x						
4	33.1804	CT-PS4-SM/P	x	x	x			141	44.9	28.5	32.9	29.8	■ 29
	33.1814	CT-PS4-SM/S	x	x		x							
	33.1834	CT-PS4/PC-SM/S	x	x		x	x						
5	34.0354	CT-PS5-SM/P	x		x			126.6	89	38	28.9	23	■
	34.0355	CT-PS5-SM/S	x			x							
	34.0358	CT-PS5/PC-SM/S	x			x	x						
6	34.0356	CT-PS6-SM/P	x		x			167.7	96.7	41.5	51	26	■
	34.0357	CT-PS6-SM/S	x			x							
	34.0359	CT-PS6/PC-SM/S	x			x	x						

## Replacement seals

Replacement housing seals made of NBR can be reordered.



CT-DDI-SM...



CT-PDI-SM...

Size	Order No.	Type	Description
2	33.2782	CT-DDI-SM2	Upper seal
3	33.2783	CT-DDI-SM3	
4	33.2784	CT-DDI-SM4	
2	33.2792	CT-PDI-SM2	Lower seal
3	33.2793	CT-PDI-SM3	
4	33.2794	CT-PDI-SM4	

# Protective cap

For mounting on all surface and pedestal mountings or coupler hood with pin end pieces. Protective cap with safety cord suitable for all pin lengths.

Protective cover material: PA.

**Note:**

It is not possible to use the protective cap together with a protective wall.



Size	Order No.	Type	for metal housing
1	33.1301	CT-PC-SM1-L/FSCH	x
2	33.1302	CT-PC-SM2-L/FSCH	x
3	33.1303	CT-PC-SM3-L/FSCH	x
4	33.1304	CT-PC-SM4-L/FSCH	x
5	33.1305	CT-PC-SM5-L/FSCH	x
6	33.1306	CT-PC-SM6-L/FSCH	x



## DIN ALUMINUM HOUSINGS IP65/67 WITH SPACE SAVING LOCKING

# Coupler hood

Coupler hoods can be combined with surface mount housing. Available with side or top cable entry.

### Note for sizes 2, 3, 4:

For white housing, please add the color code number 29, e.g. 35.1242-29. Other colors available upon request.

### CT-CH...-S/SSL

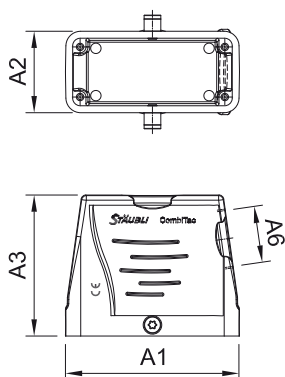

### CT-CH...-T/SSL

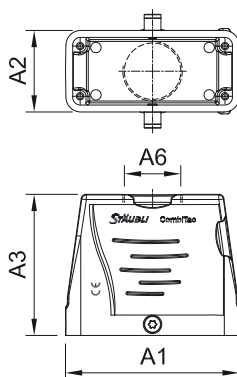

Size	Order No.	Type	IP67	Cable entry		Sizes (mm)				Standard color
				Side	Top	A1	A2	A3	A6	
2	35.1242	CT-CH2-S/SSL	x	x		73.8	43.9	70	M32	29
	35.1232	CT-CH2-T/SSL	x		x					
3	35.1243	CT-CH3-S/SSL	x	x		93.8	43.9	76	M32	29
	35.1233	CT-CH3-T/SSL	x		x					
4	35.1244	CT-CH4-S/SSL	x	x		120.8	43.9	78	M32	29
	35.1234	CT-CH4-T/SSL	x		x					

# Surface mount housing

Surface mount housings are used for bottom cable entry. They are combined with coupler hoods.

**Note for sizes 2, 3, 4:**

For white housing, please add the color code number 29, e.g. 35.1252-**29**. Other colors available upon request.

CT-SM...

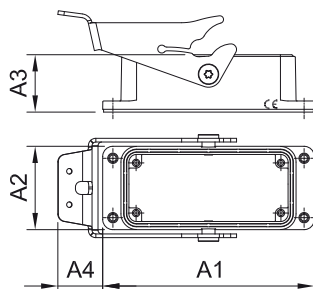

Size	Order No.	Type	IP67	Sizes (mm)					Standard color
				A1	A2	A3	A4		
							Locked	Unlocked	
2	35.1252	CT-SM2/SSL	x	94	44.9	28.5	3.3	26	■ 29
3	35.1253	CT-SM3/SSL	x	114	44.9	28.5	7.8	31	■ 29
4	35.1254	CT-SM4/SSL	x	141	44.9	28.5	3.9	30	■ 29

# Park stations

Used for parking coupler hoods when they are not connected to mount housings.

Includes CombiTac uniq frames.

**Note for sizes 2, 3, 4:**

For white housing, please add the color code number 29, e.g. 33.2362-29. Other colors available upon request.

**CT-PS...-SM/SSL/P**

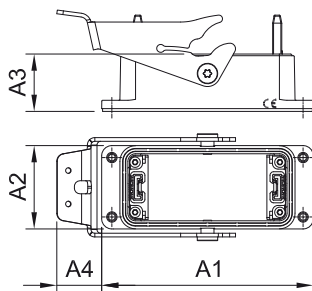

**CT-PS...-SM/SSL/S**

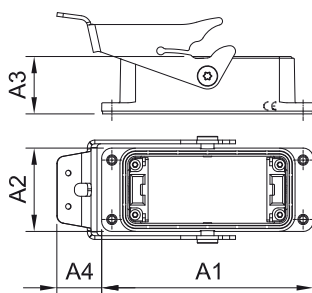

Size	Order No.	Type	IP67	Pin end pieces	Socket end pieces	Sizes (mm)					Standard color
						A1	A2	A3	A4		
									Locked	Unlocked	
2	33.1742	CT-PS2-SM/SSL/P	x	x		94	44.9	28.5	3.3	26	29
	33.1782	CT-PS2-SM/SSL/S	x		x						
3	33.1743	CT-PS3-SM/SSL/P	x	x		114	44.9	28.5	7.8	31	29
	33.1783	CT-PS3-SM/SSL/S	x		x						
4	33.1744	CT-PS4-SM/SSL/P	x	x		141	44.9	28.5	3.9	30	29
	33.1784	CT-PS4-SM/SSL/S	x		x						

# Replacement seals

Replacement housing seals made of NBR can be reordered.

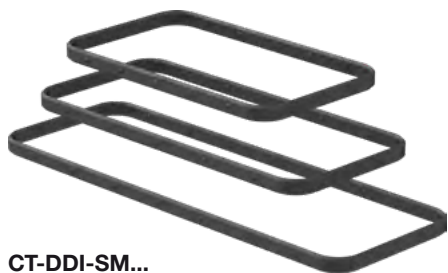

CT-DDI-SM...



CT-PDI-SM...

Size	Order No.	Type	Description
2	33.2782	CT-DDI-SM2	Upper seal
3	33.2783	CT-DDI-SM3	
4	33.2784	CT-DDI-SM4	
2	33.2792	CT-PDI-SM2	Lower seal
3	33.2793	CT-PDI-SM3	
4	33.2794	CT-PDI-SM4	

DIN ALUMINUM HOUSING IP68/69K

Coupler hood

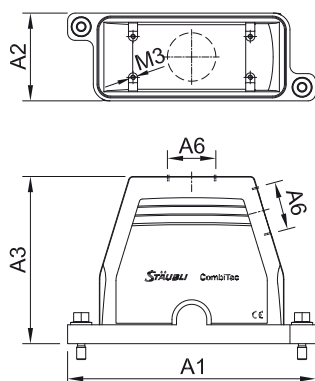

The all-round contact of the two housing halves of the IP68/69K enclosures provides a 360° shielding against electromagnetic influence according to VG 95373-41.

Size	Order No.	Type	Cable entry		Sizes (mm)			
			Side	Top	A1	A2	A3	A6
1	33.6871	CT-TG1-S IP68 HE	×		132	58	100.5	M32
	33.6881	CT-TG1-G IP68 HE		×				
2	33.6872	CT-TG2-S IP68 HE	×		144	58	100.5	M32
	33.6882	CT-TG2-G IP68 HE		×				
3	33.6873	CT-TG3-S IP68 HE	×		164	58	110.5	M40
	33.6883	CT-TG3-G IP68 HE		×				
4	33.6874	CT-TG4-S IP68 HE	×		191	58	110.5	M40
	33.6884	CT-TG4-G IP68 HE		×				

Surface mount housing

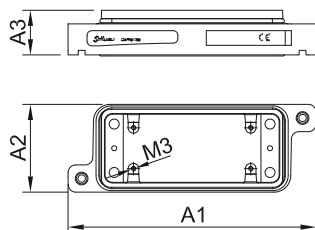

Size	Order No.	Type	Sizes (mm)		
			A1	A2	A3
1	33.6851	CT-AG1 IP68 HE	132	58	29.5
2	33.6852	CT-AG2 IP68 HE	144	58	29.5
3	33.6853	CT-AG3 IP68 HE	164	58	29.5
4	33.6854	CT-AG4 IP68 HE	191	58	29.5

# Pedestal mount housing

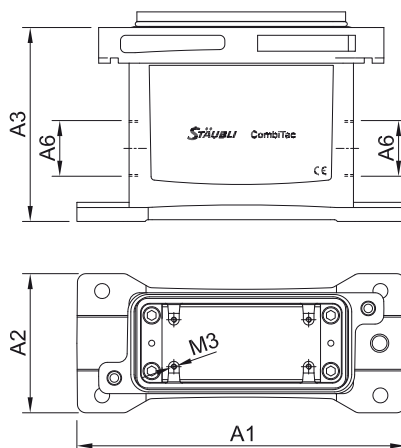

Size	Order No.	Type	Sizes (mm)			
			A1	A2	A3	A6
1	33.6861	CT-SG1 IP68 HE	156	80	100.5	2×M32
2	33.6862	CT-SG2 IP68 HE	169	80	100.5	2×M32
3	33.6863	CT-SG3 IP68 HE	189	80	111.5	2×M32
4	33.6864	CT-SG4 IP68 HE	216	80	111.5	2×M40

# Protective cap



Size	Order No.	Type
1	33.6891	CT-PC1 IP68 HE
2	33.6892	CT-PC2 IP68 HE
3	33.6893	CT-PC3 IP68 HE
4	33.6894	CT-PC4 IP68 HE

CENTRAL LOCKING IP65

Central locking IP65 (on request)

CT-CH.../ZV

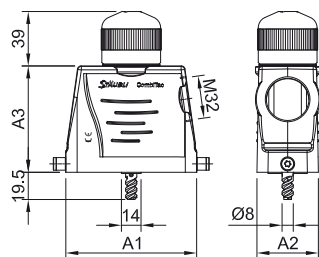

CT-SM.../ZV

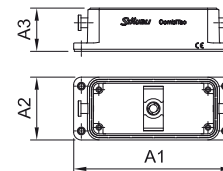

Size	Order No.	Type	Designation	Sizes (mm)			Standard color
				A1	A2	A3	
	<b>33.1418</b>	CT-ZV/B	Locking head complete	-	-	-	
2	<b>33.4018-2</b>	CT-E-ZV/B/TG2	Carrier with threaded spindle	-	-	-	
3	<b>33.4018-3</b>	CT-E-ZV/B/TG3		-	-	-	
4	<b>33.4018-4</b>	CT-E-ZV/B/TG4		-	-	-	
	<b>33.4021</b>	CT-E-ZV/S	Thread carrier	-	-	-	
2	<b>33.1862</b>	CT-CH2/ZV-R	Coupler hood for central locking	73.8	43.9	70	29
3	<b>33.1863</b>	CT-CH3/ZV-R		93.8	43.9	76	
4	<b>33.1864</b>	CT-CH4/ZV-R		120.4	43.9	78	
2	<b>33.1852</b>	CT-SM2/ZV	Surface mount housing for central locking	94	44.9	28.5	29
3	<b>33.1853</b>	CT-SM3/ZV		114	44.9	28.5	
4	<b>33.1854</b>	CT-SM4/ZV		141	44.9	28.5	

## DIN PLASTIC HOUSING IP65

# Plastic housing

The plastic housing is primarily intended for industrial use or for applications where a high resistance to chemical environmental influences is required.

In addition, the plastic housing is mechanically robust.

As the housing is made of antistatic thermoplastic material, there is no need for additional grounding.



### Technical data

Housing material	Thermoplastic
Housing seal	Elastomer
Locking element	Thermoplastic
Degree of protection mated/locked	IP65

**Plastic housing – Resistance to aggressive media**

	Resistant	Limited resistance
1-Pentanol		x
Alum	x	
Amide, aqueous	x	
Ammonia gas		x
Ammonia, 10 % aqueous solution	x	
Ammonium acetate	x	
Ammonium carbonate	x	
Ammonium chloride	x	
Ammonium nitrate	x	
Ammonium phosphate	x	
Ammonium sulfate	x	
Aniline		x
Asphalt		x
Beer	x	
Borated water	x	
Borax		x
Boric acid, 10 % aqueous solution	x	
Boric acid	x	
Butane gas		x
Butane, liquid		x
Calcium chloride, 10 % aqueous solution	x	
Calcium chloride	x	
Calcium nitrate	x	
Calcium sulfate	x	
Chlorinated lime, diluted	x	
Copper sulfate, 10 % aqueous solution	x	
Cresol acids		x
Cresol solution		x
Cutting oil		x
Cyclohexane		x
Diesel		x
Diisononyl phthalate	x	
Di-Octyl-Phthalate	x	
Diluted glucose	x	
Diluted glycerol	x	
Diluted glycol	x	
Diluted phenol		x
Ethanol, non-denaturized	x	
Ethylene glycol or propylene glycol	x	
Fatty acids	x	
Fruit juices	x	
Gasoline		x

**Plastic housing – Resistance to aggressive media**

	Resistant	Limited resistance
Glycerol	x	
Grinding oil		x
Gypsum (see calcium sulfate)	x	
Heptane		x
Hexane		x
Hydrogen sulfide		x
Ink	x	
Isopropyl alcohol		x
Lactic acid	x	
Linseed oil	x	
Lubricating oil	x	
Mercury	x	
Methanol, diluted by 50 %		x
Mineral oil	x	
Mineral spirits (Avio)		x
Mineral-based oil	x	
Mothballs		x
Motor oil		x
n-Butanol	x	
Naphthalene		x
Octane		x
Oil IRM 901, 20 °C	x	
Oil IRM 902, 20 °C		x
Oil IRM 903, 20 °C		x
Oil		x
Oleic acid	x	
Oxalic acid	x	
Paraffin oil	x	
Petroleum	x	
Phthalate	x	
Potassium carbonate	x	
Potassium chlorate	x	
Potassium chloride	x	
Potassium chromate		x
Potassium cyanide, aqueous solution	x	
Potassium iodide		x
Potassium nitrate		x
Potassium persulfate		x
Potassium sulfate		x
Seawater	x	
Silicone oil	x	
Soap solution		x

Plastic housing – Resistance to aggressive media		
	Resistant	Limited resistance
Sodium bicarbonate	x	
Sodium carbonate	x	
Sodium chlorate	x	
Sodium chloride (table salt)	x	
Sodium hydrogen sulfate, aqueous solution	x	
Sodium hydroxide 12.5 % (alkaline solution)		x
Sodium nitrate	x	
Sodium nitrite		x
Sodium perborate	x	
Sodium phosphate	x	
Sodium silicate	x	
Sodium sulfate	x	
Sodium sulfide	x	
Sodium thiosulfate (fixing salt/developing film)	x	
Solution for developing photographs	x	
Stearic acid	x	
Succinic acid	x	
Sulfur dioxide		x
Sulfur	x	
Table salt, aqueous solution	x	
Tallow	x	
Tartaric acid	x	
Tar		x
Transformer oil	x	
Tricresyl phosphate	x	
Turpentine substitute		x
Urea, diluted	x	
Urine	x	
Vegetable oil	x	
Water	x	
White spirits (isopropanol and ethanol)		x

# Coupler hood

CT-TG1-S TP

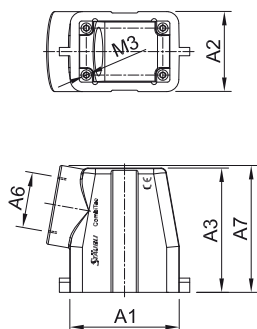

CT-TG...-G TP

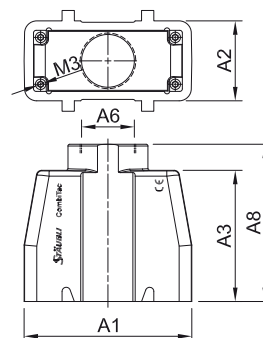

Size	Order No.	Type	Cable entry		Sizes (mm)					
			Side	Top	A1	A2	A3	A6	A7	A8
1 <sup>1)</sup>	33.6011	CT-TG1-S TP	x		63	46	71.5	M32	73	86.5
	33.6021	CT-TG1-G TP		x						
2	33.6012	CT-TG2-S TP	x		76	46	71.5	M32	73	86.5
	33.6022	CT-TG2-G TP		x						
3	33.6013	CT-TG3-S TP	x		96.5	46	75.5	M32	79	90.5
	33.6023	CT-TG3-G TP		x						
4	33.6014	CT-TG4-S TP	x		123	46	75.5	M32	79	90.5
	33.6024	CT-TG4-G TP		x						

# Surface mount housing

CT-AG1 TP

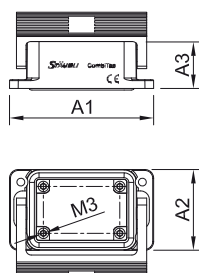

CT-AG...TP

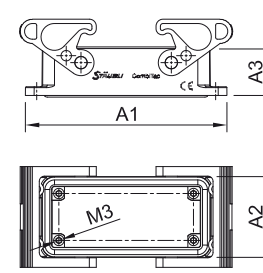

Size	Order No.	Type	Sizes (mm)		
			A1	A2	A3
1 <sup>1)</sup>	33.6041	CT-AG1 TP	83	46	27
2	33.6042	CT-AG2 TP	96	46	27
3	33.6043	CT-AG3 TP	116	46	27
4	33.6044	CT-AG4 TP	143	46	27

<sup>1)</sup> Size 1: housings only have a single locking device.

# Pedestal mount housing

CT-SG1 TP

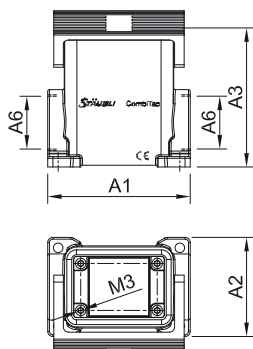

CT-SG...TP

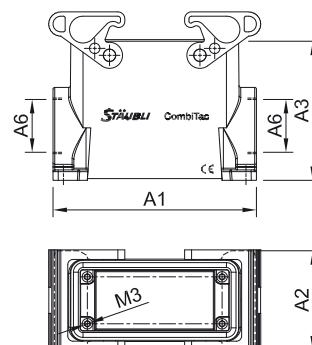

Size	Order No.	Type	Sizes (mm)			
			A1	A2	A3	A6
1 <sup>1)</sup>	33.6601	CT-SG1 TP	82	57	73	M32
2	33.6602	CT-SG2 TP	94	57	80	M32
3	33.6603	CT-SG3 TP	117	57	80	M32
4	33.6604	CT-SG4 TP	144	57	80	M32

# Protective cap

CT-SD-AG1 TP



CT-SD-AG... TP



Size	Order No.	Type
1 <sup>1)</sup>	33.6031	CT-SD-AG1 TP
2	33.6032	CT-SD-AG2 TP
3	33.6033	CT-SD-AG3 TP
4	33.6034	CT-SD-AG4 TP

<sup>1)</sup> Size 1: housings only have a single locking device.

# Park station plastic housing

Park station with plug end pieces to fit coupler hood socket side (picture top).

Park station with socket end pieces to fit coupler hood pin side (picture bottom).

## CT-AG...TP PS/S

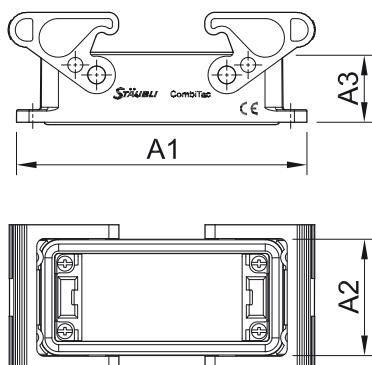

## CT-AG...TP PS/B

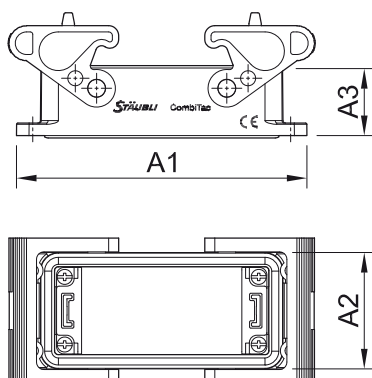

Size	Order No.	Type	End pieces		Sizes (mm)		
			Pin	Socket	A1	A2	A3
1	33.0340	CT-AG1TP PS/S	x		83	46	27
	33.0341	CT-AG1TP PS/B		x			
2	33.0342	CT-AG2TP PS/S	x		96	46	27
	33.0343	CT-AG2TP PS/B		x			
3	33.0344	CT-AG3TP PS/S	x		116	46	27
	33.0345	CT-AG3TP PS/B		x			
4	33.0346	CT-AG4TP PS/S	x		143	46	27
	33.0347	CT-AG4TP PS/B		x			



## PROTECTIVE GROUNDING OF CONDUCTIVE HOUSINGS

# Protective grounding of conductive housings

Appropriate ground protection is available for conductive DIN housings to protect the users against electrical shock, according to IEC 61140:2016<sup>1)</sup>.

CombiTac conductive housings can be grounded internally through its end pieces or the CombiTac PE module.

### Protective grounding through end pieces

For live conductors 0.14 mm<sup>2</sup> – 6 mm<sup>2</sup>

(AWG 26 – 10)

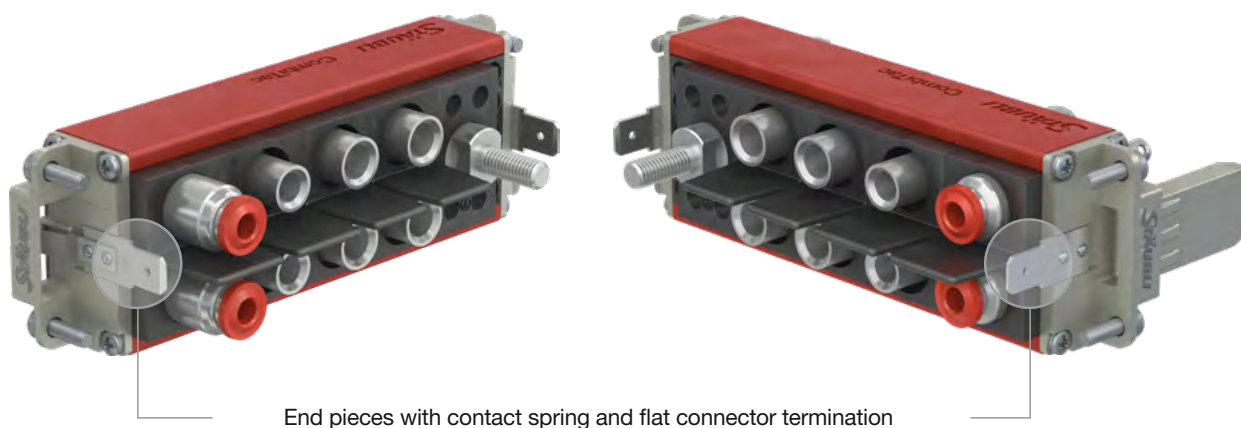

### Protective grounding through PE module

For live conductors 10 mm<sup>2</sup> – 95 mm<sup>2</sup>

(AWG 8 – 3/0)

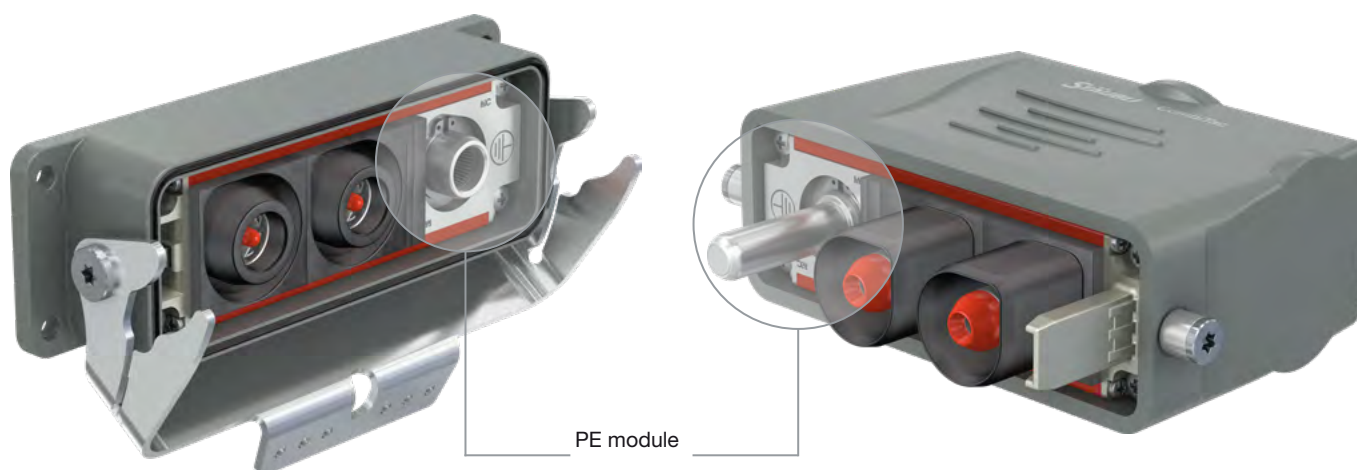

<sup>1)</sup> For voltages > DC 60 V or > AC 30 V, metal (conductive) housings must be connected to protective earth (PE).

# Protective grounding internally through end pieces

Conductive DIN housings that include live conductors with cross section areas 0.14 mm<sup>2</sup> – 6 mm<sup>2</sup> (AWG 26 – 10) can be protective grounded through the CombiTac end pieces.

**Type of termination:**

- Flat connector termination 6.3 mm x 0.8 mm

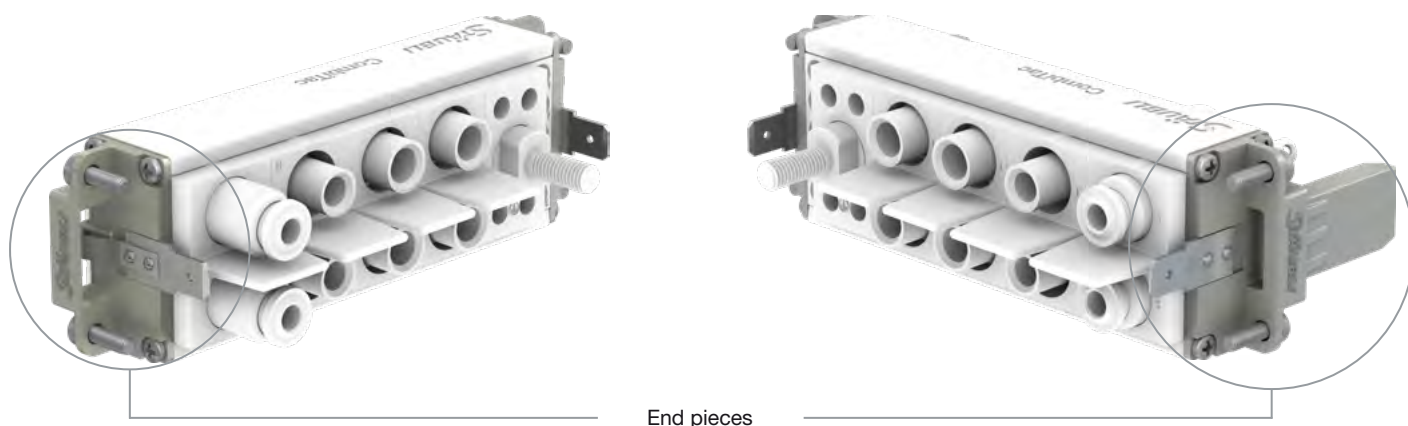

Order No.	Type	Designation	Number per frame		
			Socket	Pin	
33.4056	CT-BEG-B	Standard end piece for DIN housing, socket	2		
33.4057	CT-BEG-S	Standard end piece for DIN housing, pin		2	

## PE MODULE

# PE module

The CombiTac PE module is used for internal protective grounding of CombiTac conductive housings size 2 – 6.

The PE module carrier replaces one of the end pieces and is directly connected to the housing.

- The size of the PE module contacts is determined by the cross section area of the largest live conductor used in the CombiTac configuration (see selection table page 122).

- Aluminum rails are required to ensure correct protective grounding of conductive housings.
- Fitted with MULTILAM

### CT-GND10 AG

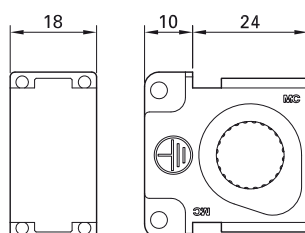

Order No.	Type	Description
33.4165	CT-GND10 AG	PE module carrier

Technical data	
Number of poles	1
For contact diameter	10 mm
Contact carrier material	Brass
Limiting temperature (IEC 61984:2008), upper	+90 °C
lower	-40 °C



E229145

### Required tools

For the required tools please refer to MA213-09.



Assembly instructions MA213-09

[www.staubli.com/electrical](http://www.staubli.com/electrical)

# PE module contacts

For protective grounding purposes only, used in combination with CT-GND10 carrier. Fitted with MULTILAM.

**Type of termination:**

- Crimp termination (C)
- Contacts secured in carrier by means of retaining ring

CT-BP10/.../PE-GND AG

CT-SP10/.../PE-GND AG



Socket side

Pin side

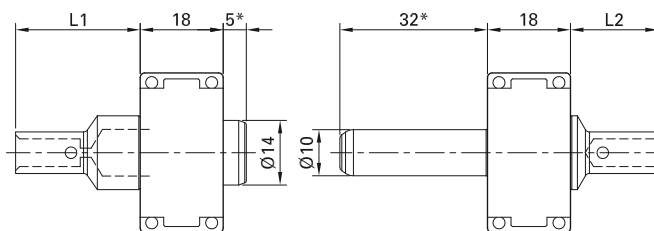

Order No.	Type	Socket	Pin	Surface	Conductor cross section		Short circuit current		Type of termination
					mm <sup>2</sup>	AWG	1s kA	3s kA	
33.0215 33.0715	CT-BP10/10/PE-GND AG CT-SP10/10/PE-GND AG	x	x		10	8	1.5	0.8	C
33.0214 33.0714	CT-BP10/16/PE-GND AG CT-SP10/16/PE-GND AG	x	x		16	6	2.3	1.3	C
33.0216 33.0716	CT-BP10/25/PE-GND AG CT-SP10/25/PE-GND AG	x	x		25		2.3	1.5	C
33.0217 33.0717	CT-BP10/AWG4/PE-GND AG CT-SP10/AWG4/PE-GND AG	x	x			4	2.3	1.5	C
33.0213 33.0713	CT-BP10/35/PE-GND AG CT-SP10/35/PE-GND AG	x	x		35	2	2.3	1.5	C
33.0212 33.0712	CT-BP10/50/PE-GND AG CT-SP10/50/PE-GND AG	x	x		50	1/0	2.3	1.5	C

**Technical data**

Nominal-Ø socket/pin	10 mm
Average sliding force	11 N
Connector resistance	<60 µΩ
Mating cycles	10,000
Vibrations	4.2 g/5 Hz – 250 Hz (IEC 61373:2010) 10 g/10 Hz – 500 Hz (IEC 60068-2-6)
Resistance to shocks	30 g/18 ms (IEC 61373:2010)

\* Sizes are the same for all types of terminations.



**Assembly instructions MA213-09**

[www.staubli.com/electrical](http://www.staubli.com/electrical)

# PE module contacts selection table

According to IEC 61984:2008, the size of a PE conductor cross section depends on the size of the live conductor cross section. In a CombiTac configuration, the size of the largest live conductor determines the size of the PE conductor.

For example, if Ø 12 mm CombiTac contacts are used with 95 mm<sup>2</sup> live conductor cross sections, then a 50 mm<sup>2</sup> PE conductor is required (i.e. requires CT-SP10/50/... and CT-BP10/50/...).

The table below indicates the suitable PE contacts and housing size.

		mm <sup>2</sup> AWG	mm <sup>2</sup> AWG	mm <sup>2</sup> AWG	mm <sup>2</sup> AWG	mm <sup>2</sup> AWG	mm <sup>2</sup> AWG	mm <sup>2</sup> AWG	mm <sup>2</sup> AWG
Largest live conductor cross section		<b>10</b> 8	<b>16</b> 6	<b>25</b> 4	<b>35</b> 2	<b>50</b> –	– 1/0	<b>70</b> 2/0	<b>95</b> 3/0
Required PE conductor cross section according to IEC 61984:2008		<b>10</b> 8	<b>16</b> 6	<b>16</b> 6	<b>16</b> 6	<b>25</b> –	– 4	<b>35</b> 2	<b>50</b> 1/0
Suitable PE module pins/socket	CT-SP10/10/PE-GND AG	x							
	CT-BP10/10/PE-GND AG	x							
	CT-SP10/16/PE-GND AG		x	x	x				
	CT-BP10/16/PE-GND AG		x	x	x				
	CT-SP10/25/PE-GND AG					x			
	CT-BP10/25/PE-GND AG					x			
	CT-SP10/AWG4/PE-GND AG						x		
	CT-BP10/AWG4/PE-GND AG						x		
	CT-SP10/35/PE-GND AG							x	
	CT-BP10/35/PE-GND AG							x	
	CT-SP10/50/PE-GND AG								x
	CT-BP10/50/PE-GND AG								x
Suitable housing size	<b>2</b>	x	x	x	x				
	<b>3</b>	x	x	x	x	x	x	x	x
	<b>4</b>	x	x	x	x	x	x	x	x
	<b>5</b>	x	x	x	x	x	x	x	x
	<b>6</b>	x	x	x	x	x	x	x	x

CODING

# Coding

CombiTac in housings can be coded by fitting coding pins in place of the fixing screws. A total of 6 coding variants are possible.

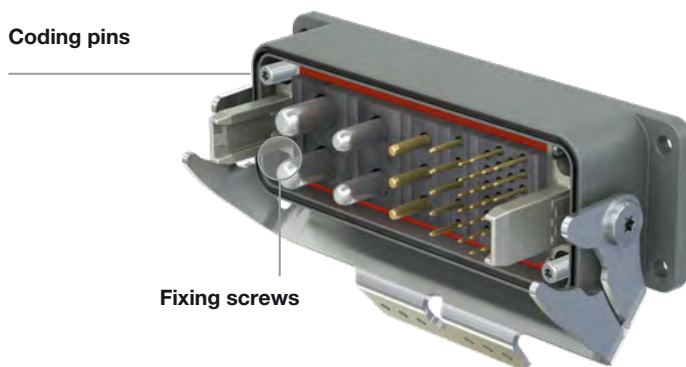

Order No.	Type
33.2887	CT-CN-GF-TORX

## Coding variants

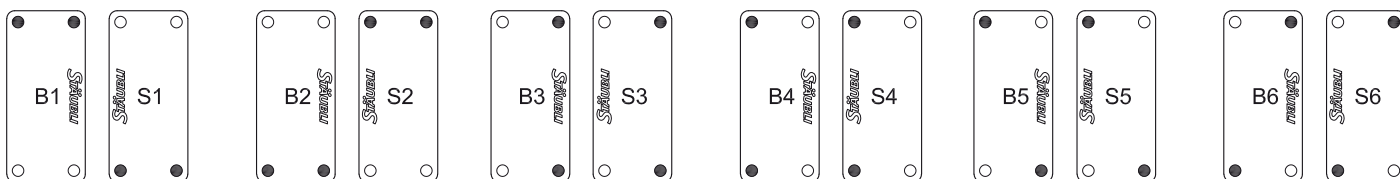

S = Pin side

B = Socket side

• = Coding pin CT-CN-GF-TORX  
standard delivery

**Note:**

Coding B2/S2 is standard delivery, unless ordered customized.

If the contacts are arranged symmetrically, a pole reversal is possible with the following codings: S5/B5, S6/B6, S1/B2, S2/B1, S3/B4, S4/B3, S5/B6, S6/B5. Coding can nev-

ertheless be achieved by means of spacers, see page 78.

If modules of type CT-12 or CT-0.6 are included, no coding is necessary (asymmetrical configuration).

CRIMPING PLIERS

Crimping the electric contacts

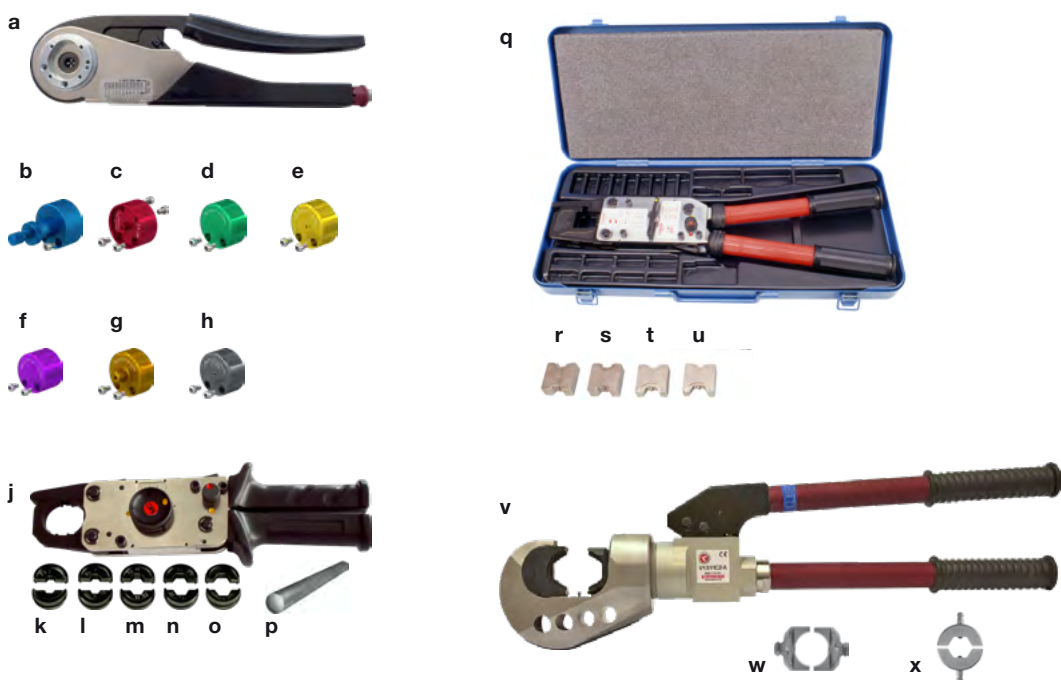

Pos.	Order No.	Type	Conductor cross section mm <sup>2</sup>	Description	
a	33.3800	CT-M-CZ		Crimping pliers	MA079 MA213-11
b	18.3801	MES-CZ	0.14 – 4	Locator adjustable (except for Ø 0.6 mm contacts)	MA079
c	18.3809	MES-CZ-CT0,6	0.14 – 0.25	Locator	
d	18.3804	MES-CZ-CT1	0.25 – 0.75	Locator	
e	18.3805	MES-CZ-CT1,5	0.5 – 1.5	Locator	
f	18.3810	MES-CZ-CT1,5-HV	0,5 – 1,5	Locator	
g	18.3806	MES-CZ-CT3	2.5 – 4	Locator	MA079 MA213-11
h	18.3808	MES-CZ-CT0,6-COAX-RG		Locator for Coaxial unit 6 GHz	
j	18.3700	M-PZ13		Crimping pliers	MA224
k	18.3701	MES-PZ-TB5/6	6	Insert	
l	18.3702	MES-PZ-TB8/10	10	Insert	
m	18.3703	MES-PZ-TB9/16	16	Insert	
n	18.3704	MES-PZ-TB11/25	25	Insert	
o	18.3707	MPS-PZ13		Test insert	
p	18.3708	MALU-PZ13		Round test rod	
q	18.3710	M-PZ-T2600		Crimping pliers with case	MA213-01 MA226
r	18.3712	TB9-13	16 + 35	Insert	
s	18.3713	TB11-14,5	50	Insert	
t	18.3711	TB8-17	10 + 70	Insert	
u	18.3714	TB7-20	95	Insert	MA427
v	70740141	V1311C2-A	120	Crimping pliers on request	
w	11006845	V1330		Insert holder	
x		B22		Crimping die	

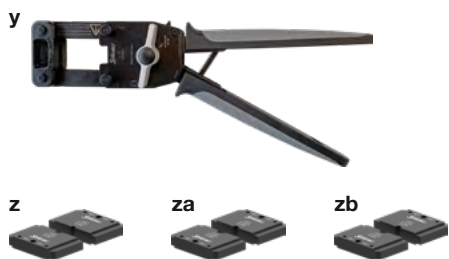

Pos.	Order No.	Type	Conductor cross section	Description	
			mm <sup>2</sup>		
y	33.3930	CT-CP		Crimping pliers	MA420 MA213-05
z	33.3931	CT-I-CP-4	2.5 – 4	Crimping die	
za	33.3932	CT-I-CP-6	6	Crimping die	
zb	33.3933	CT-I-CP-10	10	Crimping die	

## Crimping the 1.5 GHz coaxial contacts

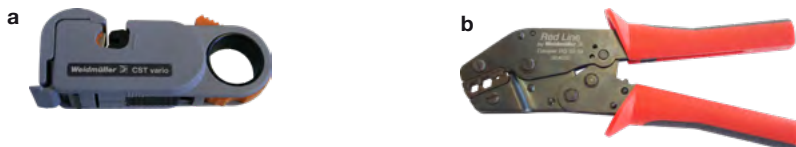

Pos.	Order No.	Type	Description	
a	33.3011	CT-AIWZ/COAX	Insulation stripper for Coaxial unit 1.5 GHz	MA213-02
b	33.3010	CT-CZ/COAX	Crimping pliers for shield and inner conductor for Coaxial unit 1.5 GHz	MA213-02



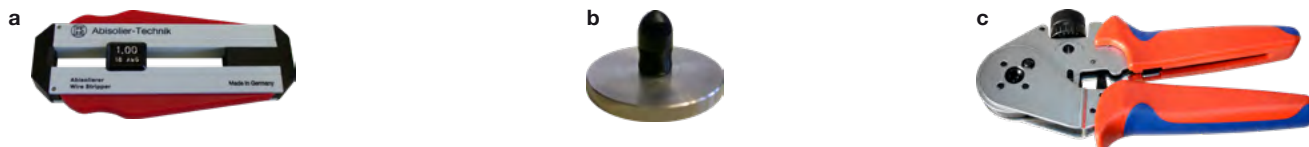

## Crimping the plastic optical fiber contacts



Pos.	Order No.	Type	Description	
a	33.3021	CT-AIWZ/POF	Insulation stripper	MA213-03
b	33.3023	CT-PS/POF	Polishing disc	MA213-03
c	33.3020	CT-CZ/POF	Crimping pliers	MA065, MA213-03

## ASSEMBLY TOOLS







# Insertion tools socket/pin



Insertion tool	Order No.	Type	For nominal-Ø socket/pin	For contact
	<b>33.3003</b>	CT-E-WZ0,6	0.6 mm	
	<b>33.3001</b>	CT-E-WZ1-9,5	1 mm	Thermocouple contacts
	<b>18.3003</b>	ME-WZ1,5/2	1.5 mm	
	<b>18.3010</b>	ME-WZ3	3 mm	
	<b>18.3013</b>	ME-WZ5	6 mm	CT-POF/SL Coaxial contacts
	<b>18.3016</b>	ME-WZ6	8 mm	
	<b>18.3015</b>	MSA-WZ5 <sup>1)</sup>	6 mm	
	<b>18.3018</b>	MSA-WZ6 <sup>1)</sup>	8 mm	
	<b>18.3014</b>	MBA-WZ5 <sup>2)</sup>	6/8 mm	

<sup>1)</sup> For contacts with screw connection with external thread.

<sup>2)</sup> For contacts with screw connection with internal thread.

# Extraction tools socket/pin

Extraction tool (socket)	Order No.	Type	For nominal-Ø pin/socket	For contact
	<b>33.3002</b>	CT-A-WZ0,6	0.6 mm	
	<b>18.3001</b>	MBA-WZ1/1,2	1 mm	
	<b>18.3004</b>	MBA-WZ1,5	1.5 mm	Thermocouple contacts
	<b>33.3027</b>	CT-AWZ-B3/4	3/4 mm	
	<b>18.3017</b>	MBA-WZ6	6/8 mm	
	<b>18.3015</b>	MSA-WZ5		Coaxial contacts
	<b>33.3022</b>	CT-AWZ/POF <sup>1)</sup>		POF contacts
	<b>33.3048</b>	CT-NET-AWZ		CT-NET contacts
	<b>33.3006</b>	CT-AWZ-2,5HV		

Extraction tool (pin)	Order No.	Type	For nominal-Ø pin/socket	For contact
	<b>33.3002</b>	CT-A-WZ0,6	0.6 mm	
	<b>18.3002</b>	MSA-WZ1/1,2	1 mm	
	<b>18.3005</b>	MSA-WZ1,5	1.5 mm	Thermocouple contacts
	<b>33.3028</b>	CT-AWZ-S3/4	3/4 mm	
	<b>18.3018</b>	MSA-WZ6	6 mm	CT-POF/SL
	<b>18.3022</b>	MSA-WZ8	8 mm	Coaxial contacts
	<b>33.3006</b>	CT-AWZ-2,5HV		

<sup>1)</sup> Extraction tool for pin and socket.

# Torque wrench<sup>1)</sup>



Description	Used for	Key size		Tightening torque	
		Ø 8 mm	Ø 6 mm	Ø 8 mm (M6)	Ø 6 mm (M5)
Torque wrench for hex. socket head screw	Fitting cable lug on Ø 8 and 6 mm contacts	5 mm	4 mm	3 N m <sup>2)</sup> 8.5 N m <sup>3)</sup>	2 N m <sup>2)</sup> 5 N m <sup>3)</sup>
Insert for cross recessed screws	Cross recessed screws for supporting rail			0.5 N m	



Description	Used for	Key size		Tightening torque	
		Ø 8 mm	Ø 6 mm	Ø 8 mm (M6)	Ø 6 mm (M5)
Torque wrench	Fitting cable lug	10 mm	8 mm	3 N m <sup>2)</sup> 8.5 N m <sup>3)</sup>	2 N m <sup>2)</sup> 5 N m <sup>3)</sup>
Open-end spanner <sup>1)</sup>	Fitting cable lug	8 mm	7 mm		

# Special tool

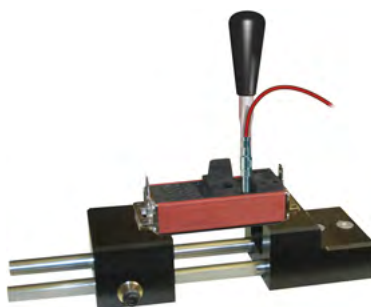
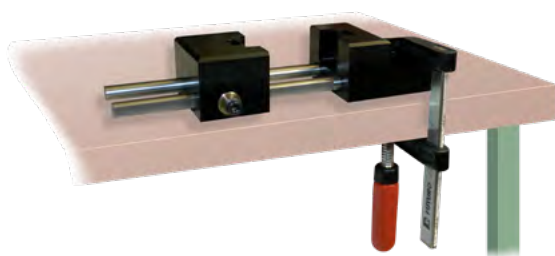

Description	Used for
Special tool CT-K-WZ 33.3040	For easy insertion of the contacts into the contact carrier. Adjustable fixing of the CombiTac units for frame sizes from 18 – 120 mm. It can be fixed on the table with a bar clamp or screws. With anti-slide surface on the underside.
Insert CT-K-WZ-AFL 33.3042	Inserting sockets into the CT-E8-2-IP2X (33.4139) contact carrier with the CT-K-WZ special tool.

<sup>1)</sup> Parts available commercially.

<sup>2)</sup> For internal and external thread.

<sup>3)</sup> Only for steel screws.

APPENDIX

# Derating diagrams

**Derating with the use of cables**

The derating diagrams for cables are based on the standards IEC 60364-5-52:2009 and IEC 60512-5-2:2002. The diagrams show examples of the rated current in correlation with changes in the ambient temperature. If a CombiTac is used to equip machines, standard IEC 60204-1 is applicable instead of IEC 60364-5-52:2009.

**Derating with the use of CombiTac in machines**

In this case, the standard IEC 60204-1 “Safety of Machines” is applicable. This specifies the permitted current load of PVC-insulated copper wire and cables under continuous current when used in machines, at an ambient temperature of 40 °C. For bundled wires and cables under these conditions, additional reduction factors apply.

**Note:**

The corresponding derating current values are only for cables. The total derating current for the connector might differ from these values. When combining different module types or different cable cross sections further reductions are to be considered. A derating factor of 0.9 is already applied to the values in the diagrams.

**Fork connector unit:**

Derating curves for 1 and 2 bundled circuits (2 and 4 bundled wires), using wires with 240 mm<sup>2</sup> cross section.

The maximum permissible conductor surface temperature of the wires used is 125 °C. The curves were calculated according to IEC 60364-5-52:2009 table B.52.17.

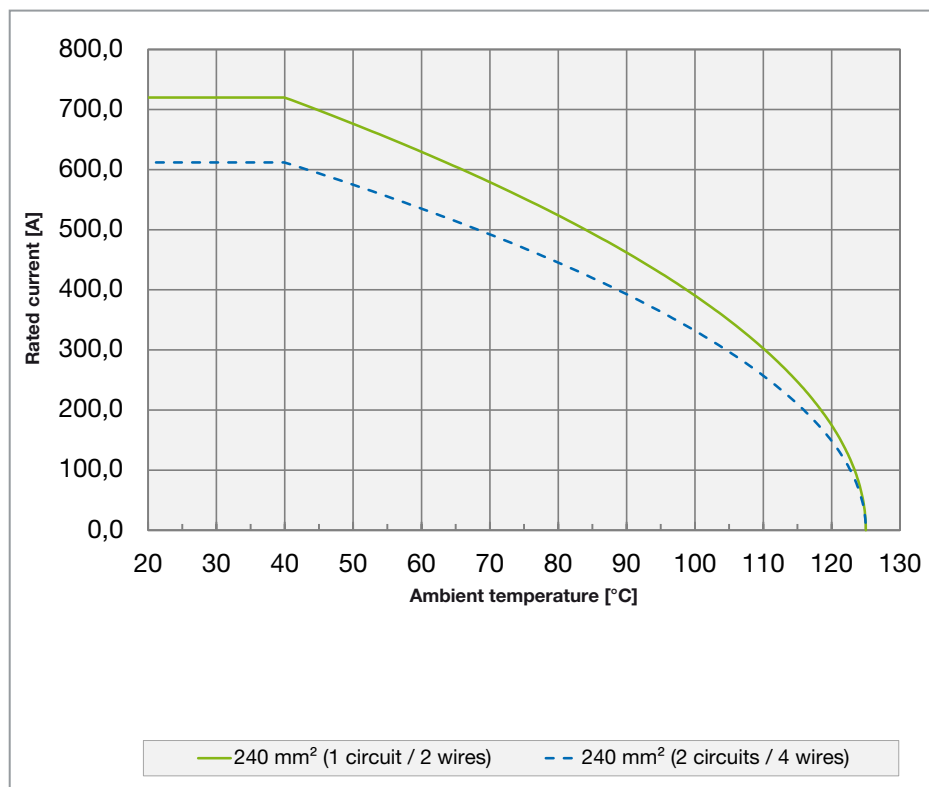

**Ø 12 mm power unit with HTC wires:**

Derating curves for 1, 2 and 3 bundled circuits (2, 4 and 6 bundled wires), using wires with 120 mm<sup>2</sup> cross section and higher thermal conductivity insulation (HTC) for which the maximum permissible conductor surface temperature of the wires used is 125 °C.

The curves were calculated according to IEC 60364-5-52:2009 table B.52.17.

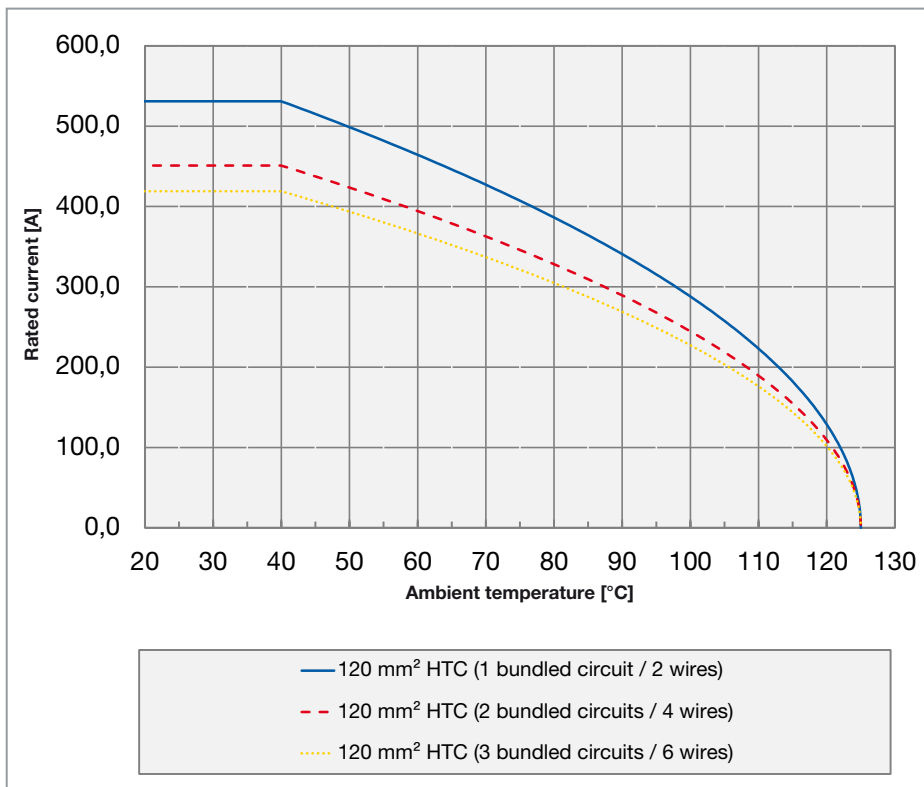

**Ø 12 mm power unit at 125°C:**

Derating curves for 1 and 2 bundled circuits (2 and 4 bundled wires), each with the cross sections 50 mm<sup>2</sup>, 70 mm<sup>2</sup>, 95 mm<sup>2</sup> and 120 mm<sup>2</sup>, for which the maximum permissible conductor surface temperature of the wires used is 125 °C.

The curves were calculated according to IEC 60364-5-52:2009 table B.52.17.

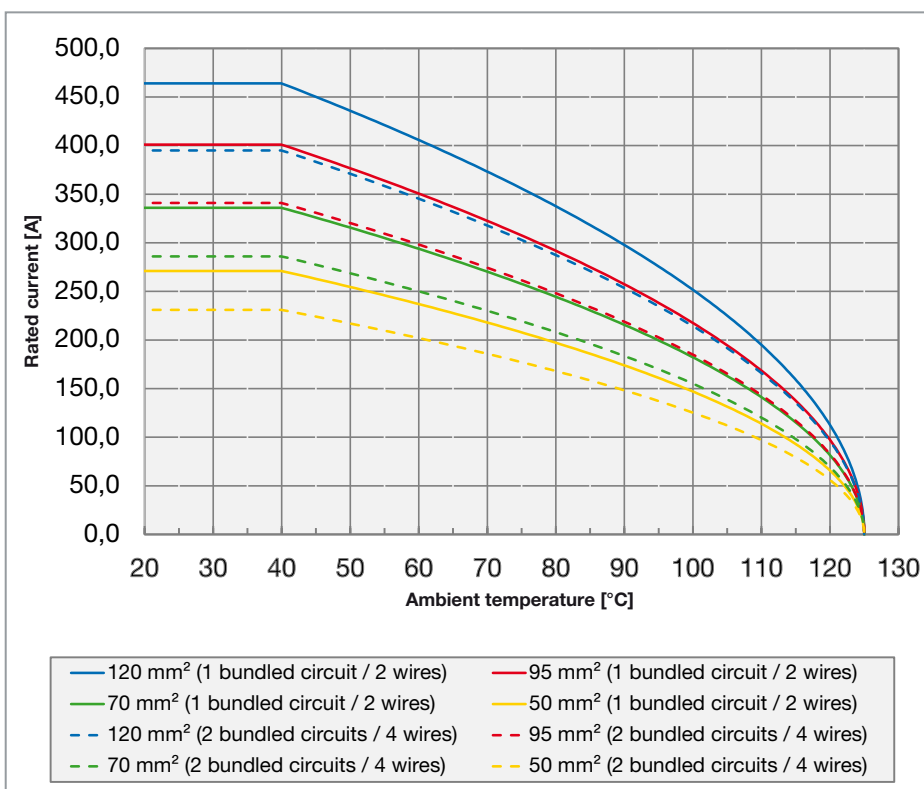

**Ø 12 mm power unit at 90°C:**

Derating curves for 1 and 2 bundled circuits (2 and 4 bundled wires), each with the cross sections 50 mm<sup>2</sup>, 70 mm<sup>2</sup>, 95 mm<sup>2</sup> and 120 mm<sup>2</sup>, for which the maximum permissible conductor surface temperature of the wires used is 90 °C.

The curves were calculated according to IEC 60364-5-52:2009 table B.52.17.

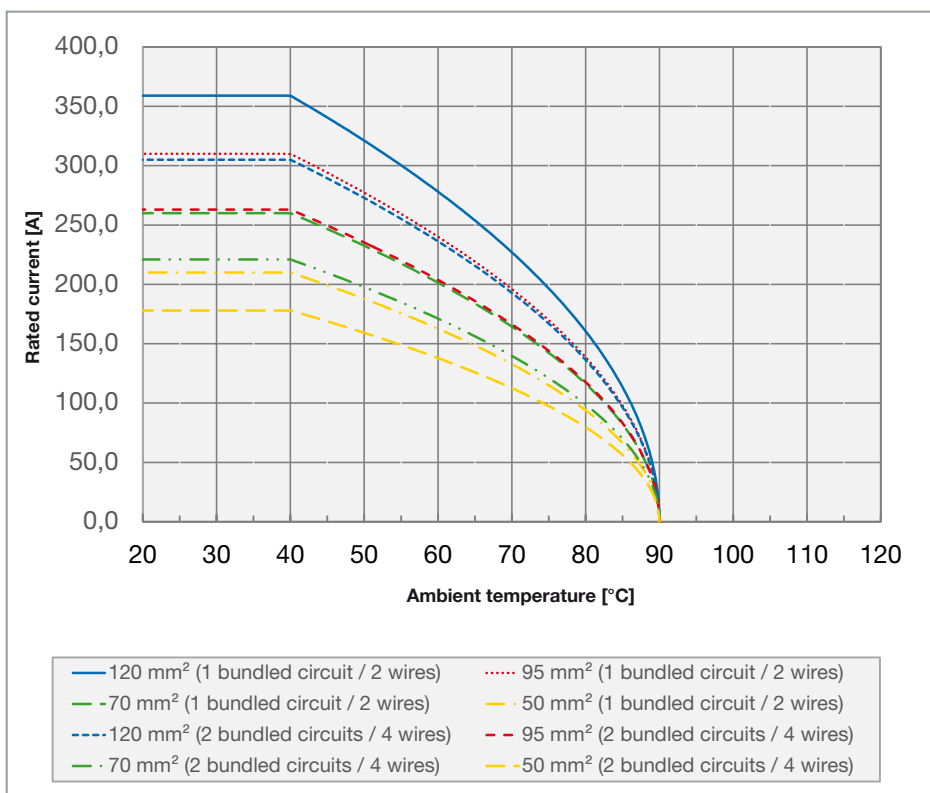

**Ø 8 mm power unit:**

Derating curves for 1 and 2 bundled circuits (2 and 4 bundled wires), each with the cross sections 10 mm<sup>2</sup>, 16 mm<sup>2</sup>, 25 mm<sup>2</sup> and 35 mm<sup>2</sup>. The maximum permissible conductor surface temperature of the wires used is 90 °C.

The curves were calculated according to IEC 60364-5-52:2009 table B.52.17.

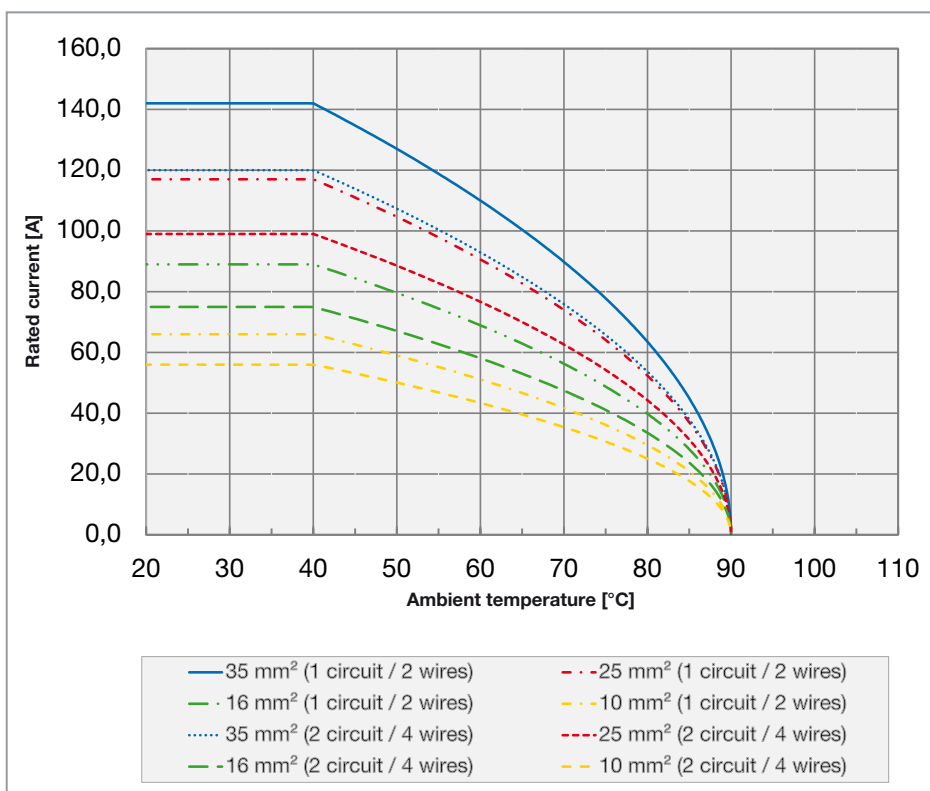

**Ø 6 mm power unit:**

Derating curves for 1 and 2 bundled circuits (2 and 4 bundled wires), each with the cross sections 6 mm<sup>2</sup>, 10 mm<sup>2</sup>, 16 mm<sup>2</sup> and 25 mm<sup>2</sup>. The maximum permissible conductor surface temperature of the wires used is 90 °C.

The curves were calculated according to IEC 60364-5-52:2009 table B.52.17.

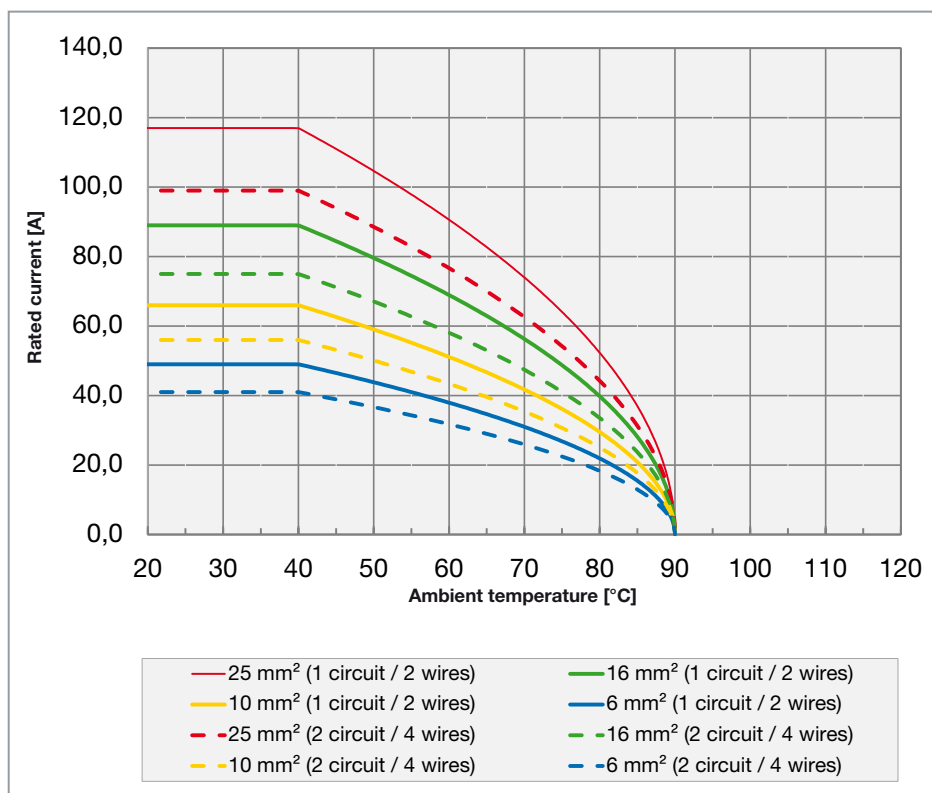

**Ø 4 mm high voltage unit:**

Derating curves for 1 and 2 bundled circuits (2 and 4 bundled wires), each with the cross sections 4 mm<sup>2</sup>, 6 mm<sup>2</sup> and 10 mm<sup>2</sup>. The maximum permissible conductor surface temperature of the wires used is 125 °C.

The curves were calculated according to IEC 60364-5-52:2009 table B.52.17.

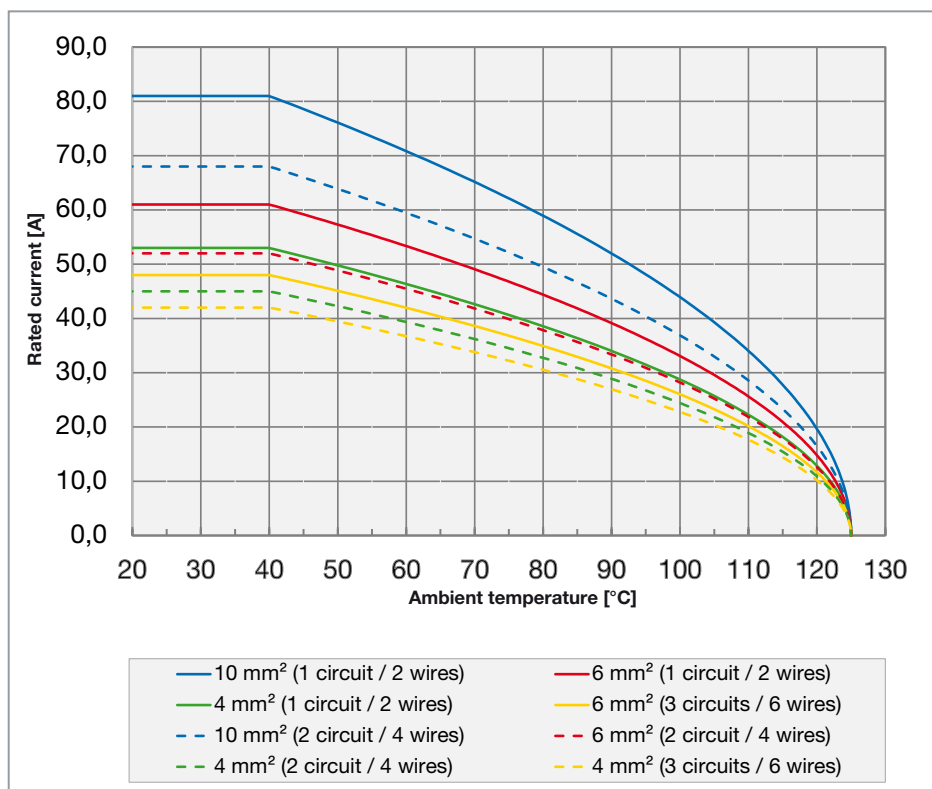

**Ø 3 mm power unit:**

Derating curves for 1, 2 and 3 bundled circuits (2, 4 and 6 bundled wires), each with the cross sections 2.5 mm<sup>2</sup> and 4 mm<sup>2</sup>.

The maximum permissible conductor surface temperature of the wires used is 90 °C. The curves were calculated according to IEC 60364-5-52:2009 table B.52.17.

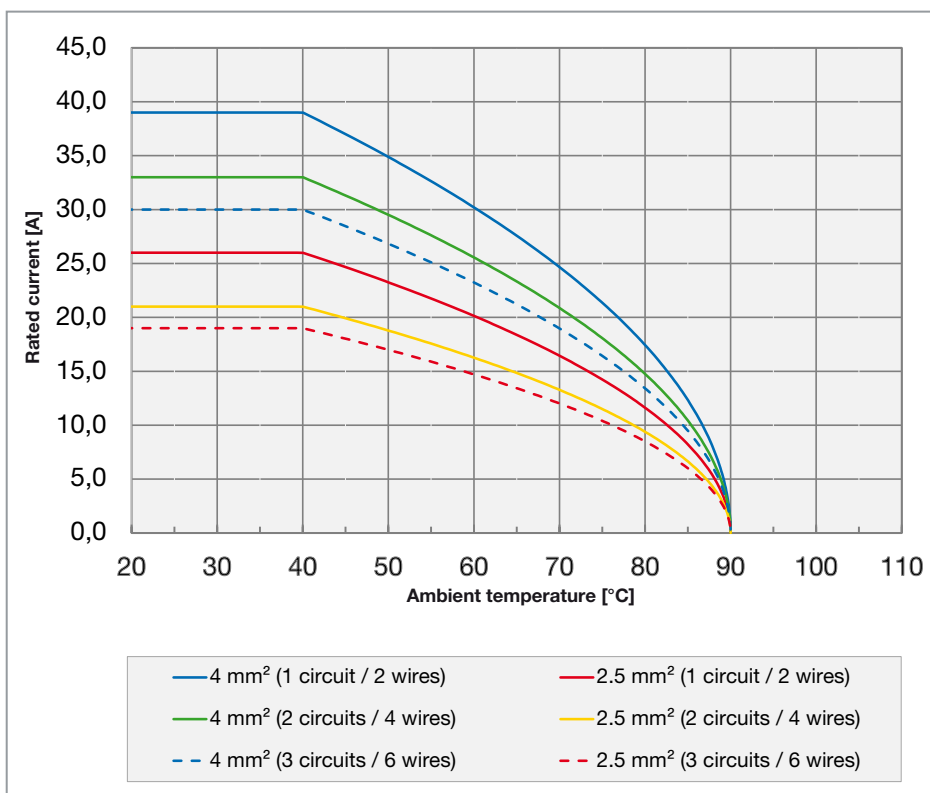

**Ø 1.5 mm high voltage unit:**

Derating curves for 1 and 2 bundled circuits each with the cross sections 0.5 mm<sup>2</sup>, 0.75 mm<sup>2</sup>, 1 mm<sup>2</sup>, and 1.5 mm<sup>2</sup>. The maximum permissible conductor surface temperature of the wires used is 125 °C.

The curves were calculated according to IEC 60364-5-52:2009 table B.52.17.

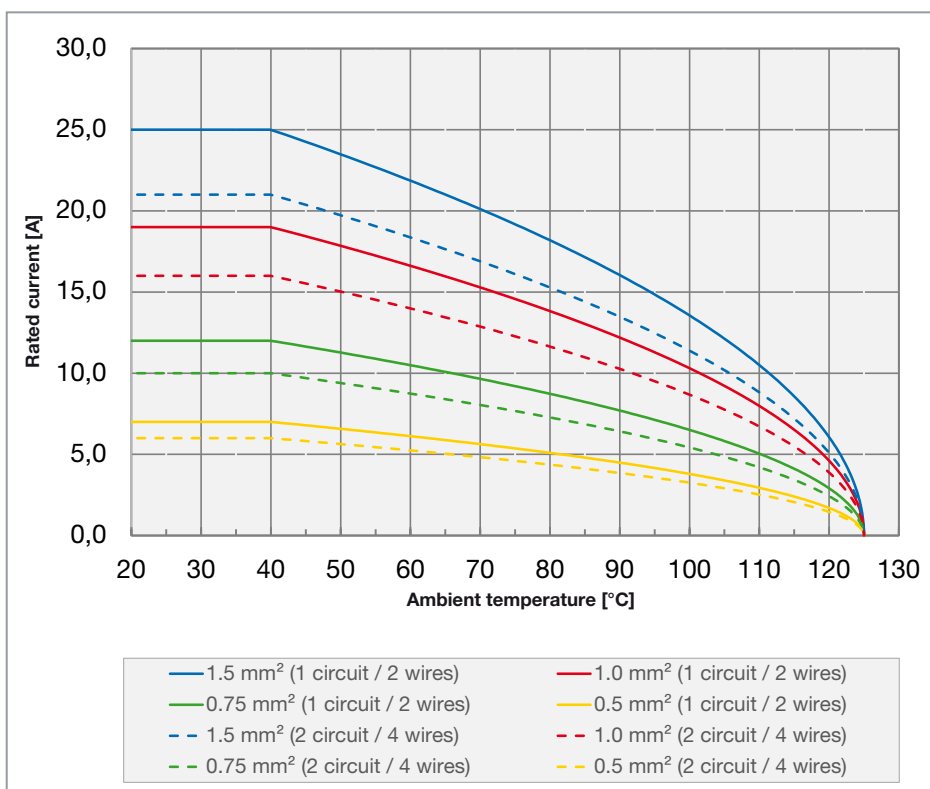

**Ø 1.5 mm signal unit:**

Derating curves for 1 and 2 bundled circuits (2 and 4 bundled wires), each with the cross sections 1.5 mm<sup>2</sup>, 1 mm<sup>2</sup>, 0.75 mm<sup>2</sup> and 0.5 mm<sup>2</sup>.

The maximum permissible conductor surface temperature of the wires used is 90 °C. The curves were calculated according to IEC 60364-5-52:2009 table B.52.17.

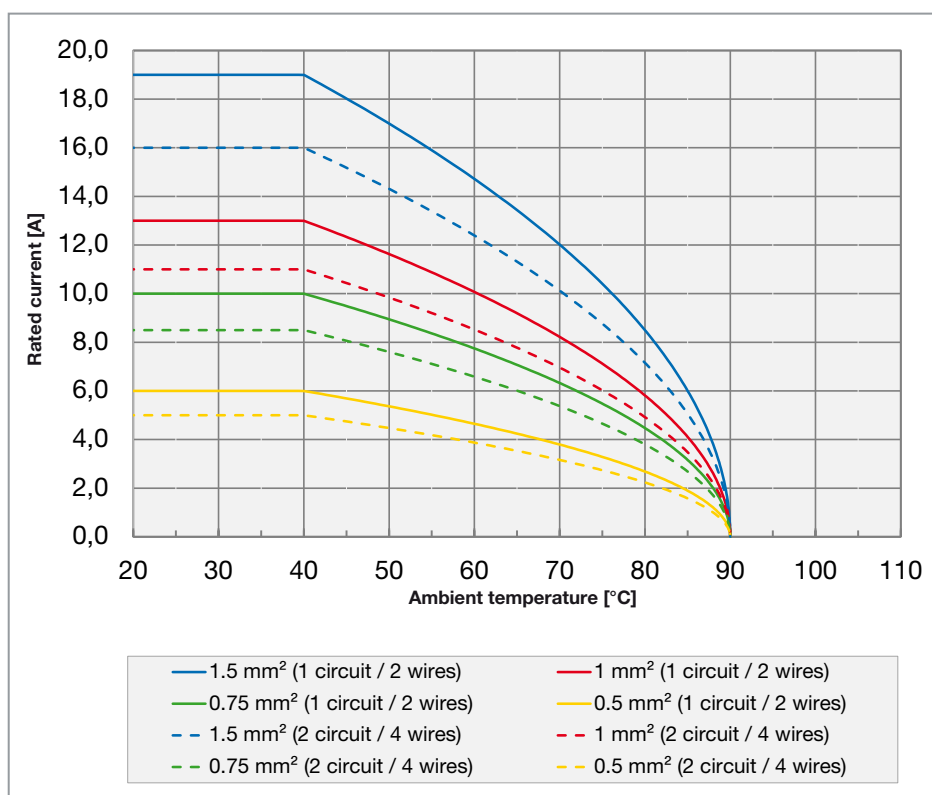

**Ø 1 mm signal unit:**

Derating curves for 1, 2 and 6 bundled circuits (2, 4 and 12 bundled wires), each with the cross sections 0.75 mm<sup>2</sup>, 0.5 mm<sup>2</sup> and 0.25 mm<sup>2</sup>.

The maximum permissible conductor surface temperature of the wires used is 90 °C. The curves were calculated according to IEC 60364-5-52:2009 table B.52.17.

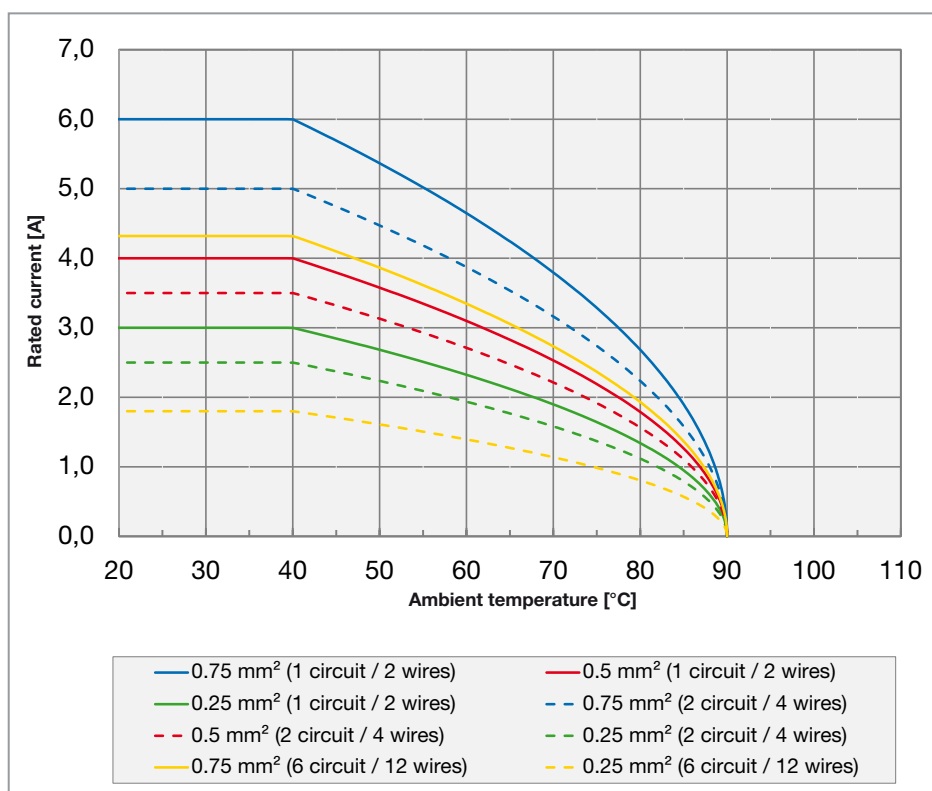

# Technical information

## Sliding forces

The average sliding force of a CombiTac connector is the sum of all average sliding forces of the single contacts. The stated values are guideline values, and may be reduced by 30 % after a number of mating cycles.

## Locking cycles DIN housing

Max. 500 locking cycles without lubrication. For up to 5,000 locking cycles, a lubrication must be executed. See note about lubrication, assembly instructions MA213.

## Mating speed

CombiTac was tested at a mating speed of 600 mm/min by an automatic process. Plugging force is equal to 1.5 times the sliding force.

## Rated current (IEC 61984:2008)

The rated current is a value specified by Stäubli for a current that the connector can carry continuously at an ambient temperature of 40 °C without interruption. It flows simultaneously through all contacts that are connected to the largest possible specified conductors without exceeding the upper limiting temperature of the contacts.

## Bundled wires (IEC 60364-5-52:2009)

If the CombiTac is used together with bundled wires, a reduction factor must be applied to the wires. The derating diagrams on pages 129 – 134 show various examples for bundled copper wires with different cross sections that are suitable for use with CombiTac.

A conversion factor according to IEC 60364-5-52:2009, table B52.17 must be used for a certain number of bundled wires or wire types.

## Rated voltage (IEC 60664-1:2020)

The rated voltage is a voltage value specified by Stäubli for connectors to which the operating and performance characteristics are related. Note: Connectors may have more than one rated voltage value.

The rated voltages listed below correlate normatively with the following impulse withstand voltages. This is subject to the overvoltage category to be met.

## Overvoltage categories

The concept of overvoltage categories is used for equipment energized directly from the low-voltage mains.

**CAT I:** Equipment with an impulse withstand voltage corresponding to overvoltage category I shall not have direct connection to a mains supply.

Measures shall be taken to ensure that the temporary overvoltages that could occur are sufficiently limited so that their peak value does not exceed the relevant rated impulse voltage.

Unless the circuits are designed to take the temporary overvoltages into account, equipment of overvoltage category I cannot be directly connected to the mains supply. Examples of such equipment are devices with electronic circuits and corresponding protection level.

**CAT II:** Equipment of the overvoltage category II is energy consuming equipment to be supplied from the fixed installation.

Examples of such equipment are appliances, portable tools, and other household and similar loads.

IEC 60664-1:2020			IEC 61984:2008	
Rated voltage	Impulse withstand voltage		Test voltage: r.m.s withstand voltage 1 min, 50/60 Hz	
	Overvoltage category II	Overvoltage category III	Overvoltage category II	Overvoltage category III
< 51 V	500 V	800 V	370 V	500 V
51 V – 100 V	800 V	1500 V	500 V	840 V
101 V – 150 V	1500 V	2500 V	840 V	1390 V
151 V – 300 V	2500 V	4000 V	1390 V	2210 V
301 V – 600 V	4000 V	6000 V	2210 V	3310 V
601 V – 1000 V	6000 V	8000 V	3310 V	4260 V

**CAT III:** Equipment of overvoltage category III is equipment in fixed installations and for cases where the reliability and the availability of the equipment is subject to special requirements.

Examples of such equipment are switches in the fixed installation and equipment for industrial use with a permanent connection to the fixed installation.

**Protective conductor PE (IEC 61140:2016)**

The protective conductor is used for safety, for example as protection against electric shock, and can be recognized by letters PE, or color combination green-yellow, or graphical symbol on the potential equalization clamp. The CombiTac has the grounding connection in the frame and various protective earth (PE) contacts. Connect these to the protective-equipotential-bonding system of the installation.

**Pollution degree (IEC 60664-1:2020)**

**Pollution degree 1**

No pollution or only dry, non-conductive pollution occurs. The pollution has no influence.

**Pollution degree 2**

Only non-conductive pollution occurs except that occasionally a temporary conductivity caused by condensation is to be expected.

**Pollution degree 3**

Conductive pollution occurs or dry non-conductive pollution occurs which becomes conductive due to condensation which is to be expected.

**Connector resistance**

The connector resistance is determined by means of the voltage drop, measured between the lead terminations of the pin and socket. The values given are average values determined at rated current.

**Mating cycles**

The maximum number of mating cycles per module is noted in the product catalog. The contacts are lubricated on delivery. In cases where relubrication is possible, it is carried out in accordance with the relevant assembly instructions (MA). Mating cycle tests with CombiTac connectors are carried out under laboratory conditions.

# Safety notes

## Protection against electric shock

A connector shall be so designed that, after mounting, its live parts are not accessible by the IEC test finger in accordance with clause 5 of IEC 60529:2013 using a test force of 20 N. These products are designed to be built into a housing that guarantees the relevant IP protection for cable connections (at least IP2X). Protection against electric shock must be provided by the end product and ensured by the users themselves. This requirement does not apply to a connector operated with a safety extra-low voltage (SELV) of a maximum AC 50 V eff. or DC 120 V. The customer must take appropriate measures when fitting the connectors to ensure that the cable connection is protected against tension and twisting and is responsible for correct implementation of the contact-protection measures.

Connecting and disconnecting when live is permitted.

Connecting and disconnecting under load is not permitted.

## Enclosure

An enclosed connector is a connector for which the protection against electric shock is ensured by the housing of the connector itself. An unenclosed connector is a connector for which the protection against electric shock is provided by the enclosure of the equipment in which the connector is mounted.

In relation to the direction of power flow, connectors should be incorporated in the circuit wiring in such a way that pins that can be touched are not live in the unmated state (IEC 61984:2008).

## Protection wall

In order to meet the requirement for protection against accessibility of live parts during connecting and disconnecting, CombiTac is provided with a specially designed protection wall.

## Electrical contacts in close proximity to connectors for liquids and gases

Defect electrical contacts or connectors that leak gas or liquids can be a safety hazard to personnel, the environment, as well as affecting the proper function of the system. It is the responsibility of the end-user to ensure that both safety and proper function in the end-use is guaranteed. The result of a risk analysis requires that the end-user of CombiTac connectors must ensure the following:

- All relevant national and international standards and regulations must be complied with in the end-use.
- Field-tested techniques must be applied and, a risk assessment must be carried out in order to identify and reduce the risks.
- The use of flammable or explosive liquids or gases is prohibited.
- Exclusively CT-...SCT; CT-...-LCT couplings with both male and female-sided locking systems are permitted to be used for liquids.
- Automatic disconnection of power supply in the event of indirect contact, overload, or short circuit is required according to IEC 60364-4-41:2017.
- If the voltage is higher than AC 50 V or DC 120 V, all simultaneously accessible conductive parts that do not carry current during normal operation must be connected to the protective conductor (protective equipotential bonding according to IEC 60364-4-41:2017).
- If the voltage is higher than AC 50 V or DC 120 V, all electric circuits have to be protected by a residual-current-operated protective device (RCD) with a rated residual operating current not exceeding 30 mA according to IEC 60364-4-41:2017.
- Connecting or disconnecting under load or live is not allowed (connector without breaking capacity according to IEC 61984:2008).

- On permanently fixed installations, electrical contacts have to be placed above liquid couplings.
- In CombiTac housing applications, the housing has to be connected to the protective conductor according to IEC 60364-4-41:2017.
- The fluid couplings must be replaced if a leak is detected.

## Underwriters Laboratories

### Standard UL 1977 states:

A connector operated above 30 V (42 V peak) up to AC/DC 600 V intended for usage external to the end equipment shall have live parts protected against exposure to contact by persons when assembled, installed, and mated as intended, as determined by the use of the articulate probe with web stop (UL test finger).

Mating devices operated above 30 V up to AC/DC 600 V intended for usage external to the end equipment shall not have exposed live contacts during engagement or withdrawal, as determined by the use of the articulate probe with web stop (UL test finger).

**Engineering considerations according to UL File E229145**

File E229145, Vol. 1, Sec. 4

**ENGINEERING CONSIDERATIONS:**

**Use** For use only in complete equipment where the acceptability of the combination is determined by Underwriters Laboratories Inc.

**Conditions of Acceptability** In order to be judged acceptable as a component of electrical equipment, the following conditions should be met. These devices have not been tested for interrupting the flow of current by connecting or disconnecting the mating connector. These devices should be used only where they will not interrupt the flow of current.

These devices have been subjected to the temperature test within the provided housings with the rated currents. The conductors terminated by the device and other associated components are to be reviewed in the end use to determine whether the temperature rise from the connector exceeds their maximum operating temperature ratings.

**Fork Connector**

Contact size	Wire size	Current rating
Ø mm	AWG	(A)
12	3/0	300
12	2/0	245
12	1/0	200
8	2	150 <sup>1)</sup>
8	2	120 <sup>2)</sup>
8	2	100 <sup>3)</sup>
8	4	75
8	6	55
6	4	100
6	4	75
6	6	55
6	8	40

Contact size	Wire size	Current rating
Ø mm	AWG	(A)
3	12	24.5
3	14	22
3	10	35
3 (HV) <sup>4)</sup>	14	32
3 (HV) <sup>5)</sup>	14	20
1.5	16	10
1.5	18	5
1.5	20	3
1.5 (HV)	16	14
1.5 (HV)	18	10
1	18	5
1	20	3

Contact size	Wire size	Current rating
mm	MCM	(A)
42 mm x 5 mm	430	600

These devices, except otherwise documented in this Report may be used at potentials not exceeding 600 V based on dielectric voltage-withstand testing conducted between adjacent poles and between live parts and dead metal at 2,200 V ac. These devices meet the minimum 1/8 inch (3.2 mm) spacings required by UL 1977 for devices not exceeding 600 V.

The operating temperature of these devices should not exceed the temperature ratings of the insulating materials. These materials may be used interchangeably at a maximum temperature of 90 °C. Mold stress relief testing was conducted at a temperature of 100 °C.

The acceptability of the quick-connect tab as a grounding terminal shall be determined in the end use.

The printed-wiring-board terminals have not been evaluated for mechanical secureness. The construction of the connector is to be reviewed when it is assembled to the particular printed wiring board used in the end use application.

The strain relief device on the housing of the connectors has not been evaluated. This construction shall be determined in the end use.

<sup>1)</sup> Only one contact per carrier  
<sup>2)</sup> Wire size 35 mm<sup>2</sup>  
<sup>3)</sup> Wire size 25 mm<sup>2</sup>  
<sup>4)</sup> One pole carrier  
<sup>5)</sup> Two pole carrier

# Safety during the mating process

Connecting and disconnecting when CombiTac is isolated from supply.

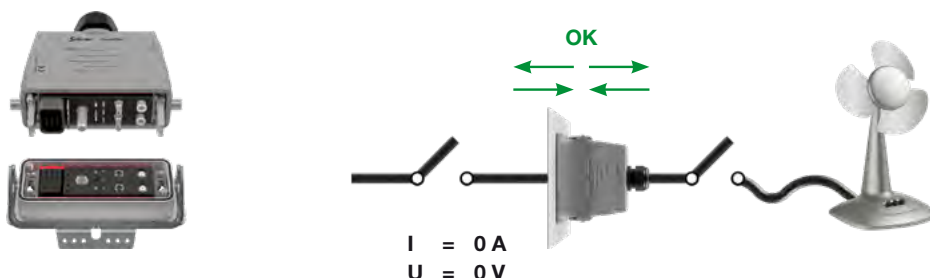

Connecting and disconnecting when live and without load is permitted.

**⚠ Attention**

When disconnected, the socket side is touch protected, i.e. has IP2X protection according to IEC 60529 (test finger)

See also page 137, section “Underwriters Laboratories standard UL 1977”.

With protection wall

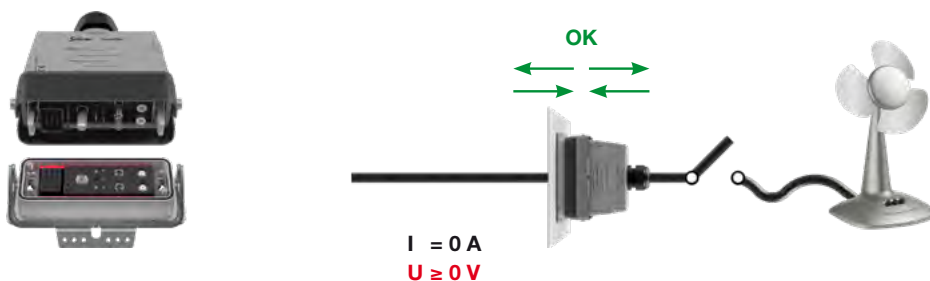

Connecting and disconnecting under load not permitted.

With or without protection wall

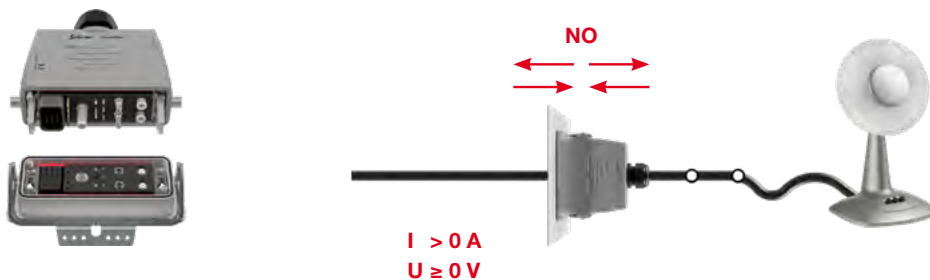

## Panel mounting

The protection against electric shock is provided by the enclosure of the equipment in which it is installed. This is provided by the CombiTac end-user.



# Applications

CombiTac in an automated radio testing station for the automotive industry.  
The connector solution consists of signal, coaxial and fiber optic contacts.

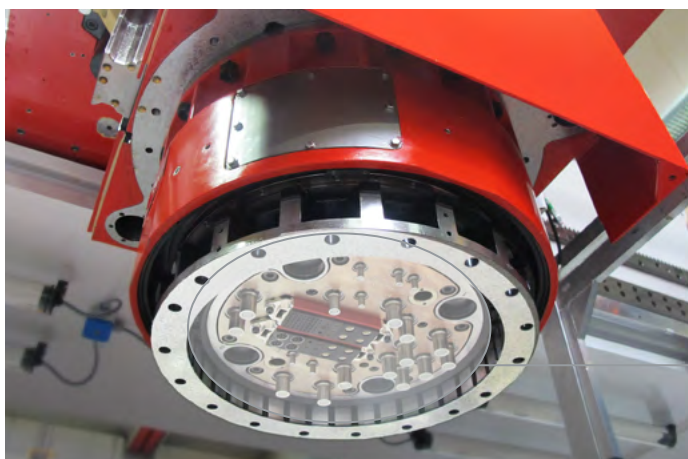
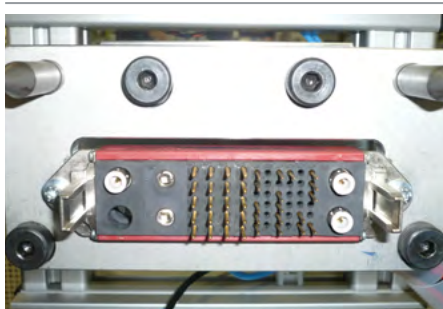

Connector solution with CombiTac for plate mounting, to create a connection between the various milling head units and the drive.

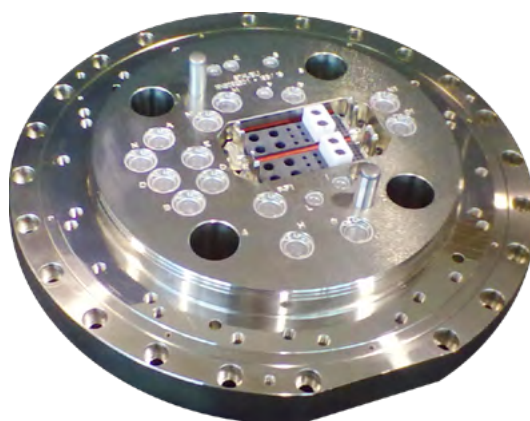



CombiTac in a modular test bench for the testing and simulation of electric components.



CombiTac for connections to mobile trolleys in operation rooms for medical technology.

# CombiTac in multi coupling solutions

The multi coupling principle allows you to centralize your different connections (power, signal, pneumatics, hydraulics, etc.) and get instant energy thanks to a much easier and reliable coupling procedure.

Such automatic or manually operated quick disconnect systems allow standard components to be mounted onto carrier plates and several energies to be connected or disconnected simultaneously.

Multi coupling plates are commonly used in high-performance applications that demand reliability and repeatability, such as connections for test benches, injection moulding tools, transfer tables, and converters, etc.



Multi coupling plates: the optimal combination of  
high-performance solutions

UNLIMITED POSSIBILITIES FOR CONTACT SOLUTIONS

MULTILAM Technology



**MULTILAM** are specially formed and resilient contact elements. All Stäubli Electrical Connectors products benefit from the unique and outstanding performance of the MULTILAM Technology.

Thanks to their constant spring pressure, MULTILAM louvers ensure continuous contact with the contact surface, resulting in a constantly low contact resistance.

MULTILAM Technology allows to find solutions for connectors within the severest constraints and in certain products for up to 1 million mating cycles.

This makes the MULTILAM Technology the best choice for applications with demanding requirements:

- Reliable and longlife operation due to constantly high performance
- Safe operation under highest environmental demands on temperature, vibration and shock
- Particularly suitable for high current connectors, but also for data and signal contacts as well as for high voltage connections
- Automated solutions with a high number of mating cycles

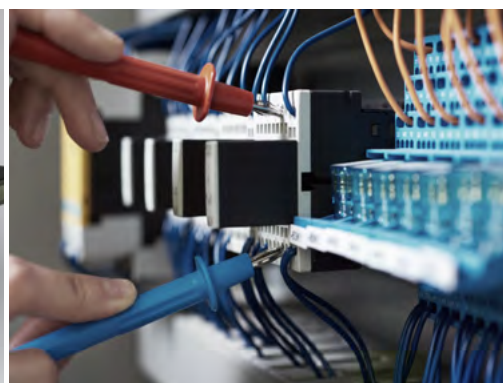



# Index

Type	Page
CT-10GBIT-M12/B	49
CT-10GBIT-M12/S	49
CT-10GBIT-RJ45/B	49
CT-10GBIT-RJ45/S	49
CT-AG1 IP68 HE	108
CT-AG1 TP	114
CT-AG1TP PS/B	116
CT-AG1TP PS/S	116
CT-AG2 IP68 HE	108
CT-AG2 TP	114
CT-AG2TP PS/B	116
CT-AG2TP PS/S	116
CT-AG3 IP68 HE	108
CT-AG3 TP	114
CT-AG3TP PS/B	116
CT-AG3TP PS/S	116
CT-AG4 IP68 HE	108
CT-AG4 TP	114
CT-AG4TP PS/B	116
CT-AG4TP PS/S	116
CT-AIWZ/COAX	125
CT-AIWZ/POF	125
CT-A-WZ0,6	127
CT-AWZ-2,5HV	127
CT-AWZ-B3/4	127
CT-AWZ/POF	127
CT-AWZ-S3/4	127
CT-B0,6ET/LO AU	39
CT-B0,6ET/PCB AU	39
CT-B1,5LAV/PCB AU	33
CT-B1ET/PCB AU	37
CT-B1/PCB AU	37
CT-B3/PCB-K AU	27
CT-B6/M5A AG	23
CT-B6/M5 AG	23
CT-B6/M5A/PE AG	21
CT-B8/M6A AG	17
CT-B8/M6A AU	17
CT-B8/M6 AG	17
CT-B8/M6A/PE AG	21
CT-B8/M6 AU	17
CT-B8/M8A/PE-L AG	20
CT-B12/M10 AG	14
CT-B/COAX58	45

Type	Page
CT-B/COAX59	45
CT-B-COAX-RG58	43
CT-B-COAX-RG316/U	43
CT-B-COAX-SMA	43
CT-BE-B	82
CT-BEG-B	82, 119
CT-BEG-S	82, 119
CT-BE-S	82
CT-BESZ-B	82
CT-BESZ-S	82
CT-B/GOF	55
CT-B/GOF-025-FSMA	55
CT-B/GOF-100-SC	55
CT-B/GOF-100-ST	55
CT-B-GSR5/600A AG	11
CT-B-LCT06	75
CT-BP0,6ET/0,14-0,25 AU	39
CT-BP1/0,25-0,75 AU	37
CT-BP1,5/0,5-1,5-HV	31
CT-BP1,5LAV/0,5-1,5 AU	33, 59
CT-BP1,5LAV/1,5 AU	33
CT-BP1ET/0,25-0,75 AU	37
CT-BP3/2,5-4 AU	27, 29
CT-BP3/2,5-4/PE AU	29
CT-BP4/2,5-4-HV AU	25
CT-BP4/6-HV AU	25
CT-BP4/10-HV AU	25
CT-BP6/6 AG	23
CT-BP6/10 AG	23
CT-BP6/16 AG	23
CT-BP6/16/PE AG	21
CT-BP8/10 AG	17
CT-BP8/10 AU	17
CT-BP8/16 AG	17
CT-BP8/16 AU	17
CT-BP8/25 AG	17
CT-BP8/25 AU	17
CT-BP8/25/PE AG	21
CT-BP8/25/PE-L AG	19
CT-BP8/35 AG	17
CT-BP8/35/PE-L AG	19
CT-BP8/50/PE-L AG	19
CT-BP10/10/PE-GND AG	121
CT-BP10/16/PE-GND AG	121

Type	Page
CT-BP10/25/PE-GND AG	121
CT-BP10/35/PE-GND AG	121
CT-BP10/50/PE-GND AG	121
CT-BP10/AWG4/PE-GND AG	121
CT-BP12/50 AG	13
CT-BP12/70 AG	13
CT-BP12/95 AG	13
CT-BP12/120 AG	13
CT-B/POF	53
CT-B-RCT03/1/4"	63
CT-B-RCT03/4	63
CT-B-RCT03/6	63
CT-B-RCT03/PLV 2/4	63
CT-B-RCT03/PLV4/6	63
CT-BS	82
CT-BS1	37
CT-BS8	17, 45
CT-BS-AL	82
CT-B-SCT03	73
CT-BSGOF	41, 55
CT-BTG-B	82
CT-BTG-S	82
CT-B-UCT04/1/4"	63
CT-B-UCT04/6	63
CT-B-UCT06/8	65
CT-B-UCT08/3/8"	67
CT-B-UCT08/10	67
CT-BV-RCT03/1/4"	63
CT-BV-RCT03/4	63
CT-BV-RCT03/6	63
CT-BV-RCT03/PLV 2/4	63
CT-BV-RCT03/PLV4/6	63
CT-BV-RCT06/8	67
CT-BV-RCT06/PLV6/8	67
CT-BV-RCT06/PLV8/10	67
CT-CH1-S	92
CT-CH1-T	92
CT-CH2-S	92
CT-CH2-S/PW	95
CT-CH2-S/PW-PC	95
CT-CH2-S/SSL	104
CT-CH2-T	92
CT-CH2-T/PW	95
CT-CH2-T/PW-PC	95

Type	Page
CT-CH2-T/SSL	104
CT-CH2/ZV-R	110
CT-CH3-S	92
CT-CH3-S/PW	95
CT-CH3-S/PW-PC	95
CT-CH3-S/SSL	104
CT-CH3-T	92
CT-CH3-T/PW	95
CT-CH3-T/PW-PC	95
CT-CH3-T/SSL	104
CT-CH3/ZV-R	110
CT-CH4-S	92
CT-CH4-S/PW	95
CT-CH4-S/PW-PC	95
CT-CH4-S/SSL	104
CT-CH4-T	92
CT-CH4-T/PW	95
CT-CH4-T/PW-PC	95
CT-CH4-T/SSL	104
CT-CH4/ZV-R	110
CT-CH5-S	92
CT-CH5-S/PW	95
CT-CH5-S/PW-PC	95
CT-CH5-T	92
CT-CH5-T/PW	95
CT-CH5-T/PW-PC	95
CT-CH6-S	92
CT-CH6-S/PW	95
CT-CH6-S/PW-PC	95
CT-CH6-T	92
CT-CH6-T/PW	95
CT-CH6-T/PW-PC	95
CT-CHG1-T	93
CT-CHG2-T	93
CT-CHG2-T/PW	93
CT-CHG3-T	93
CT-CHG3-T/PW	93
CT-CHG4-T	93
CT-CHG4-T/PW	93
CT-CHG5-T	93
CT-CN-GF-TORX	123
CT-CP	125
CT-CZ/COAX	125
CT-CZ/POF	125

Type	Page
CT-DDI-SM2	101, 107
CT-DDI-SM3	101, 107
CT-DDI-SM4	101, 107
CT-DIP0,5	78
CT-DIP1	78
CT-DIP1 K	78
CT-DIP2	78
CT-DIP2/2	10, 78
CT-DIP3	78
CT-DIP4	78
CT-DIP4/2	12, 20, 78
CT-E0,6-20/B	38
CT-E0,6-20/S	38
CT-E1,5-4/HV-B	30
CT-E1,5-4/HV-S	30
CT-E1,5-5	32
CT-E1-6	36
CT-E1-15/B	35
CT-E1-15/S	35
CT-E1-26/B	34
CT-E1-26/S	34
CT-E-2TH+PE/B	58
CT-E-2TH+PE/S	58
CT-E3-2+PE/B	28
CT-E3-2+PE/S	28
CT-E3-3	26
CT-E3-3/B	26
CT-E3-3/PCB	26
CT-E3-3/PCB/B	26
CT-E-3POF/B	52
CT-E-3POF/S	52
CT-E4-2/HV-B	24
CT-E4-2/HV-S	24
CT-E-4GOF	54
CT-E6-2	22, 52
CT-E8-2	16, 44, 62, 72
CT-E8-2-IP2X	16
CT-E8-4/B	62, 72
CT-E8-4/S	62, 72
CT-E8/6-PE	18
CT-E12-1/B	12
CT-E12-1/S	12
CT-E-COAX-1	42
CT-E-COAX-2	42

Type	Page
CT-E-GSR5-1-B UL	10
CT-E-GSR5-1-S UL	10
CT-E-SCT03-2	72
CT-E-UCT06-1	64
CT-E-UCT06-2	64
CT-E-UCT06-4	64
CT-E-UCT08-1	66, 74
CT-E-UCT08-2	66, 74
CT-E-WZ0,6	126
CT-E-WZ1-9,5	126
CT-E-ZV/B/TG2	110
CT-E-ZV/B/TG3	110
CT-E-ZV/B/TG4	110
CT-E-ZV/S	110
CT-GND10 AG	120
CT-HME-B/4	81
CT-HME-S/4	81
CT-HV-SRTU	25
CT-I-CP-4	125
CT-I-CP-6	125
CT-I-CP-10	125
CT-K-VSH M25x9,5-12,5 MS	15
CT-K-VSH M25x10-17 MS	15
CT-K-VSH M25x16-20,5 MS	15
CT-K-VSH M32x17-21 MS	15
CT-K-VSH M32x21-25,5 MS	15
CT-K-WZ	128
CT-K-WZ-AFL	128
CT-LMFB/B	40
CT-LMFB-B2/0,5-1,5 AU	41
CT-LMFB/S	40
CT-LMFB-S2/0,5-1,5 AU	41
CT-M-CZ	124
CT-NET-1/B	46
CT-NET-1/S	46
CT-NET-2/B	46
CT-NET-2/S	46
CT-NET-AWZ	127
CT-NET-BP1 ET/0,14-0,75 AU	47
CT-NET-BS	47
CT-NET-SP1/0,14-0,75 AU	47
CT-PC1 IP68 HE	109
CT-PC2 IP68 HE	109
CT-PC3 IP68 HE	109

Type	Page
CT-PC4 IP68 HE	109
CT-PC-SM1-L/FSCH	102
CT-PC-SM2-L/FSCH	102
CT-PC-SM3-L/FSCH	102
CT-PC-SM4-L/FSCH	102
CT-PC-SM5-L/FSCH	102
CT-PC-SM6-L/FSCH	102
CT-PDI-SM2	101, 107
CT-PDI-SM3	101, 107
CT-PDI-SM4	101, 107
CT-PM1	99
CT-PM1-PC	99
CT-PM2	99
CT-PM2-PC	99
CT-PM2/PW	99
CT-PM3	99
CT-PM3-PC	99
CT-PM3/PW	99
CT-PM4	99
CT-PM4-PC	99
CT-PM4/PW	99
CT-PM5	99
CT-PM5-PC	99
CT-PM5/PW	99
CT-PM6	99
CT-PM6-PC	99
CT-POF/SL	53
CT-PS1-SM/P	101
CT-PS1-SM/S	101
CT-PS2/PC-SM/S	101
CT-PS2-SM/P	101
CT-PS2-SM/S	101
CT-PS2-SM/SSL/P	106
CT-PS2-SM/SSL/S	106
CT-PS3/PC-SM/S	101
CT-PS3-SM/P	101
CT-PS3-SM/S	101
CT-PS3-SM/SSL/P	106
CT-PS3-SM/SSL/S	106
CT-PS4/PC-SM/S	101
CT-PS4-SM/P	101
CT-PS4-SM/S	101
CT-PS4-SM/SSL/P	106
CT-PS4-SM/SSL/S	106

Type	Page
CT-PS5/PC-SM/S	101
CT-PS5-SM/P	101
CT-PS5-SM/S	101
CT-PS6/PC-SM/S	101
CT-PS6-SM/P	101
CT-PS6-SM/S	101
CT-PS/POF	125
CT-RC12	10, 12
CT-RC-COAX	42
CT-RJ45/B	50
CT-RJ45/S	50
CT-S0,6/LO AU	39
CT-S0,6/PCB AU	39
CT-S1,5/PCB-K AU	33
CT-S1,5/PCB-L AU	33
CT-S1/PCB-K AU	37
CT-S1/PCB-L AU	37
CT-S3/PCB-K AU	27
CT-S3/PCB-L AU	27
CT-S6/M5A AG	23
CT-S6/M5 AG	23
CT-S6/M5A/PE AG	21
CT-S8/M6A AG	17
CT-S8/M6A AU	17
CT-S8/M6 AG	17
CT-S8/M6A/PE AG	21
CT-S8/M6 AU	17
CT-S8/M8A/PE-L AG	20
CT-S12/M10 IP2X AG	14
CT-SC0,8	41
CT-S/COAX58	45
CT-S/COAX59	45
CT-S-COAX-RG58	43
CT-S-COAX-RG316/U	43
CT-S-COAX-SMA	43
CT-SD-AG1 TP	115
CT-SD-AG2 TP	115
CT-SD-AG3 TP	115
CT-SD-AG4 TP	115
CT-SG1 IP68 HE	109
CT-SG1 TP	115
CT-SG2 IP68 HE	109
CT-SG2 TP	115
CT-SG3 IP68 HE	109

Type	Page
CT-SG3 TP	115
CT-SG4 IP68 HE	109
CT-SG4 TP	115
CT-S/GOF	55
CT-S/GOF-030-FSMA	55
CT-S/GOF-100-SC	55
CT-S/GOF-100-ST	55
CT-S-GSR5/600A AG	11
CT-SHR-HS	82
CT-S-LCT06	75
CT-SM1	97
CT-SM1-PC	97
CT-SM2	97
CT-SM2-PC	97
CT-SM2/PW	97
CT-SM2/SSL	105
CT-SM2/ZV	110
CT-SM3	97
CT-SM3-PC	97
CT-SM3/PW	97
CT-SM3/SSL	105
CT-SM3/ZV	110
CT-SM4	97
CT-SM4-PC	97
CT-SM4/PW	97
CT-SM4/SSL	105
CT-SM4/ZV	110
CT-SM5	97
CT-SM5-PC	97
CT-SM5/PW	97
CT-SM6	97
CT-SM6-PC	97
CT-SP0,6/0,14-0,25 AU	39
CT-SP1/0,25-0,75K AU	37
CT-SP1/0,25-0,75L AU	37
CT-SP1,5/0,5-1,5-HV	31
CT-SP1,5/0,5-1,5K AU	33, 59
CT-SP1,5/0,5-1,5L AU	33
CT-SP1,5/1,5K AU	33
CT-SP3/2,5-4K AU	27, 29
CT-SP3/2,5-4L AU	27, 29
CT-SP3/2,5-4/PE AU	29
CT-SP4/2,5-4-HV AU	25
CT-SP4/6-HV AU	25

Type	Page
CT-SP4/10-HV AU	25
CT-SP6/6 AG	23
CT-SP6/10 AG	23
CT-SP6/16 AG	23
CT-SP6/16/PE AG	21
CT-SP8/10 AG	17
CT-SP8/10 AU	17
CT-SP8/16 AG	17
CT-SP8/16 AU	17
CT-SP8/25 AG	17
CT-SP8/25 AU	17
CT-SP8/25/PE AG	21
CT-SP8/25/PE-L AG	19
CT-SP8/35 AG	17
CT-SP8/35/PE-L AG	19
CT-SP8/50/PE-L AG	19
CT-SP10/10/PE-GND AG	121
CT-SP10/16/PE-GND AG	121
CT-SP10/25/PE-GND AG	121
CT-SP10/35/PE-GND AG	121
CT-SP10/50/PE-GND AG	121
CT-SP10/AWG4/PE-GND AG	121
CT-SP12/50 IP2X AG	13
CT-SP12/70 IP2X AG	13
CT-SP12/95 IP2X AG	13
CT-SP12/120 IP2X AG	13
CT-S/POF	53
CT-S-RCT03/¼"	63
CT-S-RCT03/4	63
CT-S-RCT03/6	63
CT-S-RCT03/PLV 2/4	63
CT-S-RCT03/PLV4/6	63
CT-S-RCT06/8	67
CT-S-RCT06/PLV6/8	67
CT-S-RCT06/PLV8/10	67
CT-S-SCT03	73
CT-S-UCT04/¼"	63
CT-S-UCT04/6	63
CT-S-UCT06/8	65
CT-S-UCT08/3/8"	67
CT-S-UCT08/10	67
CT-TG1-G IP68 HE	108
CT-TG1-G TP	114
CT-TG1-S IP68 HE	108

Type	Page
CT-TG1-S TP	114
CT-TG2-G IP68 HE	108
CT-TG2-G TP	114
CT-TG2-S IP68 HE	108
CT-TG2-S TP	114
CT-TG3-G IP68 HE	108
CT-TG3-G TP	114
CT-TG3-S IP68 HE	108
CT-TG3-S TP	114
CT-TG4-G IP68 HE	108
CT-TG4-G TP	114
CT-TG4-S IP68 HE	108
CT-TG4-S TP	114
CT-ZV/B	110
DBP2-AL/0,14-0,5	59
DBP2-CO/0,14-0,5	59
DBP2-CR/0,14-0,5	59
DBP2-CU/0,14-0,5	59
DBP2-FE/0,14-0,5	59
DBP2-NICRSI/0,14-0,5	59
DBP2-NISI/0,14-0,5	59
DSP2-AL/0,14-0,5	59
DSP2-CO/0,14-0,5	59
DSP2-CR/0,14-0,5	59
DSP2-CU/0,14-0,5	59
DSP2-FE/0,14-0,5	59
DSP2-NICRSI/0,14-0,5	59
DSP2-NISI/0,14-0,5	59
F/M8 DIN6798A BN781	20
F/M10 DIN6798A BN781	14
K-SCH25-8	20
K-SCH35-6	17, 21
K-SCH35-8	20
K-SCH50-8	20
K-SCH50-10	14
K-SCH70-10	14
K-SCH95-10	14
LI-BL-SHR	82
LI-SHR-GF	82
MALU-PZ13	124
MBA-WZ1/1,2	127
MBA-WZ1,5	127
MBA-WZ5	126
MBA-WZ6	127

Type	Page
MES-CZ	124
MES-CZ-CT0,6	124
MES-CZ-CT0,6-COAX-RG	124
MES-CZ-CT1	124
MES-CZ-CT1,5	124
MES-CZ-CT1,5-HV	124
MES-CZ-CT3	124
MES-PZ-TB5/6	124
MES-PZ-TB8/10	124
MES-PZ-TB9/16	124
MES-PZ-TB11/25	124
ME-WZ1,5/2	126
ME-WZ3	126
ME-WZ5	126
ME-WZ6	126
MPS-PZ13	124
M-PZ13	124
M-PZ-T2600	124
MSA-WZ1/1,2	127
MSA-WZ1,5	127
MSA-WZ5	126, 127
MSA-WZ6	126, 127
MSA-WZ8	127
MU0,8D/M8 AG	20
MVS1	33
18.5504	59
MVS3	27, 29
MVS5	23
TB7-20	124
TB8-17	124
TB9-13	124
TB11-14,5	124
U/M8 AG	20
U/M10 AG	14
V1311C2-A	124
ZYL-SHR-IN-6KT M10x20 ISO4762 BN610	14





● Stäubli Units    ○ Representatives/Agents

# Global presence of the Stäubli Group

[www.staubli.com](http://www.staubli.com)