



## Mike 3A

IP67 Active GPS L1 Magnetic / Adhesive Mount Patch Antenna



### Key Features

- Compact IP67-rated housing for outdoor use
- Dual mounting options: magnetic base or adhesive pad
- Ground plane independent performance
- Top hemisphere RHCP gain: 23.2 dBiC avg, 24.4 dBiC peak
- Axial ratio at zenith: 1.76 dB for improved circular polarisation
- Meets all EU compliance criteria for electronic goods

### General Description

The MIKE 3A is a compact active GPS antenna designed for L1 (1575.42 MHz) operation. Its IP67-rated housing provides durability in outdoor environments, and the antenna can be mounted using either a magnetic base or an adhesive pad. This flexibility makes it suitable for a wide range of applications where secure and reliable installation is required.

The antenna delivers strong RHCP gain across the top hemisphere, ensuring fast and stable satellite acquisition. At zenith, the low axial ratio supports excellent circular polarisation, improving signal quality and reducing multipath effects. The integrated low noise amplifier enhances weak signals and maintains low power consumption, which ensures consistent GNSS performance even in demanding conditions.

The MIKE 3A is supplied with standard cable lengths and SMA male connectors, and alternative options can be specified for high-volume projects.

### Typical Applications

- Vehicle and fleet tracking
- Asset and equipment monitoring
- Outdoor mobile applications
- General GPS positioning systems





## Electrical Specifications

Impedance:	50 $\Omega$
Polarisation:	RHCP
Frequency Range:	1575.42 MHz (GPS L1, Galileo E1, BeiDou B1C, QZSS L1)
Return Loss:	-21.6 dB
VSWR:	1.18 : 1
Ground Plane Independent:	No
RHCP Gain:	23 $\pm$ 1.5 dBiC (top hemisphere)
RHCP Gain at Zenith:	23.4 dBiC
Axial Ratio at Zenith:	1.76 dB
Noise Figure:	1.5 dB
Supply Voltage:	3.0 – 5.0 V DC
Current Consumption:	$\leq$ 10 mA

## Environmental Specifications

Operational Temperature Range:	-40 $^{\circ}$ C to +85 $^{\circ}$ C
Storage Temperature Range:	-40 $^{\circ}$ C to +100 $^{\circ}$ C
Relative Humidity:	95-100%
Ingress Protection:	IP67

## Mechanical Specifications

Dimension:	50 $\times$ 39 $\times$ 17 mm
Weight:	65 g
Connector:	SMA Male
Cable:	RG174
Mounting Methods:	Magnetic / Adhesive



## Mike 3A

IP67 Active GPS L1 Magnetic / Adhesive Mount Patch Antenna

### Dimensional Drawing

Unit: mm

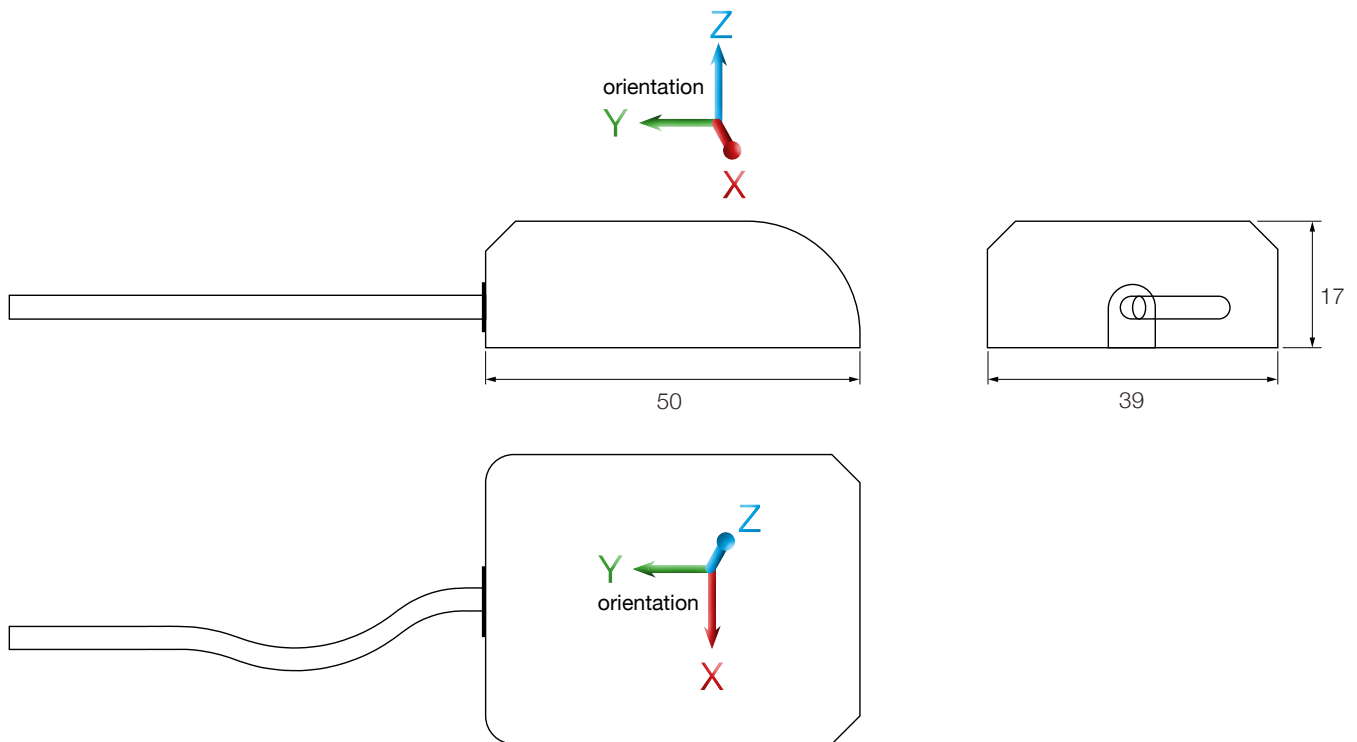



### Spectrum Coverage

GPS		
Band	Frequency	Use Indicator
L5	1176.45	●
L2	1227.6	●
L1	1575.42	●

NavIC		
Band	Frequency	Use Indicator
L5	1176.45	●

GLONASS		
Band	Frequency	Use Indicator
L3OC	1202.025	●
L2OF, L2OC	1246	●
L1OF, L1OC	1602	●

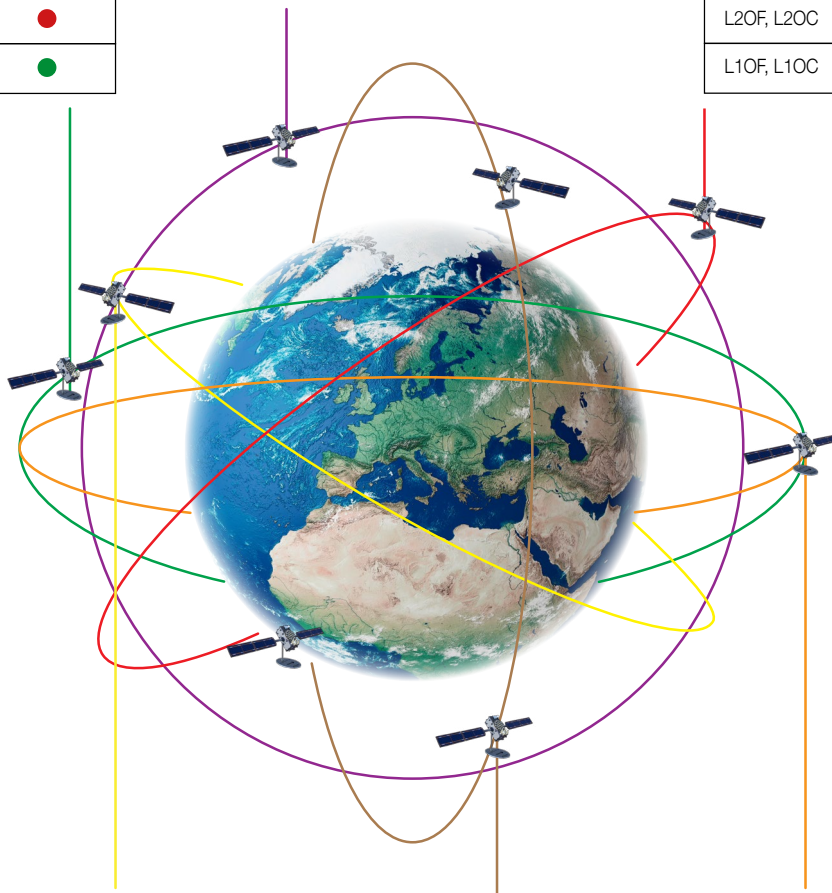

Galileo		
Band	Frequency	Use Indicator
E5a	1176.45	●
E5b	1207.14	●
E6-I, E6-Q	1278.75	●
E1-I, E1-Q	1575.42	●

BeiDou		
Band	Frequency	Use Indicator
B2a	1176.45	●
B2I, B2b	1207.14	●
B3I	1268.52	●
B1I	1561.098	●
B1C	1575.42	●

QZSS		
Band	Frequency	Use Indicator
L5	1176.45	●
L2	1227.6	●
L6	1278.75	●
L1	1575.42	●

● Suitable band

● Adequate band in good signal conditions

● Likely to be unsuitable



### GNSS Standards Band Support

Centre Frequency (MHz)	Electrical Interface		Spherical RF Measurements			
	VSWR	Return Loss (dB)	Average RHCP Gain (dBiC)	Peak RHCP Gain (dBiC)	Median Axial Ratio (dB)	Minimum Axial Ratio (dB)
1575.42	1.1823	-21.6160	19.96	24.40	4.41	0.16

Centre Frequency (MHz)	Top hemisphere RF Measurements				Zenith RF Measurements	
	Average RHCP Gain (dBiC)	Peak RHCP Gain (dBiC)	Median Axial Ratio (dB)	Minimum Axial Ratio (dB)	RHCP Gain at Zenith (dBiC)	Axial Ratio at Zenith (dB)
1575.42	23.19	24.40	3.16	0.16	23.40	1.76



## Mike 3A

IP67 Active GPS L1 Magnetic / Adhesive Mount Patch Antenna

### Electrical

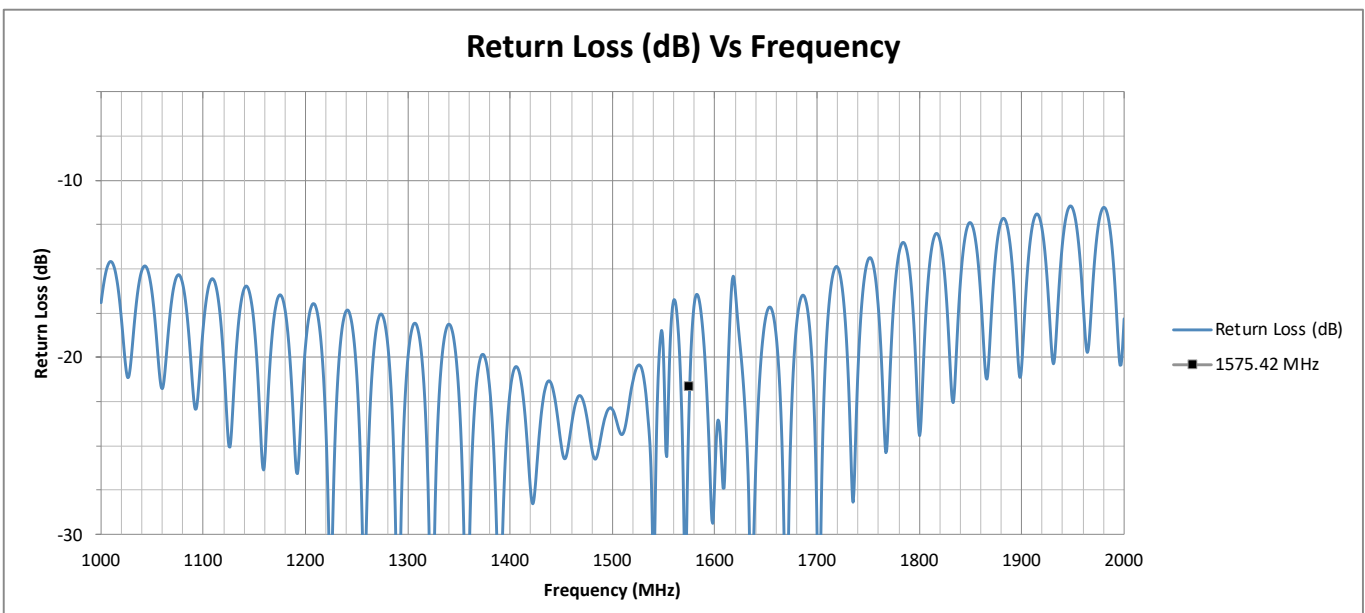
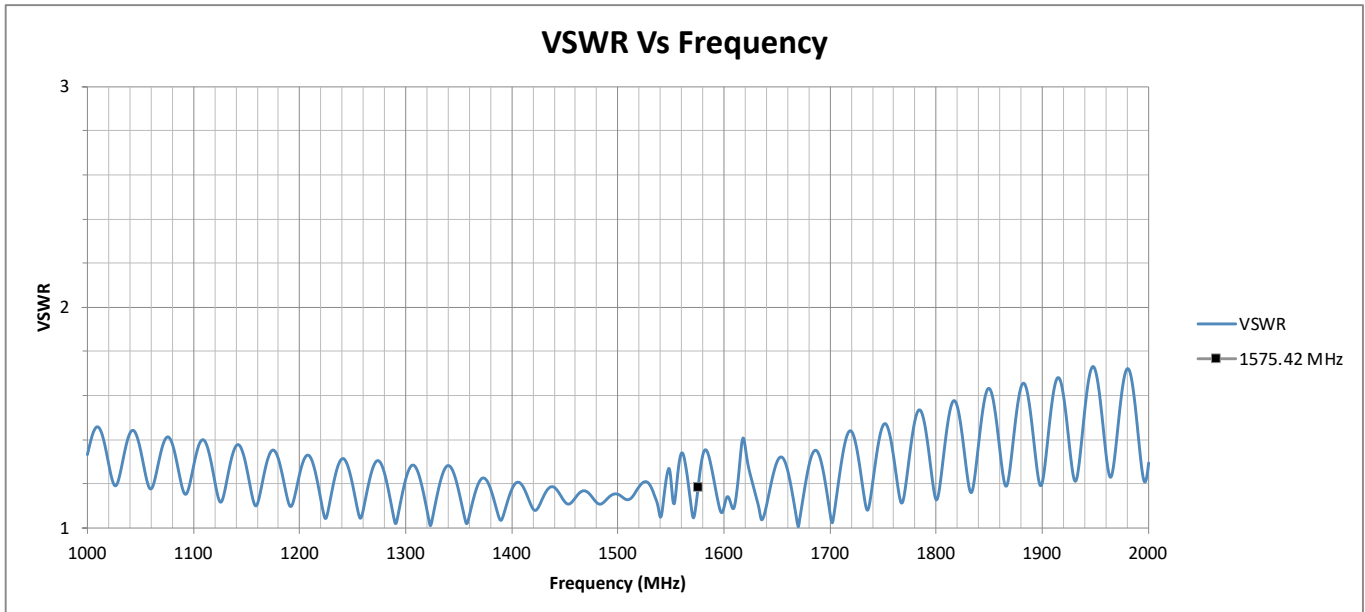



## Mike 3A

IP67 Active GPS L1 Magnetic / Adhesive Mount Patch Antenna

### RF Zenith

This page presents the RHCP Gain at Zenith and the Axial Ratio at Zenith as a function of frequency. These measurements indicate how well the antenna performs when receiving signals directly from satellites overhead (zenith direction). A higher RHCP gain ensures strong signal reception, while a lower axial ratio signifies better polarization purity for optimal GNSS performance.

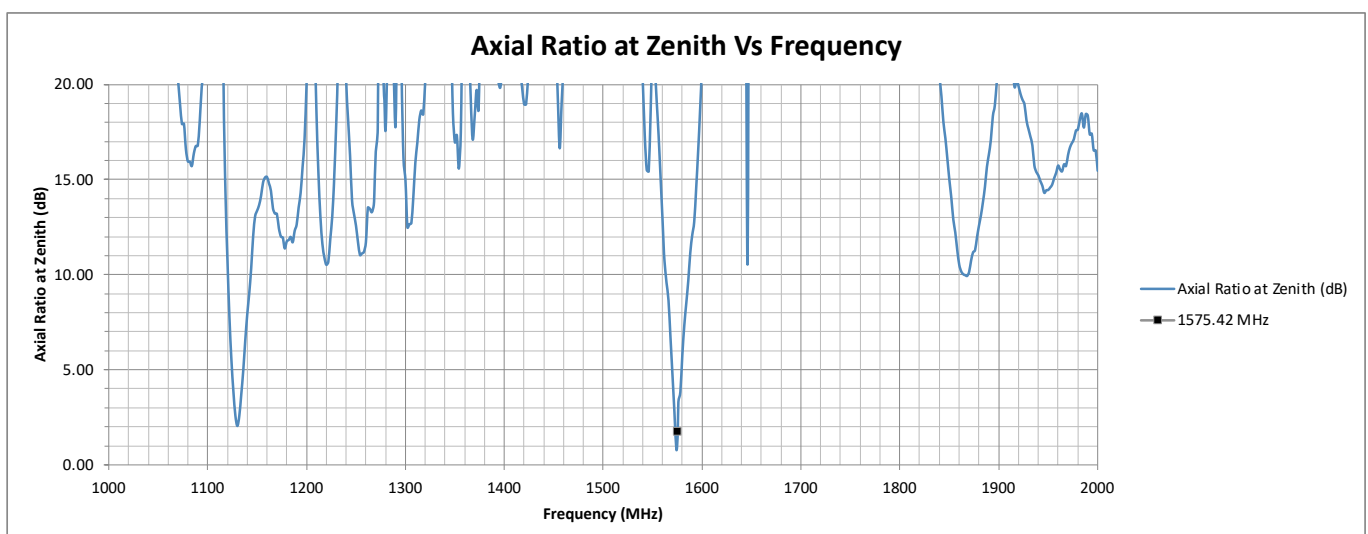
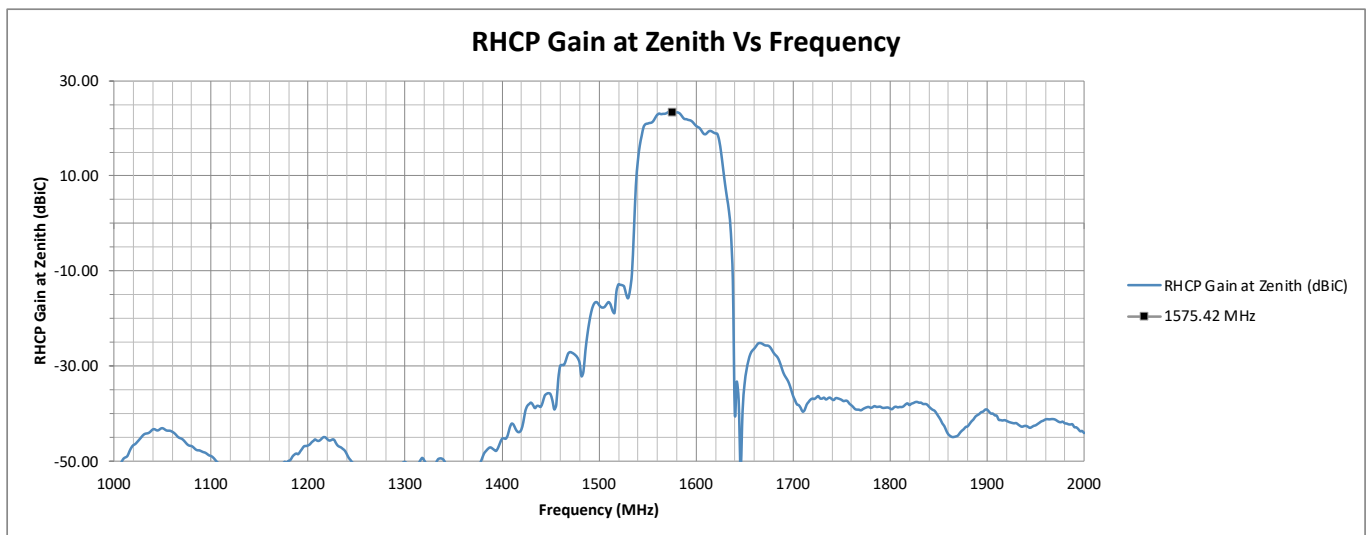
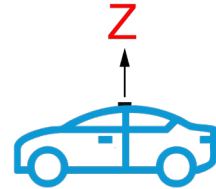



## Mike 3A

IP67 Active GPS L1 Magnetic / Adhesive Mount Patch Antenna

### RF Top Hemisphere

The graphs on this page showcase the Average and Peak RHCP Gain in the Top Hemisphere. These measurements assess how effectively the antenna receives signals from satellites positioned in the upper half of the sky. Strong RHCP gain in this region is critical for reliable GNSS reception, especially in environments where satellites may not always be directly overhead.

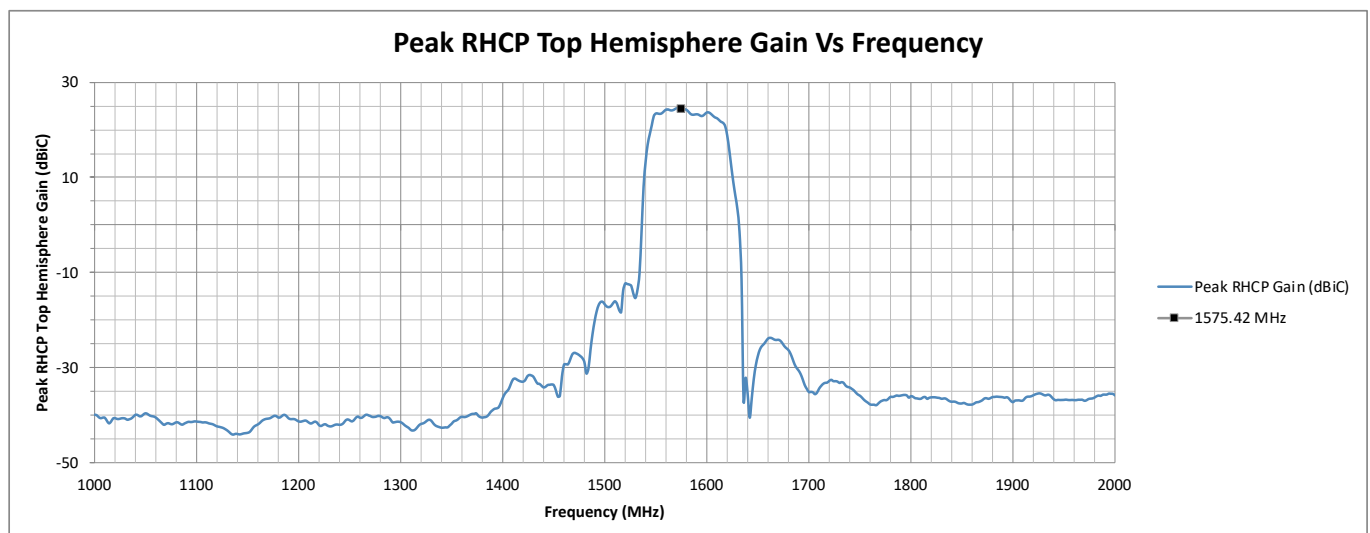
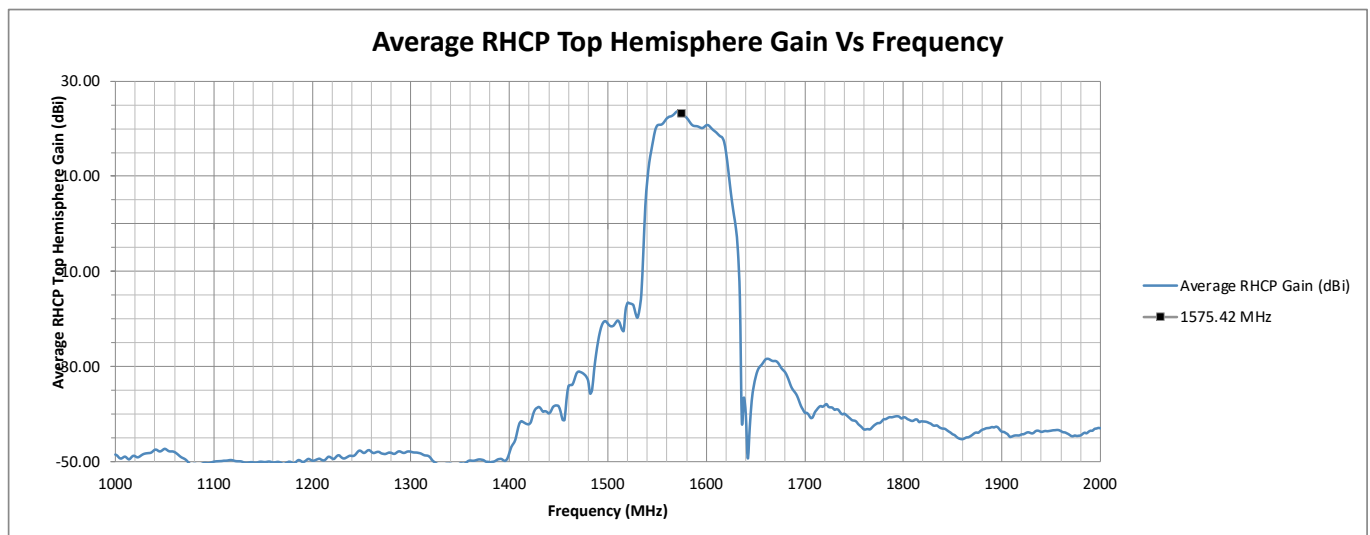
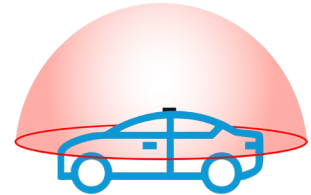



## Mike 3A

IP67 Active GPS L1 Magnetic / Adhesive Mount Patch Antenna

### RF Spherical

This page displays the Average and Peak RHCP Gain across the entire spherical coverage of the antenna. These metrics provide a comprehensive view of the antenna's ability to receive signals from satellites at all elevations and directions. Consistently high gain across the sphere ensures strong and stable GNSS reception in a variety of operating conditions.

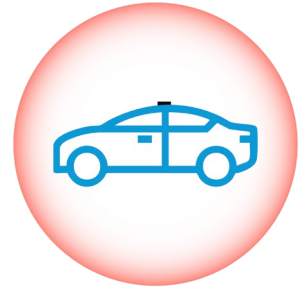

Peak RHCP Top Hemisphere Gain Vs Frequency

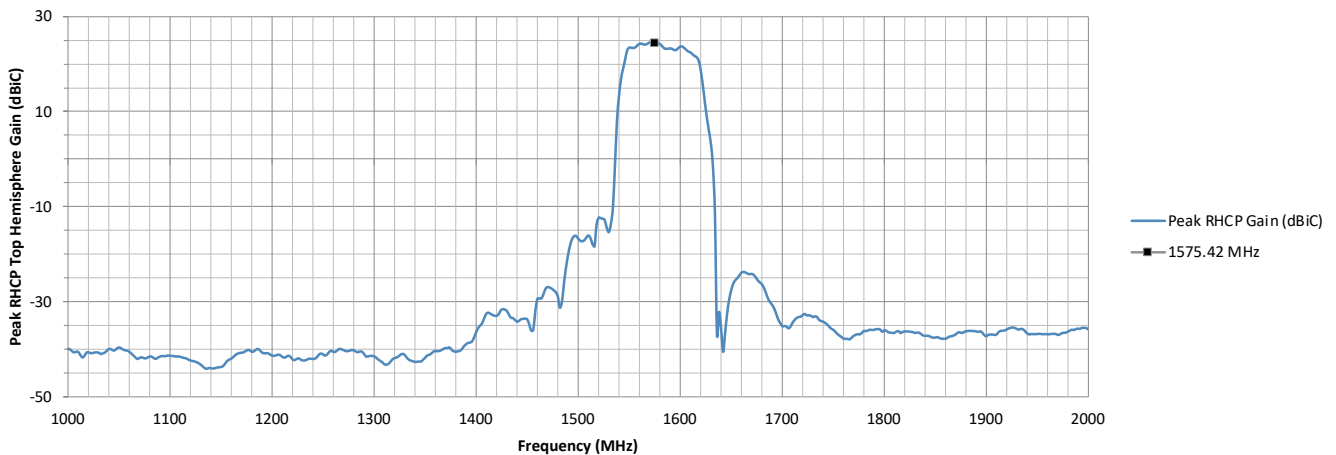

Peak RHCP Spherical Gain Vs Frequency

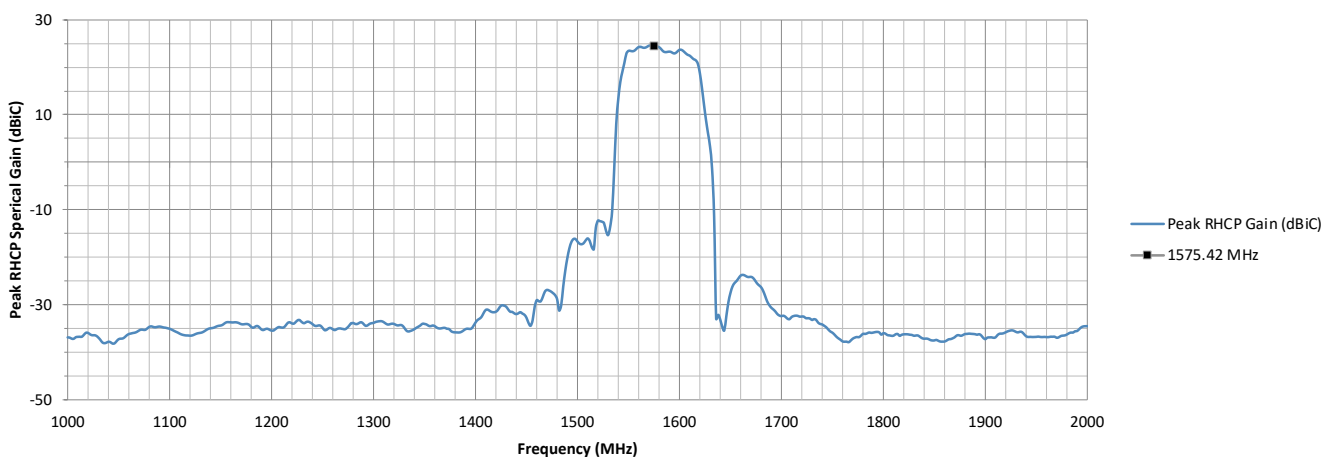



### ZX and YZ Plane Axial Ratio Plots (Zenith is at 0 degrees)

This page shows how well the antenna maintains circular polarization at different elevation angles.

A lower axial ratio ensures better GNSS signal reception, especially at low elevations, which is crucial for applications requiring strong performance in obstructed environments or wide-angle satellite visibility.

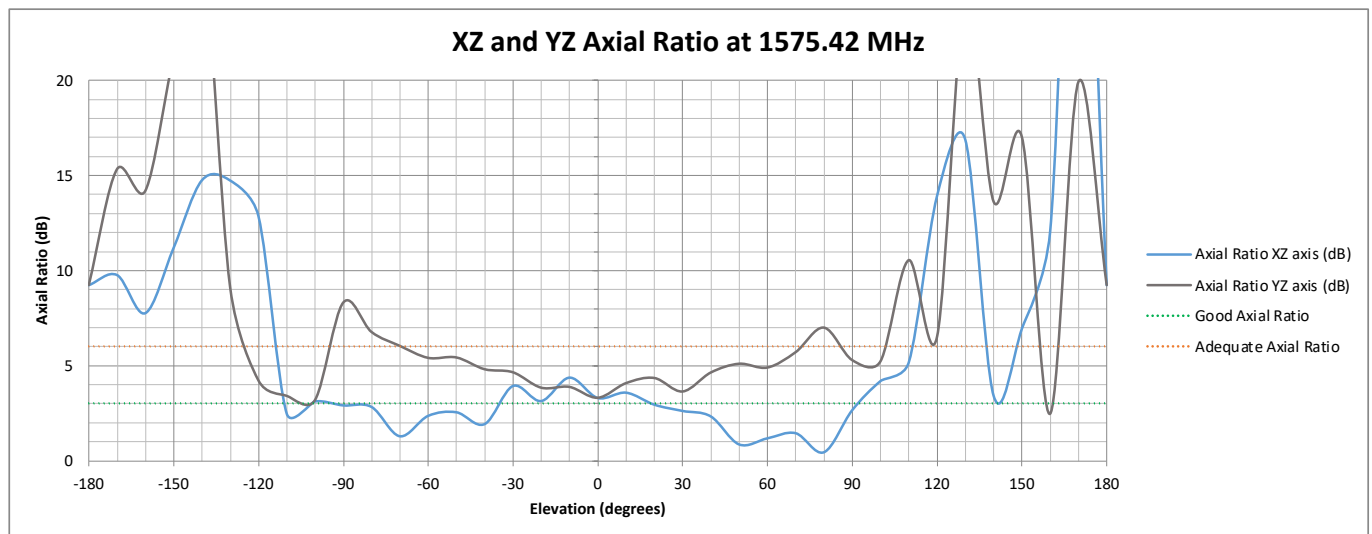
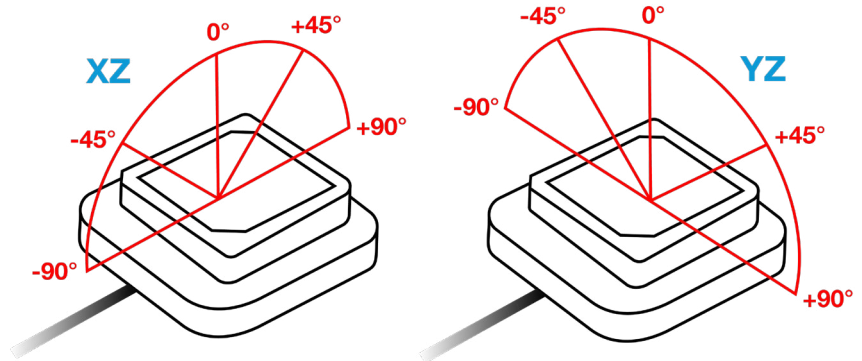



## Mike 3A

IP67 Active GPS L1 Magnetic / Adhesive Mount Patch Antenna

### Test Setup (in 100 mm Ground Plane)

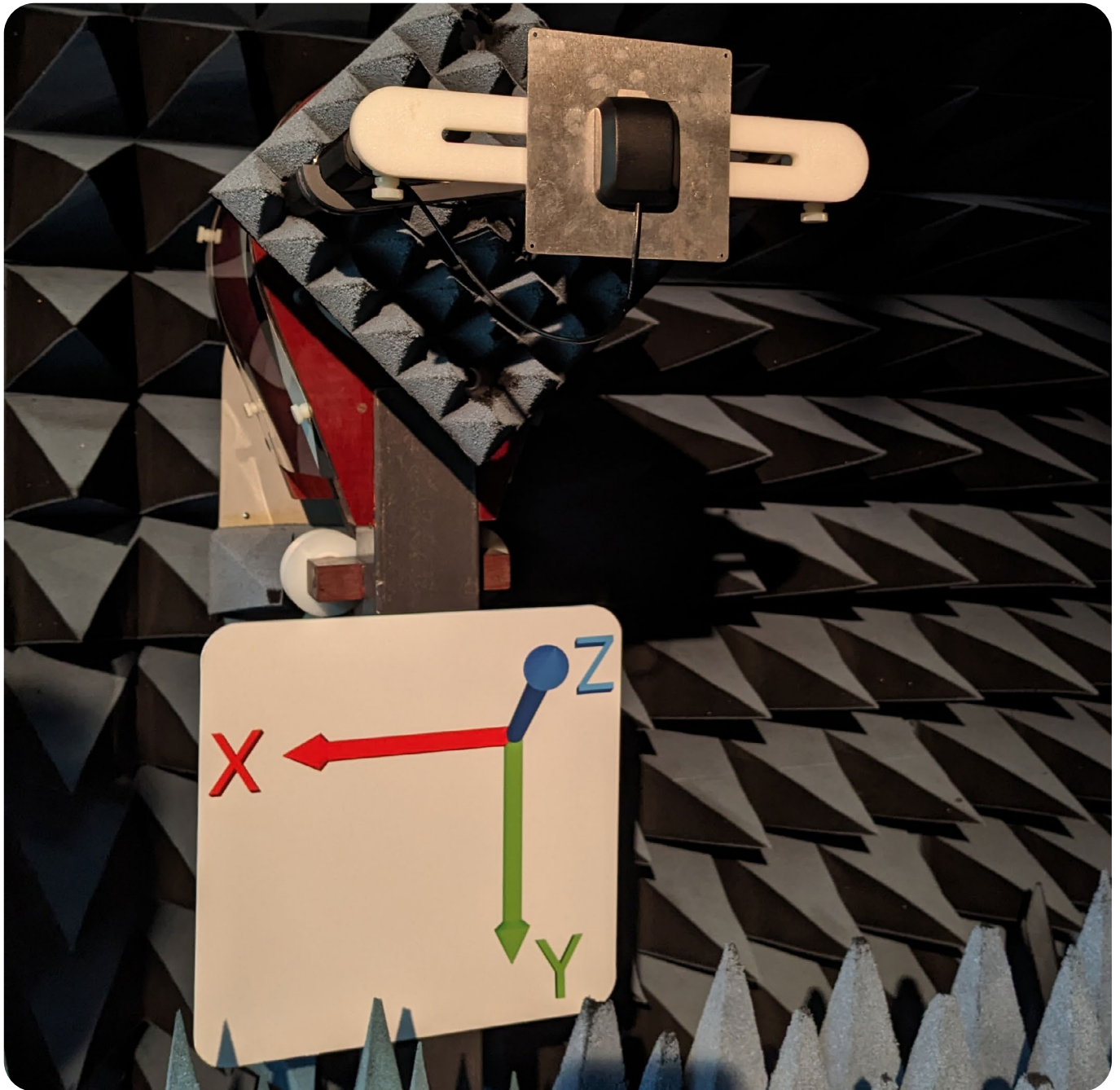



## Mike 3A

IP67 Active GPS L1 Magnetic / Adhesive Mount Patch Antenna

### 2D Radiation Plots (1575.42 MHz)

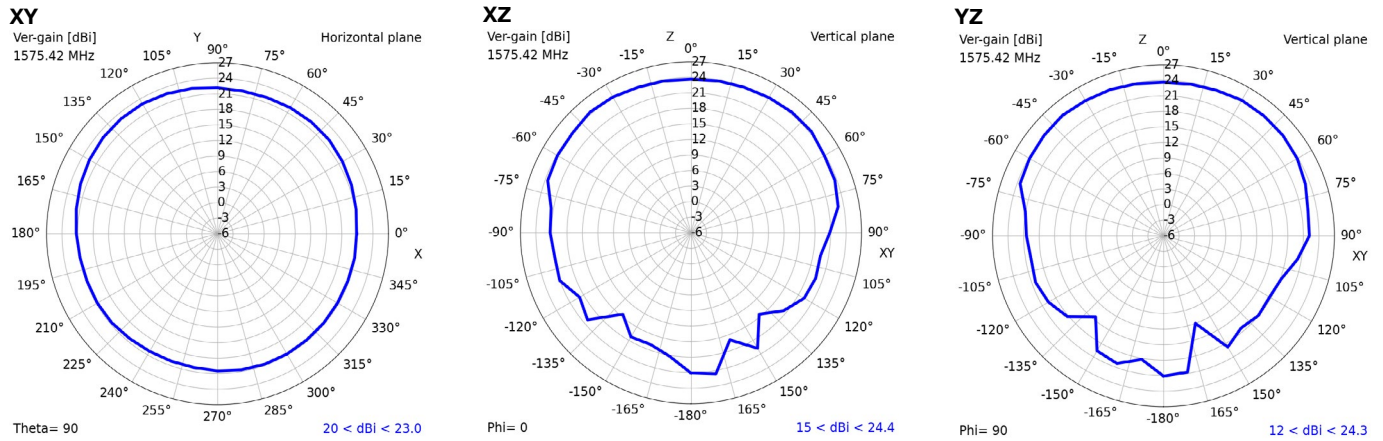

### 3D Radiation Plot (1575.42 MHz)

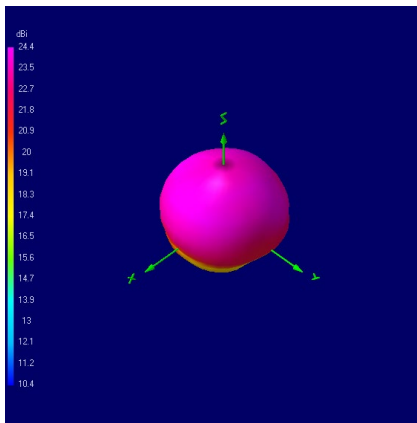

**NOTE:** All 3D radiation plots are shown with Theta = 45 and Phi = 45.

**Mike 3A**

IP67 Active GPS L1 Magnetic / Adhesive Mount Patch Antenna

**Ordering Details:**

Part Number	Description
MIKE3A/0.5M/SMAM/RA/S/17	GPS L1 IP67 Antenna, SMA Male Right Angle Connector, 0.5 m Cable
MIKE3A/2.5M/SMAM/S/S/17	GPS L1 IP67 Antenna, SMA Male Connector, 2.5 m Cable
MIKE3A/3M/SMAM/S/S/17	GPS L1 IP67 Antenna, SMA Male Connector, 3 m Cable
MIKE3A/5M/SMAM/S/S/17	GPS L1 IP67 Antenna, SMA Male Connector, 5 m Cable
MIKE3A/5M/SMAM/S/RA/17	GPS L1 IP67 Antenna, SMA Male Right Angle Connector, 5 m Cable

*Alternative cable lengths and connector types can be specified for high-volume projects.  
Please email - [siretta@sales.com](mailto:siretta@sales.com)*