

公差/General tolerances(mm)											0.1/10		
0	>3	>6	>10	>18	>30	>50	>80	>120	>180	>250		>315	>400
±0.12	±0.18	±0.22	±0.26	±0.31	±0.37	±0.57	±0.80	±0.93	±1.05	±1.15	±1.60	±2.20	±2.50

A

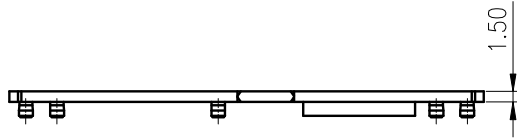

B

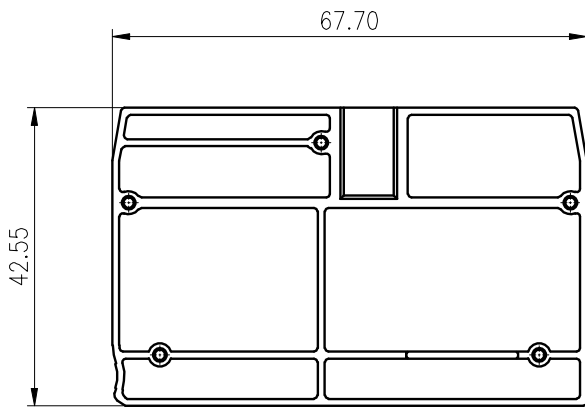

C

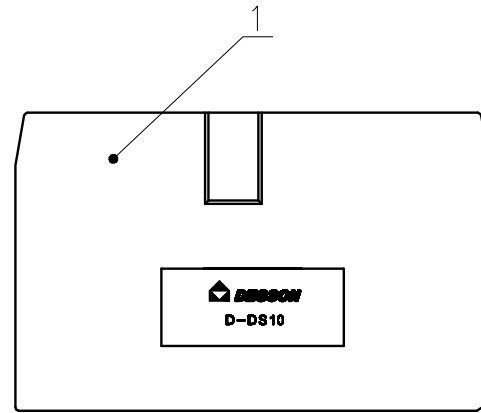
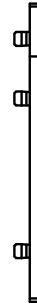

D

1	Cover	PA66	UL94V-0
ITEM	NAME OF PART	MATERIAL	NOTES
使用温度范围/Operating temperature(°C)			-40~+105
符合RoHS环保要求/Conform to RoHS			Yes
标准颜色编号/Standard color number:			/
PANTONE / RAL			/

MATERIAL: /	SURFACE: /		
MAT NO.: /	宁波高松电子有限公司 NINGBO DEGSON ELECTRICAL CO., LTD		
STATUS: /			
APPD: Li GL 2020.06.01	NAME: D-DS10-01P-1Y-00A(H)		
CHKD: Mao J 2020.06.01	DRAWING NO.: D-DS10-C01		
DRFT: Wang LX 2020.06.01	REV	T0-3	
SIZE: A4 TYPE: CUSTOMER DRAWING SCALE: 1:1 SHEET 1/1			

REV	ECN	DESCRIPTION	DRFT	DATE

1

2

3

4

5

6