

N-CHANNEL ENHANCEMENT MODE VERTICAL DMOS FET

ZVN2106A

ISSUE 2 – MARCH 94

FEATURES

- * 60 Volt V_{DS}
- * $R_{DS(on)}=2\Omega$

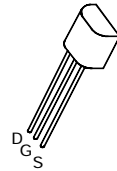

E-Line
TO92 Compatible

ABSOLUTE MAXIMUM RATINGS.

PARAMETER	SYMBOL	VALUE	UNIT
Drain-Source Voltage	V_{DS}	60	V
Continuous Drain Current at $T_{amb}=25^{\circ}C$	I_D	450	mA
Pulsed Drain Current	I_{DM}	8	A
Gate Source Voltage	V_{GS}	± 20	V
Power Dissipation at $T_{amb}=25^{\circ}C$	P_{tot}	700	mW
Operating and Storage Temperature Range	$T_j:T_{stg}$	-55 to +150	$^{\circ}C$

ELECTRICAL CHARACTERISTICS (at $T_{amb} = 25^{\circ}C$ unless otherwise stated).

PARAMETER	SYMBOL	MIN.	MAX.	UNIT	CONDITIONS.
Drain-Source Breakdown Voltage	BV_{DSS}	60		V	$I_D=1mA, V_{GS}=0V$
Gate-Source Threshold Voltage	$V_{GS(th)}$	0.8	2.4	V	$I_D=1mA, V_{DS}=V_{GS}$
Gate-Body Leakage	I_{GSS}		20	nA	$V_{GS}=\pm 20V, V_{DS}=0V$
Zero Gate Voltage Drain Current	I_{DSS}		500 100	nA μA	$V_{DS}=60V, V_{GS}=0$ $V_{DS}=48V, V_{GS}=0V,$ $T=125^{\circ}C(2)$
On-State Drain Current(1)	$I_{D(on)}$	2		A	$V_{DS}=18V, V_{GS}=10V$
Static Drain-Source On-State Resistance (1)	$R_{DS(on)}$		2	Ω	$V_{GS}=10V, I_D=1A$
Forward Transconductance (1)(2)	g_{fs}	300		mS	$V_{DS}=18V, I_D=1A$
Input Capacitance (2)	C_{iss}		75	pF	$V_{DS}=18V, V_{GS}=0V, f=1MHz$
Common Source Output Capacitance (2)	C_{oss}		45	pF	
Reverse Transfer Capacitance (2)	C_{rss}		20	pF	

ZVN2106A

TYPICAL CHARACTERISTICS

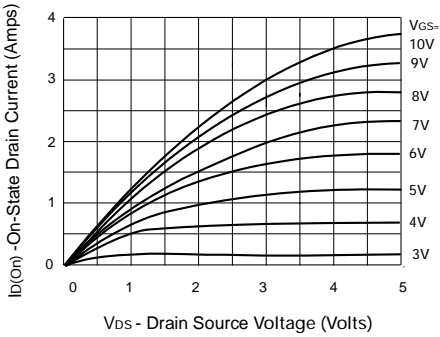

Saturation Characteristics

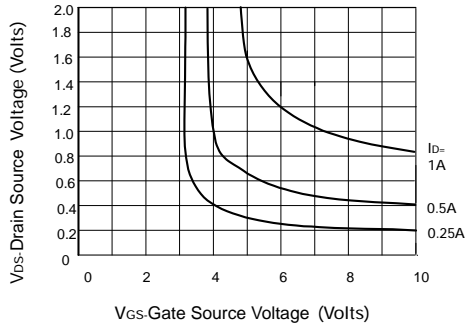

Voltage Saturation Characteristics

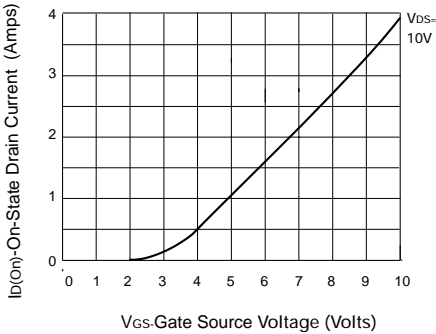

Transfer Characteristics

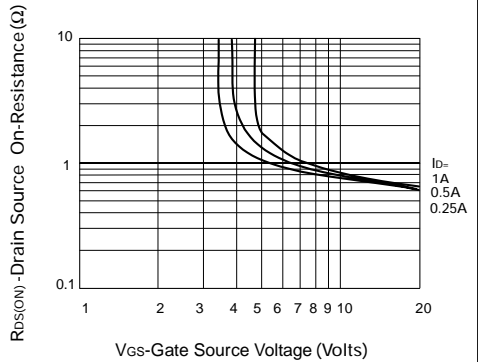

On-resistance v gate-source voltage

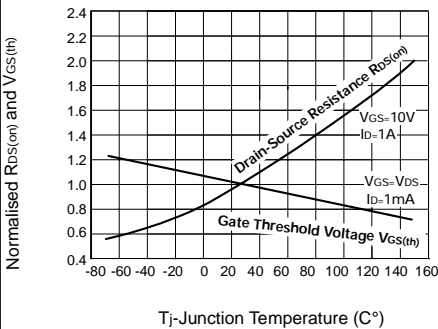

Normalised $R_{DS(on)}$ and $V_{GS(th)}$ vs Temperature

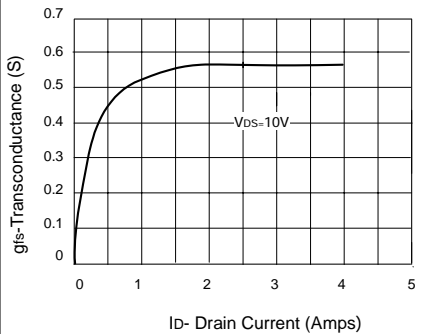

Transconductance v drain current

TYPICAL CHARACTERISTICS

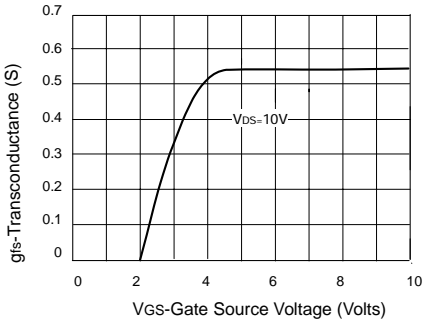

Transconductance v gate-source voltage

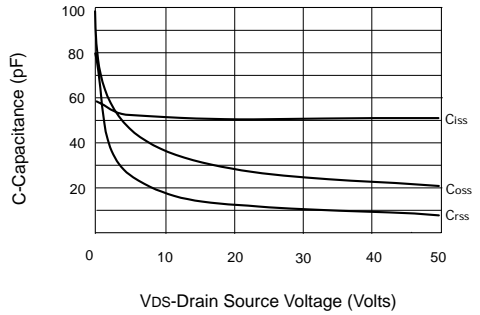

Capacitance v drain-source voltage

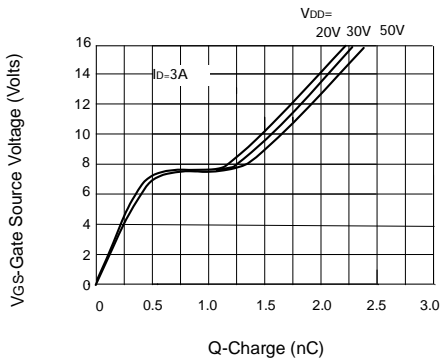

Gate charge v gate-source voltage