

# HSMS-280x

## Surface Mount RF Schottky Barrier Diodes



### Data Sheet



#### Description/Applications

These Schottky diodes are specifically designed for both analog and digital applications. This series offers a wide range of specifications and package configurations to give the designer wide flexibility. The HSMS-280x series of diodes is optimized for high voltage applications.

Note that Avago's manufacturing techniques assure that dice found in pairs and quads are taken from adjacent sites on the wafer, assuring the highest degree of match.

#### Features

- Surface Mount Packages
- High Breakdown Voltage
- Low FIT (Failure in Time) Rate\*
- Six-sigma Quality Level
- Single, Dual and Quad Versions
- Tape and Reel Options Available
- Lead-free

\* For more information see the Surface Mount Schottky Reliability Data Sheet.

#### Package Lead Code Identification, SOT-323 (Top View)

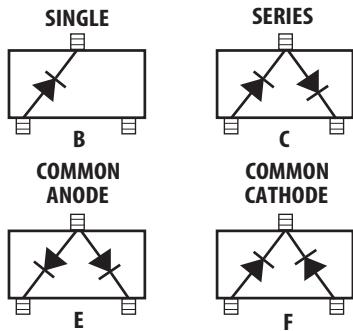

#### Package Lead Code Identification, SOT-363 (Top View)

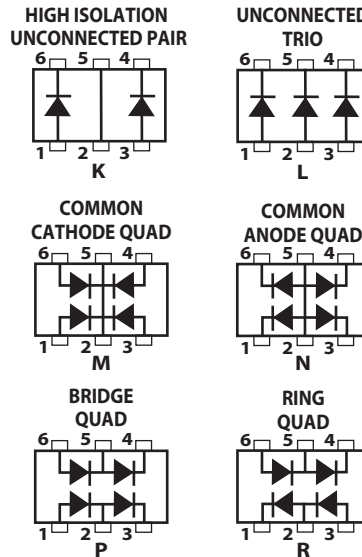

#### Package Lead Code Identification, SOT-23/SOT-143 (Top View)

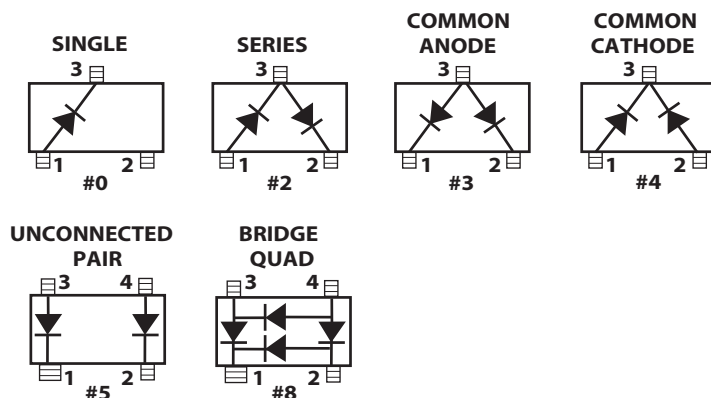

## Pin Connections and Package Marking, SOT-363

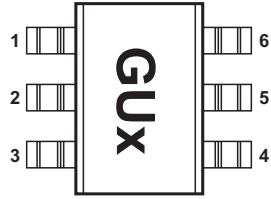

### Notes:

1. Package marking provides orientation and identification.
2. See "Electrical Specifications" for appropriate package marking.

### ESD WARNING:

Handling Precautions Should Be Taken To Avoid Static Discharge.

## Absolute Maximum Ratings<sup>[1]</sup> $T_C = 25^\circ\text{C}$

Symbol	Parameter	Unit	SOT-23/SOT-143	SOT-323/SOT-363
$I_f$	Forward Current (1 $\mu\text{s}$ Pulse)	Amp	1	1
$P_{IV}$	Peak Inverse Voltage	V	Same as $V_{BR}$	Same as $V_{BR}$
$T_j$	Junction Temperature	$^\circ\text{C}$	150	150
$T_{stg}$	Storage Temperature	$^\circ\text{C}$	-65 to 150	-65 to 150
$\theta_{jc}$	Thermal Resistance <sup>[2]</sup>	$^\circ\text{C}/\text{W}$	500	150

### Notes:

1. Operation in excess of any one of these conditions may result in permanent damage to the device.
2.  $T_C = +25^\circ\text{C}$ , where  $T_C$  is defined to be the temperature at the package pins where contact is made to the circuit board.

## Electrical Specifications $T_A = 25^\circ\text{C}$ , Single Diode<sup>[3]</sup>

Part Number HSMS <sup>[4]</sup>	Package Marking Code	Lead Code	Configuration	Minimum Breakdown Voltage $V_{BR}$ (V)	Maximum Forward Voltage $V_F$ (mV)	Maximum Forward Voltage $V_F$ (V) @ $I_F$ (mA)	Maximum Reverse Leakage $I_R$ (nA) @ $V_R$ (V)	Maximum Capacitance $C_T$ (pF)	Typical Dynamic Resistance $R_D$ ( $\Omega$ ) <sup>[5]</sup>
2800	A0	0	Single						
2802	A2	2	Series						
2803	A3	3	Common Anode						
2804	A4	4	Common Cathode						
2805	A5	5	Unconnected Pair						
2808	A8	8	Bridge Quad <sup>[4]</sup>						
280B	A0	B	Single						
280C	A2	C	Series						
280E	A3	E	Common Anode	70	410	1.0 @ 15	200 @ 50	2.0	35
280F	A4	F	Common Cathode						
280K	AK	K	High Isolation Unconnected Pair						
280L	AL	L	Unconnected Trio						
280M	H	M	Common Cathode Quad						
280N	N	N	Common Anode Quad						
280P	AP	P	Bridge Quad						
280R	O	R	Ring Quad						
Test Conditions				$I_R = 10 \text{ mA}$	$I_F = 1 \text{ mA}$			$V_F = 0 \text{ V}$ $f = 1 \text{ MHz}$	$I_F = 5 \text{ mA}$

### Notes:

1.  $DV_F$  for diodes in pairs and quads in 15 mV maximum at 1 mA.
2.  $DC_{TO}$  for diodes in pairs and quads is 0.2 pF maximum.
3. Effective Carrier Lifetime ( $t$ ) for all these diodes is 100 ps maximum measured with Krakauer method at 5 mA.
4. See section titled "Quad Capacitance."
5.  $R_D = R_S + 5.2 \Omega$  at  $25^\circ\text{C}$  and  $I_F = 5 \text{ mA}$ .

## Quad Capacitance

Capacitance of Schottky diode quads is measured using an HP4271 LCR meter. This instrument effectively isolates individual diode branches from the others, allowing accurate capacitance measurement of each branch or each diode. The conditions are: 20 mV R.M.S. voltage at 1 MHz. Avago defines this measurement as "CM", and it is equivalent to the capacitance of the diode by itself. The equivalent diagonal and adjacent capacitances can then be calculated by the formulas given below.

In a quad, the diagonal capacitance is the capacitance between points A and B as shown in the figure below. The diagonal capacitance is calculated using the following formula

$$C_{\text{DIAGONAL}} = \frac{C_1 \times C_2}{C_1 + C_2} + \frac{C_3 \times C_4}{C_3 + C_4}$$

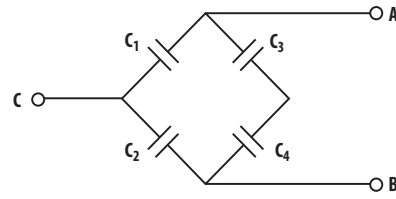

The equivalent adjacent capacitance is the capacitance between points A and C in the figure below. This capacitance is calculated using the following formula

$$C_{\text{ADJACENT}} = C_1 + \frac{1}{\frac{1}{C_2} + \frac{1}{C_3} + \frac{1}{C_4}}$$

This information does not apply to cross-over quad diodes.

## Linear Equivalent Circuit, Diode Chip

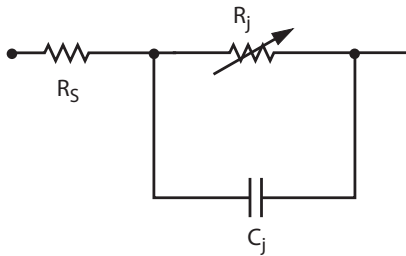

$R_S$  = series resistance (see Table of SPICE parameters)

$C_j$  = junction capacitance (see Table of SPICE parameters)

$$R_j = \frac{8.33 \times 10^{-5} \text{ nT}}{I_b + I_s}$$

where

$I_b$  = externally applied bias current in amps

$I_s$  = saturation current (see table of SPICE parameters)

T = temperature, K

n = ideality factor (see table of SPICE parameters)

Note:

To effectively model the packaged HSMS-280x product, please refer to Application Note AN1124.

## SPICE Parameters

Parameter	Units	HSMS-280x
$B_V$	V	75
$C_{J0}$	pF	1.6
$E_G$	eV	0.69
$I_{BV}$	A	E-5
$I_S$	A	3.00E-08
N		1.08
$R_S$	$\Omega$	30
$P_B$	V	0.65
$P_T$		2
M		0.5

**Typical Performance,  $T_C = 25^\circ\text{C}$  (unless otherwise noted), Single Diode**

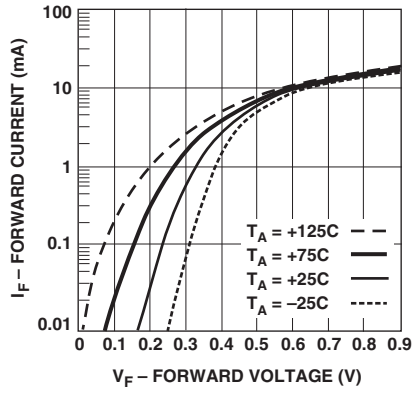

**Figure 1. Forward Current vs. Forward Voltage at Temperatures.**

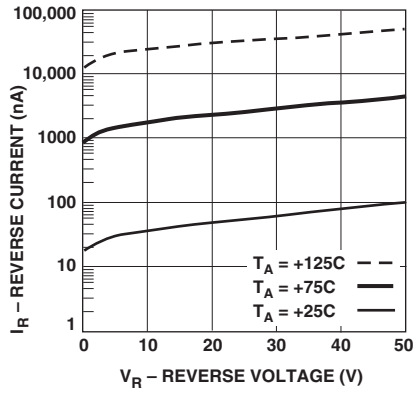

**Figure 2. Reverse Current vs. Reverse Voltage at Temperatures.**

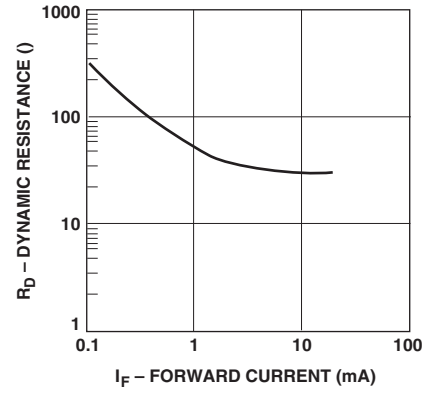

**Figure 3. Dynamic Resistance vs. Forward Current.**

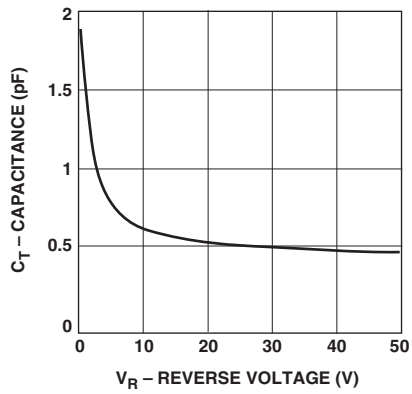

**Figure 4. Total Capacitance vs. Reverse Voltage.**

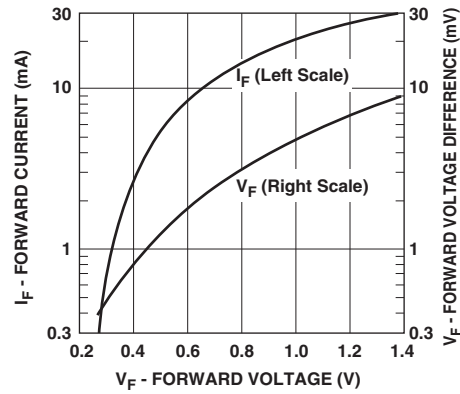

**Figure 5. Typical  $V_f$  Match, Pairs and Quads.**

## Applications Information Introduction — Product Selection

Avago's family of Schottky products provides unique solutions to many design problems.

The first step in choosing the right product is to select the diode type. All of the products in the HSMS-280x family use the same diode chip, and the same is true of the HSMS-281x and HSMS-282x families. Each family has a different set of characteristics which can be compared most easily by consulting the SPICE parameters in Table 1.

A review of these data shows that the HSMS-280x family has the highest breakdown voltage, but at the expense of a high value of series resistance ( $R_s$ ). In applications which do not require high voltage the HSMS-282x family, with a lower value of series resistance, will offer higher current carrying capacity and better performance. The HSMS-281x family is a hybrid Schottky (as is the HSMS-280x), offering lower 1/f or flicker noise than the HSMS-282x family.

In general, the HSMS-282x family should be the designer's first choice, with the -280x family reserved for high voltage applications and the HSMS-281x family for low flicker noise applications.

## Assembly Instructions

### SOT-323 PCB Footprint

A recommended PCB pad layout for the miniature SOT-323 (SC-70) package is shown in Figure 6 (dimensions are in inches). This layout provides ample allowance for package placement by automated assembly equipment without adding parasitics that could impair the performance.

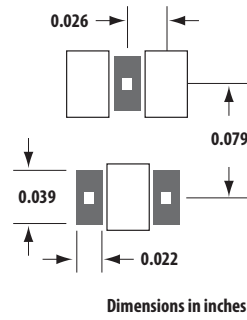

Figure 6. Recommended PCB Pad Layout for Avago's SC70 3L/SOT-323 Products.

## Assembly Instructions

### SOT-363 PCB Footprint

A recommended PCB pad layout for the miniature SOT-363 (SC-70, 6 lead) package is shown in Figure 7 (dimensions are in inches). This layout provides ample allowance for package placement by automated assembly equipment without adding parasitics that could impair the performance.

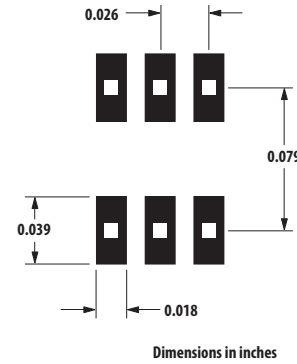

Figure 7. Recommended PCB Pad Layout for Avago's SC70 6L/SOT-363 Products.

Table 1. Typical SPICE Parameters

Parameter	Units	HSMS-280x	HSMS-281x	HSMS-282x
$B_V$	V	75	25	15
$C_{J0}$	pF	1.6	1.1	0.7
$E_G$	eV	0.69	0.69	0.69
$I_{BV}$	A	1 E-5	1 E-5	1 E-4
$I_S$	A	3 E-8	4.8 E-9	2.2 E-8
$N$		1.08	1.08	1.08
$R_S$	$\Omega$	30	10	6
$P_B (V_J)$	V	0.65	0.65	0.65
$P_T (XTI)$		2	2	2
$M$		0.5	0.5	0.5

## SMT Assembly

Reliable assembly of surface mount components is a complex process that involves many material, process, and equipment factors, including: method of heating (e.g., IR or vapor phase reflow, wave soldering, etc.) circuit board material, conductor thickness and pattern, type of solder alloy, and the thermal conductivity and thermal mass of components. Components with a low mass, such as the SOT package, will reach solder reflow temperatures faster than those with a greater mass.

Avago's SOT diodes have been qualified to the time-temperature profile shown in Figure 8. This profile is representative of an IR reflow type of surface mount assembly process.

After ramping up from room temperature, the circuit board with components attached to it (held in place with solder paste) passes through one or more preheat

zones. The preheat zones increase the temperature of the board and components to prevent thermal shock and begin evaporating solvents from the solder paste. The reflow zone briefly elevates the temperature sufficiently to produce a reflow of the solder.

The rates of change of temperature for the ramp-up and cool-down zones are chosen to be low enough to not cause deformation of the board or damage to components due to thermal shock. The maximum temperature in the reflow zone ( $T_{MAX}$ ) should not exceed 260°C.

These parameters are typical for a surface mount assembly process for Avago diodes. As a general guideline, the circuit board and components should be exposed only to the minimum temperatures and times necessary to achieve a uniform reflow of solder.

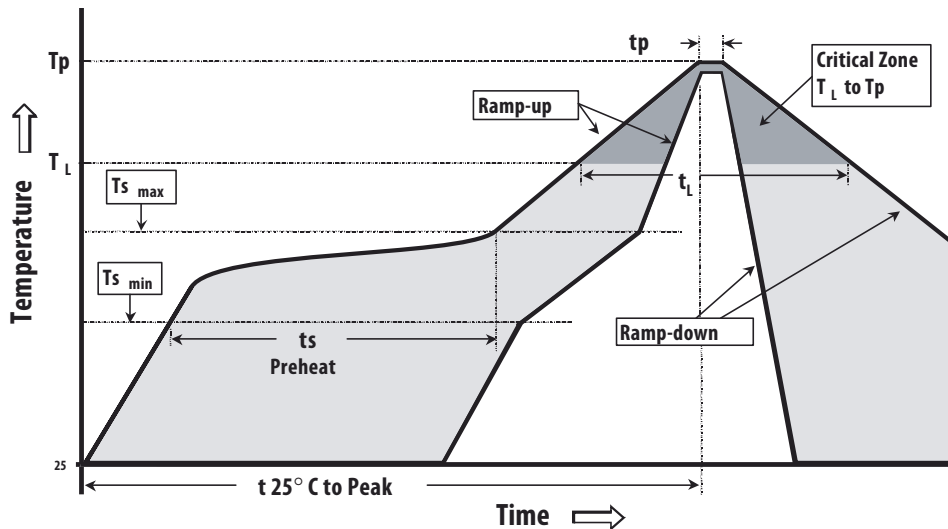

Figure 8. Surface Mount Assembly Profile.

### Lead-Free Reflow Profile Recommendation (IPC/JEDEC J-STD-020C)

Reflow Parameter	Lead-Free Assembly	
Average ramp-up rate (Liquidus Temperature ( $T_{S(max)}$ ) to Peak)	3°C/ second max	
Preheat	Temperature Min ( $T_{S(min)}$ )	150°C
	Temperature Max ( $T_{S(max)}$ )	200°C
	Time (min to max) ( $t_s$ )	60-180 seconds
$T_{S(max)}$ to $T_L$ Ramp-up Rate	3°C/second max	
Time maintained above:	Temperature ( $T_L$ )	217°C
	Time ( $t_L$ )	60-150 seconds
Peak Temperature ( $T_p$ )	260 +0/-5°C	
Time within 5 °C of actual Peak temperature ( $t_p$ )	20-40 seconds	
Ramp-down Rate	6°C/second max	
Time 25 °C to Peak Temperature	8 minutes max	

Note 1: All temperatures refer to topside of the package, measured on the package body surface

## Part Number Ordering Information

Part Number	No. of Devices	Container
HSMS-280x-TR2G	10000	13" Reel
HSMS-280x-TR1G	3000	7" Reel
HSMS-280x-BLKG	100	antistatic bag

x = 0, 2, 3, 4, 5, 8, B, C, E, F, K, L, M, N, P, R

## Package Dimensions

### Outline 23 (SOT-23)

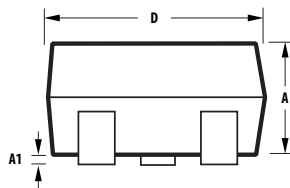
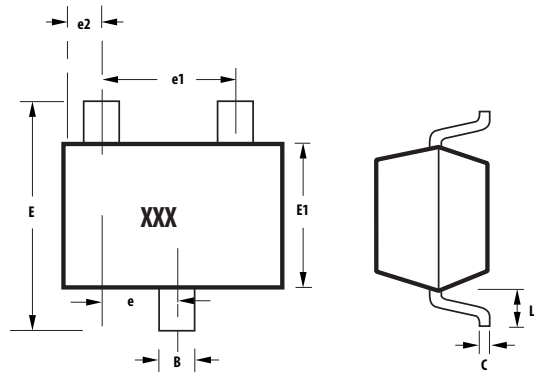

Notes:  
XXX-package marking  
Drawings are not to scale

SYMBOL	DIMENSIONS (mm)	
	MIN.	MAX.
A	0.79	1.20
A1	0.000	0.100
B	0.30	0.54
C	0.08	0.20
D	2.73	3.13
E1	1.15	1.50
e	0.89	1.02
e1	1.78	2.04
e2	0.45	0.60
E	2.10	2.70
L	0.45	0.69

### Outline SOT-323 (SC-70 3 Lead)

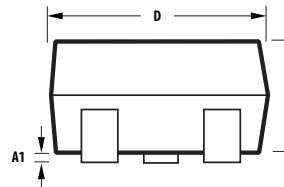
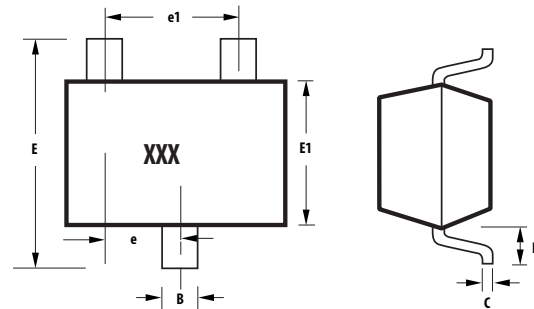

Notes:  
XXX-package marking  
Drawings are not to scale

SYMBOL	DIMENSIONS (mm)	
	MIN.	MAX.
A	0.80	1.00
A1	0.00	0.10
B	0.15	0.40
C	0.08	0.25
D	1.80	2.25
E1	1.10	1.40
e	0.65 typical	
e1	1.30 typical	
E	1.80	2.40
L	0.26	0.46

## Package Dimensions (Continued)

### Outline 143 (SOT-143)

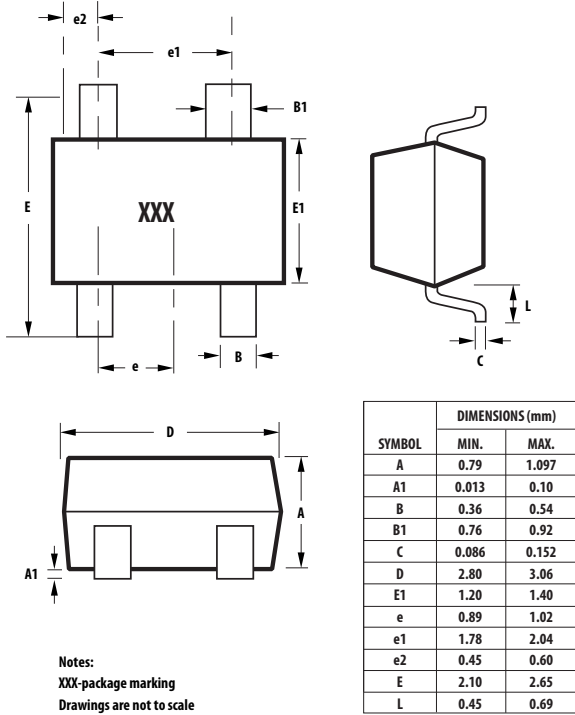

### Outline SOT-363 (SC-70 6 Lead)

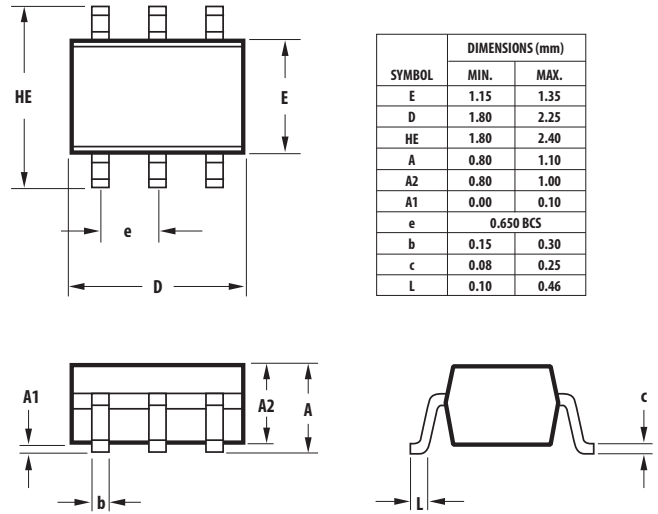

### Device Orientation

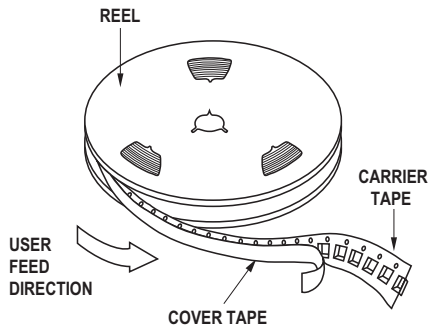

### For Outlines SOT-23, -323

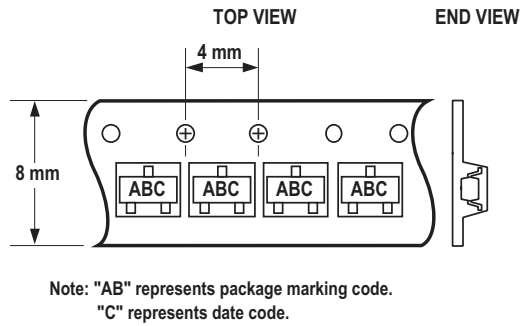

### For Outline SOT-143

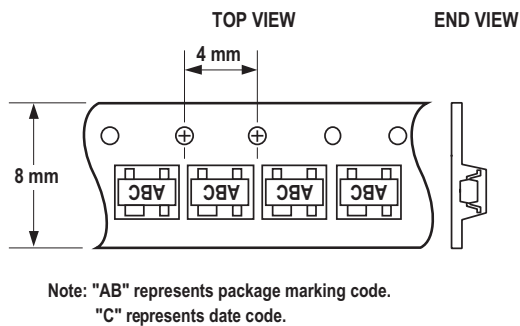

### For Outline SOT-363

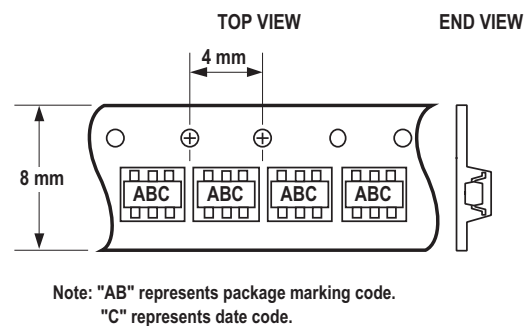



## Tape Dimensions and Product Orientation For Outline SOT-23

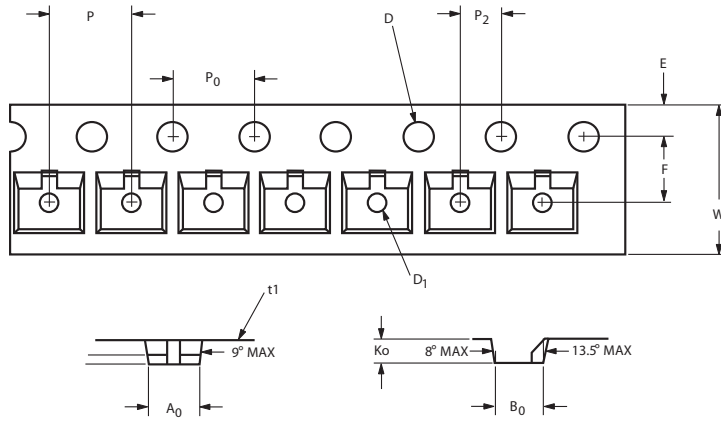

DESCRIPTION		SYMBOL	SIZE (mm)	SIZE (INCHES)
CAVITY	LENGTH	$A_0$	$3.15 \pm 0.10$	$0.124 \pm 0.004$
	WIDTH	$B_0$	$2.77 \pm 0.10$	$0.109 \pm 0.004$
	DEPTH	$K_0$	$1.22 \pm 0.10$	$0.048 \pm 0.004$
	PITCH	$P$	$4.00 \pm 0.10$	$0.157 \pm 0.004$
	BOTTOM HOLE DIAMETER	$D_1$	$1.00 + 0.05$	$0.039 \pm 0.002$
PERFORATION	DIAMETER	$D$	$1.50 + 0.10$	$0.059 + 0.004$
	PITCH	$P_0$	$4.00 \pm 0.10$	$0.157 \pm 0.004$
	POSITION	$E$	$1.75 \pm 0.10$	$0.069 \pm 0.004$
CARRIER TAPE	WIDTH	$W$	$8.00 + 0.30 - 0.10$	$0.315 + 0.012 - 0.004$
	THICKNESS	$t_1$	$0.229 \pm 0.013$	$0.009 \pm 0.0005$
DISTANCE BETWEEN CENTERLINE	CAVITY TO PERFORATION (WIDTH DIRECTION)	$F$	$3.50 \pm 0.05$	$0.138 \pm 0.002$
	CAVITY TO PERFORATION (LENGTH DIRECTION)	$P_2$	$2.00 \pm 0.05$	$0.079 \pm 0.002$

## For Outline SOT-143

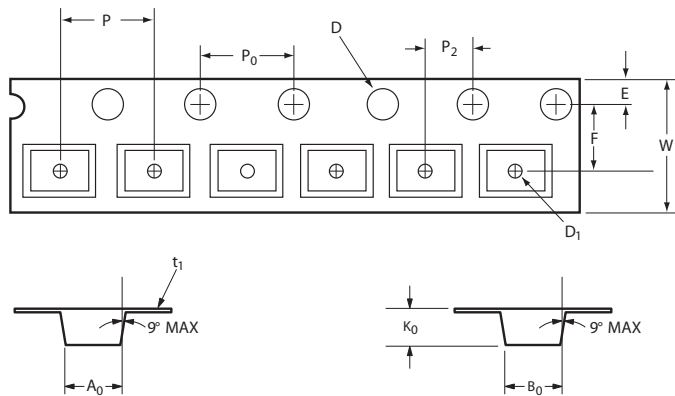

DESCRIPTION		SYMBOL	SIZE (mm)	SIZE (INCHES)
CAVITY	LENGTH	$A_0$	$3.19 \pm 0.10$	$0.126 \pm 0.004$
	WIDTH	$B_0$	$2.80 \pm 0.10$	$0.110 \pm 0.004$
	DEPTH	$K_0$	$1.31 \pm 0.10$	$0.052 \pm 0.004$
	PITCH	$P$	$4.00 \pm 0.10$	$0.157 \pm 0.004$
	BOTTOM HOLE DIAMETER	$D_1$	$1.00 + 0.25$	$0.039 + 0.010$
PERFORATION	DIAMETER	$D$	$1.50 + 0.10$	$0.059 + 0.004$
	PITCH	$P_0$	$4.00 \pm 0.10$	$0.157 \pm 0.004$
	POSITION	$E$	$1.75 \pm 0.10$	$0.069 \pm 0.004$
CARRIER TAPE	WIDTH	$W$	$8.00 + 0.30 - 0.10$	$0.315 + 0.012 - 0.004$
	THICKNESS	$t_1$	$0.254 \pm 0.013$	$0.0100 \pm 0.0005$
DISTANCE	CAVITY TO PERFORATION (WIDTH DIRECTION)	$F$	$3.50 \pm 0.05$	$0.138 \pm 0.002$
	CAVITY TO PERFORATION (LENGTH DIRECTION)	$P_2$	$2.00 \pm 0.05$	$0.079 \pm 0.002$

**Tape Dimensions and Product Orientation**  
**For Outlines SOT-323, -363**

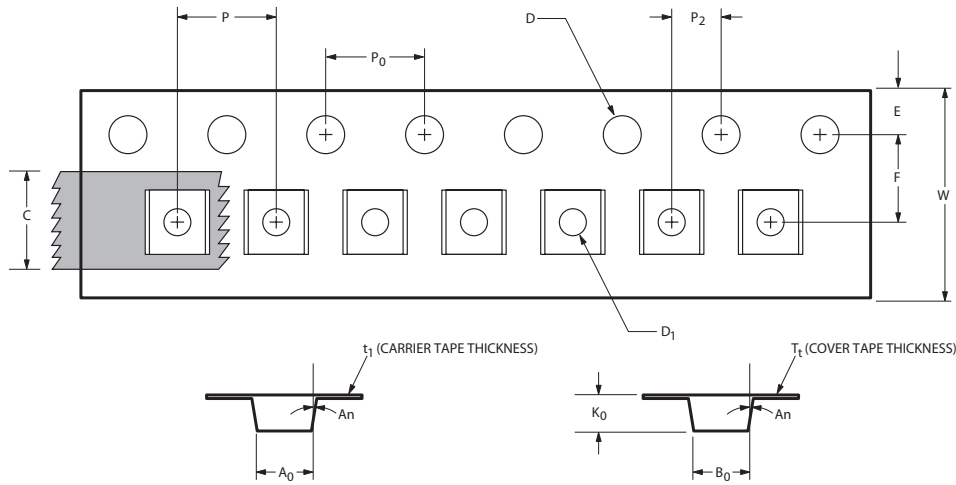

	DESCRIPTION	SYMBOL	SIZE (mm)	SIZE (INCHES)
CAVITY	LENGTH	$A_0$	$2.40 \pm 0.10$	$0.094 \pm 0.004$
	WIDTH	$B_0$	$2.40 \pm 0.10$	$0.094 \pm 0.004$
	DEPTH	$K_0$	$1.20 \pm 0.10$	$0.047 \pm 0.004$
	PITCH	$P$	$4.00 \pm 0.10$	$0.157 \pm 0.004$
	BOTTOM HOLE DIAMETER	$D_1$	$1.00 + 0.25$	$0.039 + 0.010$
	PERFORATION	DIAMETER	$D$	$1.55 \pm 0.05$
PITCH		$P_0$	$4.00 \pm 0.10$	$0.157 \pm 0.004$
POSITION		$E$	$1.75 \pm 0.10$	$0.069 \pm 0.004$
CARRIER TAPE	WIDTH	$W$	$8.00 \pm 0.30$	$0.315 \pm 0.012$
	THICKNESS	$t_1$	$0.254 \pm 0.02$	$0.0100 \pm 0.0008$
COVER TAPE	WIDTH	$C$	$5.4 \pm 0.10$	$0.205 \pm 0.004$
	TAPE THICKNESS	$T_t$	$0.062 \pm 0.001$	$0.0025 \pm 0.00004$
DISTANCE	CAVITY TO PERFORATION (WIDTH DIRECTION)	$F$	$3.50 \pm 0.05$	$0.138 \pm 0.002$
	CAVITY TO PERFORATION (LENGTH DIRECTION)	$P_2$	$2.00 \pm 0.05$	$0.079 \pm 0.002$
ANGLE	FOR SOT-323 (SC70-3 LEAD)	$A_n$	$8^\circ\text{C MAX}$	
	FOR SOT-363 (SC70-6 LEAD)	$A_n$	$10^\circ\text{C MAX}$	

For product information and a complete list of distributors, please go to our web site: [www.avagotech.com](http://www.avagotech.com)

Avago, Avago Technologies, and the A logo are trademarks of Avago Technologies in the United States and other countries. Data subject to change. Copyright © 2005-2010 Avago Technologies. All rights reserved. Obsoletes 5989-4020EN AV02-0533EN - April 14, 2010

