

KSS Series Subminiature Side Actuated Tact Switch for SMT



Features/Benefits

- Low profile of 1.6 mm
- Excellent tactile feel
- High shear force
- Range of actuation forces
- Large flat top
- Redundant contacts option
- Date code marking
- IP 40 sealed
- RoHS compliant and compatible

Typical Applications

- Cellular phone
- PDA, pagers
- Industrial electronics
- Health diagnostic electronics

Specification

FUNCTION: momentary action
CONTACT ARRANGEMENT: N.O.
TERMINALS: Gullwing / 3-Way type for SMT
IP40 sealed

Mechanical

Type	Operating force Newtons (grams)	Operating life (operations)	Travel
KSS221G	2.0 (200) ± 25%	100,000	0,3 ± 0,15
KSS231G	2.5 (250) ± 20%	100,000	0,3 ± 0,10
KSS233W	2.5 (200) ± 25%	100,000	0,3 ± 0,15
KSS241G	4.0 (400) ± 25%	100,000	0,3 ± 0,15

NOTE: Specifications listed above are for switches with standard options.
For information on specific and custom switches, consult Customer Service Center.

Electrical

	Silver	Gold
MAXIMUM POWER:	1 VA	0.2 VA
MAXIMUM VOLTAGE:	32 VDC	32 VDC
MAXIMUM CURRENT:	50 mA	10 mA
MINIMUM CURRENT:	1 mA	1 mA
DIELECTRIC STRENGTH:	≥ 250 VDC	
CONTACT RESISTANCE:	≤ 100 mΩ	
INSULATION RESISTANCE (100 VDC):	≥ 10 ⁹ Ω	
BOUNCE TIME:	≤ 3 ms	

Environmental

	Silver	Gold
OPERATING TEMPERATURE:	-40°C to 85°C	-40°C to 125°C
STORAGE TEMPERATURE:	-55°C to 85°C	-55°C to 125°C

Process

SOLDERING: Compatible with the lead free soldering profile.

Packaging

Switches are delivered in tape and reels of 3,000 pieces. The reel diameter is 330mm (12.992 x .15). The tape dimensions conform to the EIA-RS-481 and CE-2863 norms.

How To Order

Our easy build-a-switch concept allows you to mix and match options to create the switch you need. To order, select desired option from each category and place it in the appropriate box.

However, please note that all the combinations of these options are not feasible.

For any part number different from those listed above, please consult your local ITT representative.

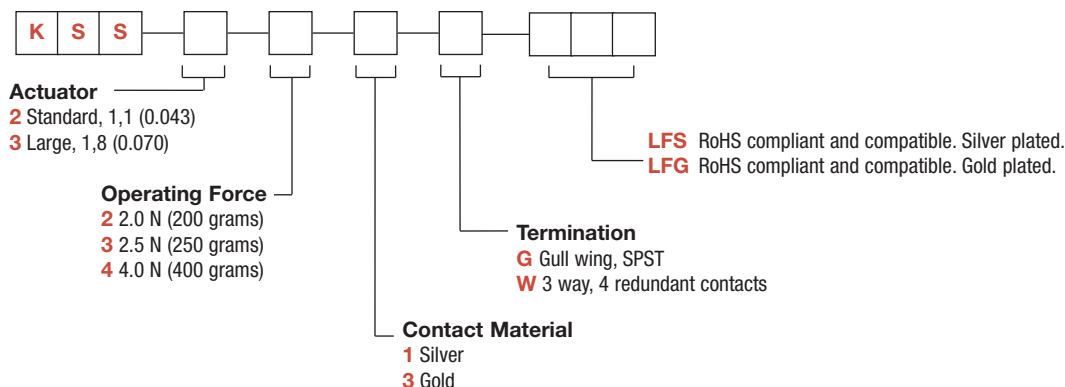

KSS Series Subminiature Side Actuated Tact Switch for SMT

KSS



KSS221G

Each piece is date code printed:
1st Line: 9308 = Year 1999, 308 day in the year
2nd Line: 221XA = Manufacturing code.

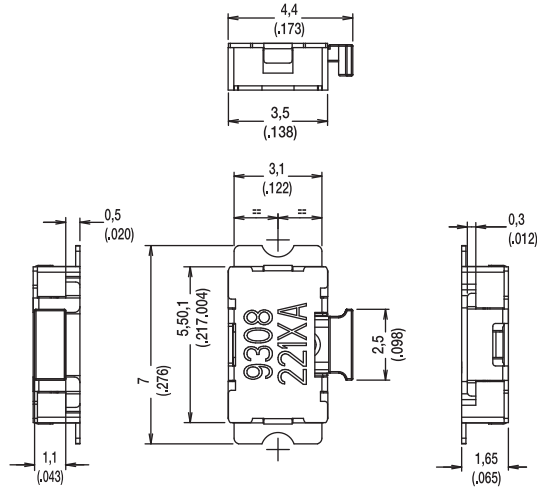

ACTUATOR

2 STANDARD, 1,1 (0.043)

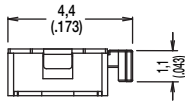

3 LARGE, 1,8 (0.070)

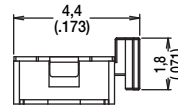

TERMINATION

G GULLWING

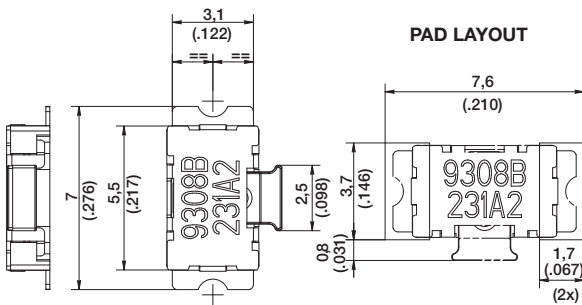

W 3 WAY, 4 REDUNDANT CONTACTS

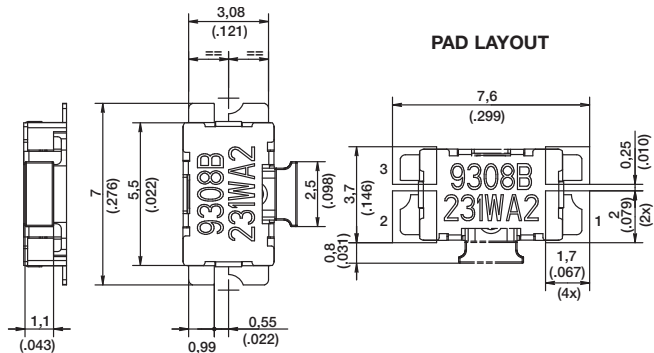

TAPE & REEL

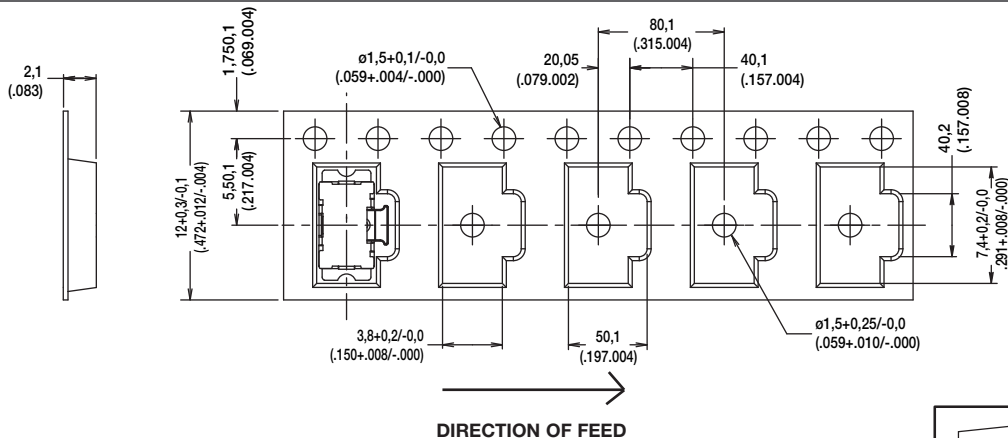

DIRECTION OF FEED



Dimensions shown in: mm (inch)
Specifications and dimensions subject to change

www.ittcannon.com



Tactile Switches

B