

1 2 3 4 5 6

A

B

C

D

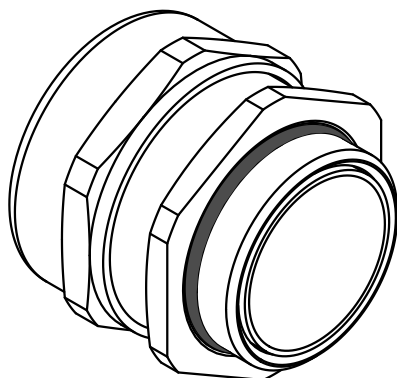
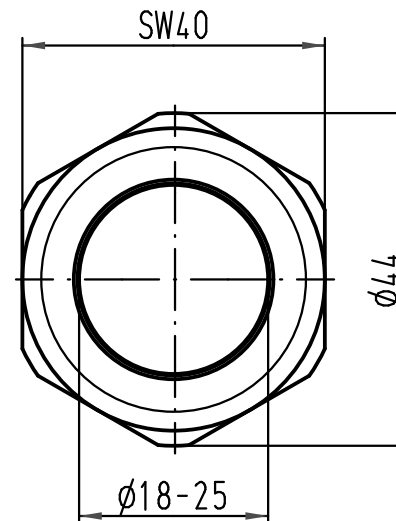
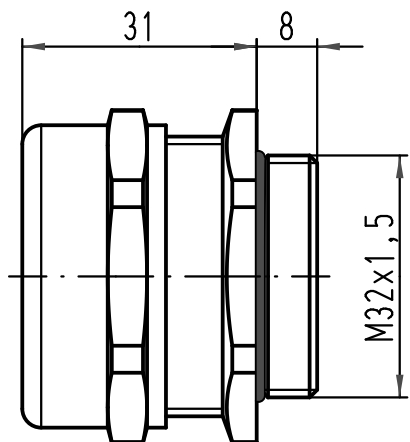

All Dimensions in mm Original Size DIN A 4			Techn. Character.			Nicht tolerierte Maße/ Free size tolerances			
				Dat.	Name	Maßstab/ Scale  1:1	Kabelverschraubung Metall M32x1,5 cable gland metal		
			Detail.	28.05.10	Go				
			Insp.		Sch				
			Stand.						
A			HARTING Electric GmbH & Co. KG				TB 19 00 000 5096		
Mod.	Dat.	Name	D-32339 Espelkamp						
							Sub. TB 19 00 000 509. v. 26.10.01		Blatt/ page