

LPC2478-STK and LPC2478-STK-MICTOR
development boards

User's Manual

Document revision C, October 2012
Copyright(c) 2009, OLIMEX Ltd, All rights reserved

INTRODUCTION:

LPC-2478STK is a starter kit which uses MCU LPC2478 from NXP. This powerful MCU supports various serial interfaces such as USB host, USB device, UART, CAN, etc. Additionally, you will find also audio input and output as well as MP3 decoder, digital accelerometer, JTAG, Ethernet, touchscreen TFT display and SD/MMC card connector on this board. All this along with the ARM7TDMI-S™ architecture and uC Linux allow you to build a diversity of powerful applications to be used in a wide range of situations.

BOARD FEATURES:

- MCU: LPC2478
- LCD 3.5" 320x 240 24bit color TFT with backlight and touchscreen
- MP3 decoder DSP + codec VS1002D
- 3-axis digital accelerometer with 11-bit accuracy
- 64 MB SDRAM
- USB host connector
- USB device connector
- IrDA transceiver (optional)
- MICTOR Trace connector (optional)
- PS2 keyboard connector
- 100Mbit Ethernet
- CAN driver and connector
- RS232 with ICSP control
- SD/MMC card connector
- JTAG connector
- Reset button and circuit
- 2 buttons
- 1 trim pot
- UEXT connector
- Audio IN
- Audio OUT
- RTC battery
- FR-4, 1.5 mm, red soldermask, component print
- Dimensions: 134.6x101.5mm (5.3x4.0")

ELECTROSTATIC WARNING:

The LPC-2478STK board is shipped in protective anti-static packaging. The board must not be subject to high electrostatic potentials. General practice for working with static sensitive devices should be applied when working with this board.

BOARD USE REQUIREMENTS:

Cables: You will need different cables depending on the used programming/debugging tool. If you use Olimex's ARM-JTAG, you will need a LPT cable. If you use ARM-USB-OCD or ARM-USB-TINY, you will need USB A-B cable. If you use a software

programmer such as FlashMagic, you may need RS232 or other cables.

Hardware: Programmer/Debugger – **ARM-JTAG, ARM-USB-TINY** or **ARM-USB-OCD** or other compatible programming/debugging tool.

Software: The board comes pre-loaded with Uboot and the CD contains ucLinux image you can copy to USB flash disk and boot. You can use GCC or other commercial ARM compiler if you want to develop without ucLinux RTOS.

PROCESSOR FEATURES:

LPC-2478STK board use MCU **LPC2478** from NXP with these features:

- ARM7TDMI-S processor, running at up to 72 MHz.
- 512 kB on-chip flash program memory with In-System Programming (ISP) and In-Application Programming (IAP) capabilities. Flash program memory is on the ARM local bus for high performance CPU access.
- 98 kB on-chip SRAM includes:
 - 64 kB of SRAM on the ARM local bus for high performance CPU access.
 - 16 kB SRAM for Ethernet interface. Can also be used as general purpose SRAM.
 - 16 kB SRAM for general purpose DMA use also accessible by the USB.
 - 2 kB SRAM data storage powered from the RTC power domain.
- LCD controller, supporting both Super-Twisted Nematic (STN) and Thin-Film Transistors (TFT) displays.
 - Dedicated DMA controller.
 - Selectable display resolution (up to 1024 × 768 pixels).
 - Supports up to 24-bit true-color mode.
- Dual Advanced High-performance Bus (AHB) system allows simultaneous Ethernet DMA, USB DMA, and program execution from on-chip flash with no contention.
- EMC provides support for asynchronous static memory devices such as RAM, ROM and flash, as well as dynamic memories such as Single Data Rate SDRAM.
- Advanced Vectored Interrupt Controller (VIC), supporting up to 32 vectored interrupts.
- General Purpose AHB DMA controller (GPDMA) that can be used with and SD/MMC interface as well as for memory-to-memory transfers.
- Serial Interfaces:
 - Ethernet MAC with MII/RMII interface and associated DMA controller. These functions reside on an independent AHB.

- USB 2.0 full-speed dual-port device/host/OTG controller with on-chip PHY and associated DMA controller.
 - Four UARTs with fractional baud rate generation, one with modem control I/O, one with IrDA support, all with FIFO.
 - CAN controller with two channels.
 - SPI controller.
 - Two SSP controllers, with FIFO and multi-protocol capabilities. One is an alternate for the SPI port, sharing its interrupt. SSPs can be used with the GPDMA controller.
 - Three I2C-bus interfaces (one with open-drain and two with standard port pins).
 - I2S (Inter-IC Sound) interface for digital audio input or output. It can be used with the GPDMA.
- Other peripherals:
 - SD/MMC memory card interface.
 - 160 General purpose I/O pins with configurable pull-up/down resistors.
 - 10-bit ADC with input multiplexing among 8 pins.
 - 10-bit DAC.
 - Four general purpose timers/counters with 8 capture inputs and 10 compare outputs. Each timer block has an external count input.
 - Two PWM/timer blocks with support for three-phase motor control. Each PWM has an external count inputs.
 - Real-Time Clock (RTC) with separate power domain. Clock source can be the RTC oscillator or the APB clock.
 - 2 kB SRAM powered from the RTC power pin, allowing data to be stored when the rest of the chip is powered off.
 - WatchDog Timer (WDT). The WDT can be clocked from the internal RC oscillator, the RTC oscillator, or the APB clock.
 - Single 3.3 V power supply (3.0 V to 3.6 V).
 - 4 MHz internal RC oscillator trimmed to 1 % accuracy that can optionally be used as the system clock.
 - Three reduced power modes: idle, sleep, and power-down.
 - Four external interrupt inputs configurable as edge/level sensitive. All pins on port 0 and port 2 can be used as edge sensitive interrupt sources.
 - Processor wake-up from Power-down mode via any interrupt able to operate during Power-down mode (includes external interrupts, RTC interrupt, USB activity, Ethernet wake-up interrupt, CAN bus activity, port 0/2 pin interrupt).
 - Two independent power needed features.
 - Each peripheral has its own clock divider for further power saving. These dividers help reduce active power by 20 % to 30 %.
 - Brownout detect with separate thresholds for interrupt and forced reset.

- On-chip power-on reset.
- On-chip crystal oscillator with an operating range of 1 MHz to 24 MHz.
- On-chip PLL allows CPU operation up to the maximum CPU rate without the need for a high frequency crystal. May be run from the main oscillator, the internal RC oscillator, or the RTC oscillator.
- Boundary scan for simplified board testing.
- Versatile pin function selections allow more possibilities for using on-chip peripheral functions.
- Standard ARM test/debug interface for compatibility with existing tools.
- Emulation trace module supports real-time trace.

BLOCK DIAGRAM:

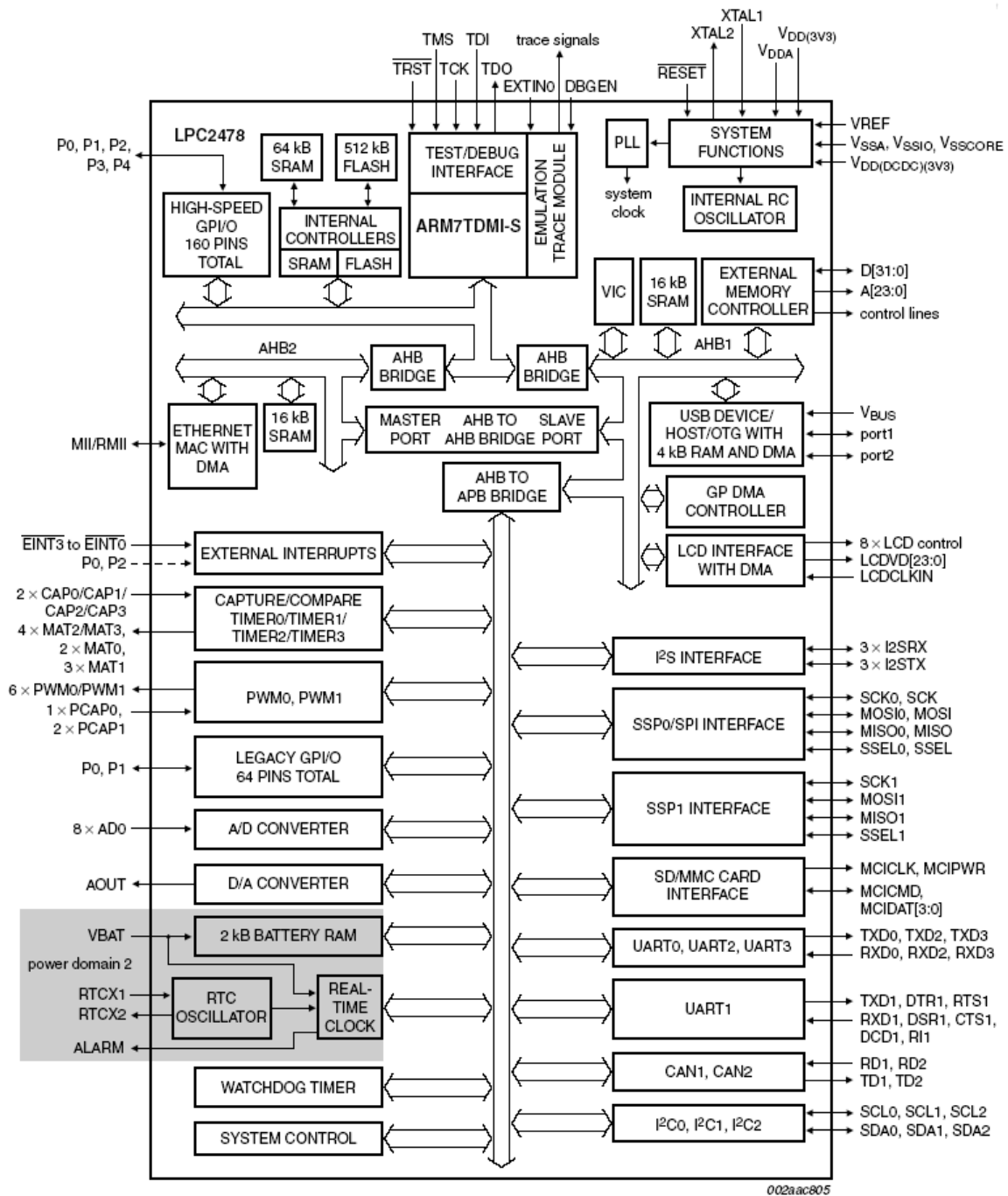

Fig 1. LPC2478 block diagram

MEMORY MAP:

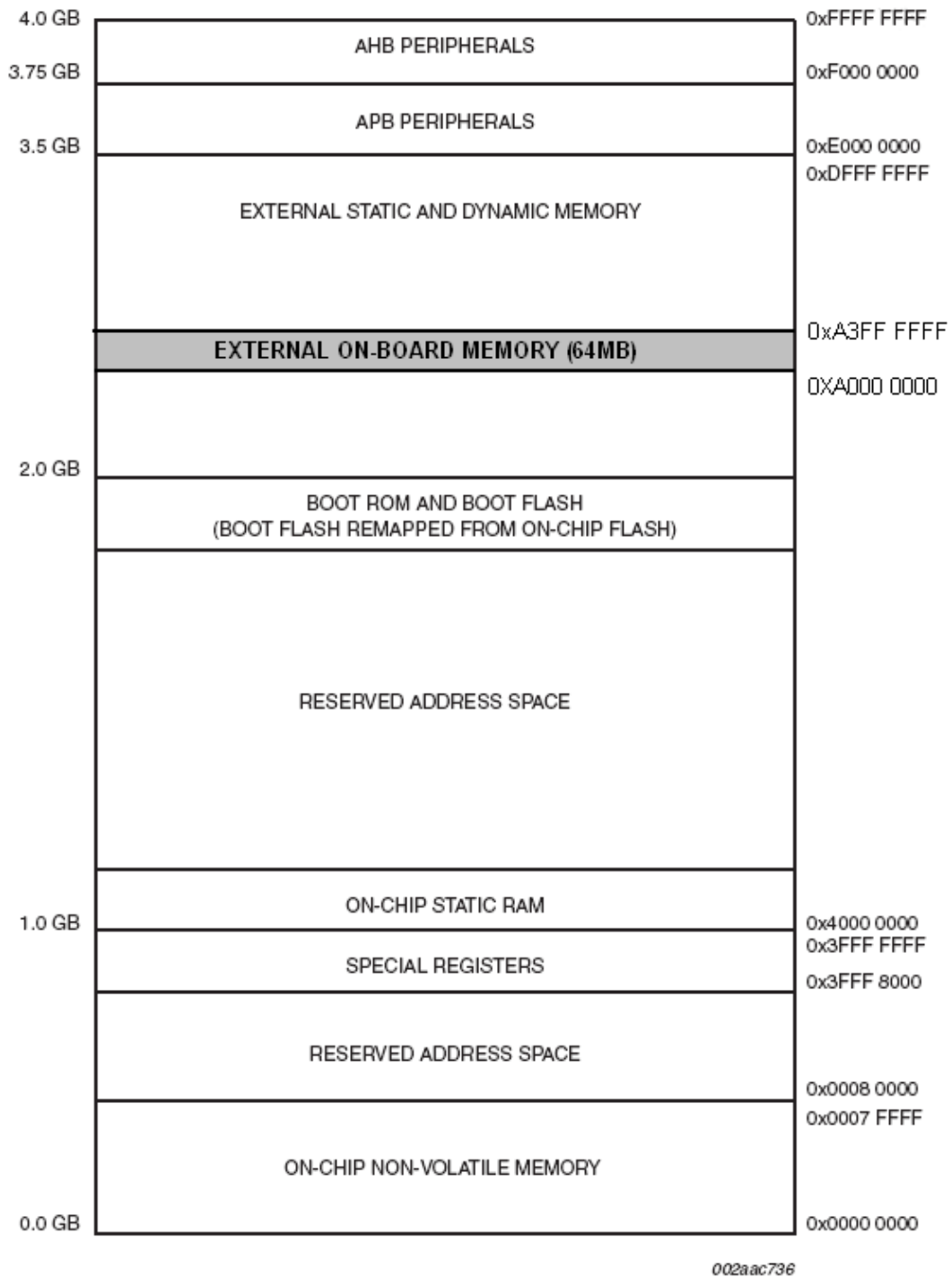
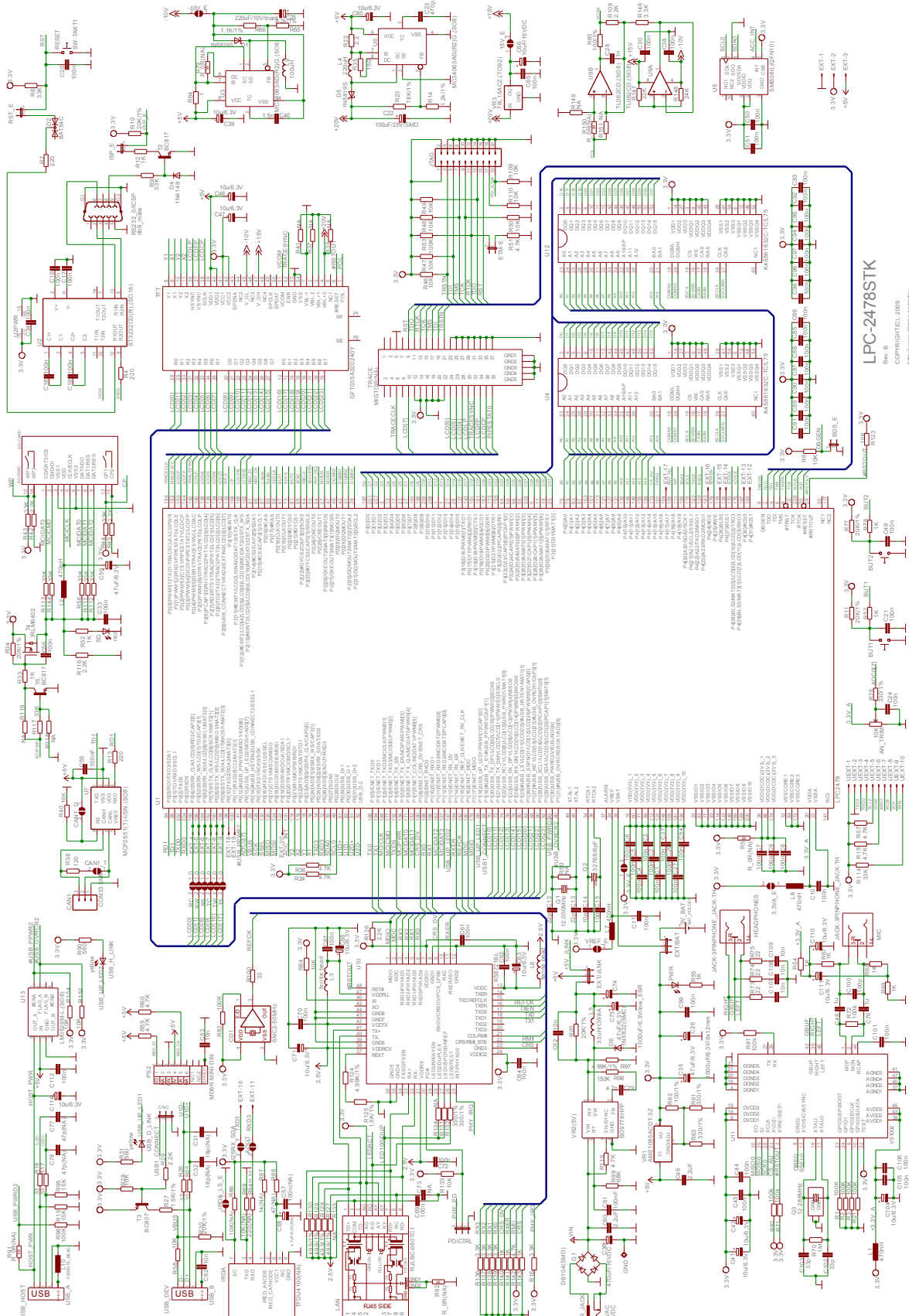

Fig 4. LPC2478 memory map

SCHEMATIC:



LPC-2478S-TK

Rev. B
COPYRIGHT (C) 2009
http://www.omron.com/ky

BOARD LAYOUT:

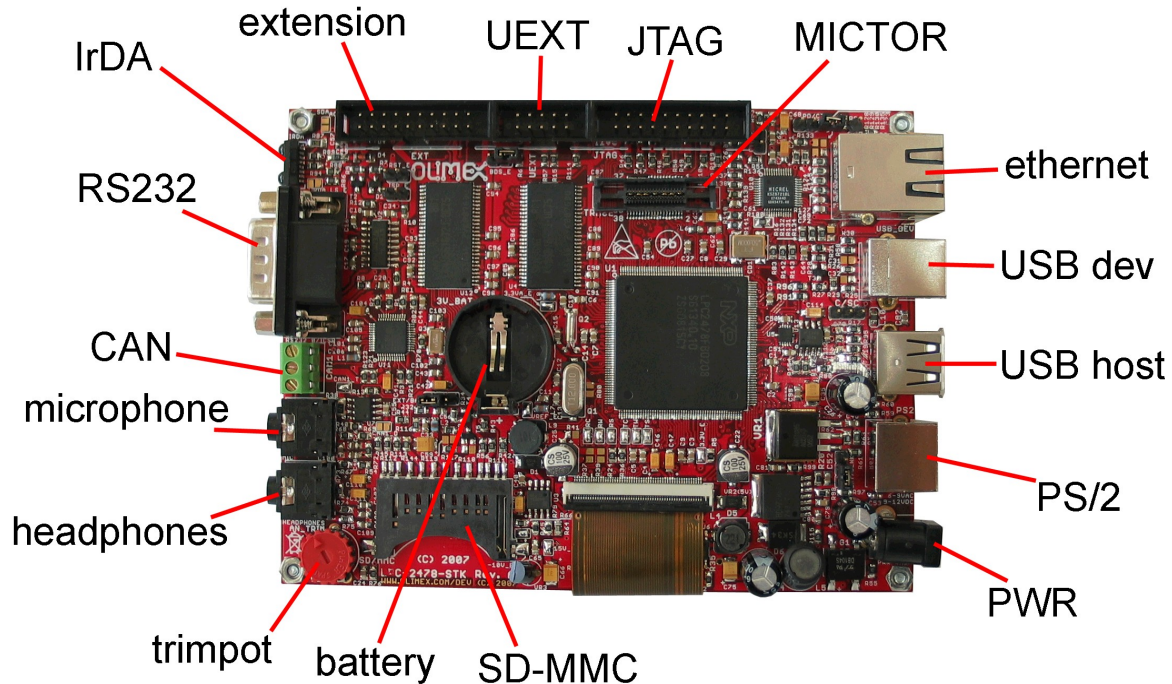

POWER SUPPLY CIRCUIT:

LPC-2478STK is powered by +(9-12)VDC/6VAC applied at the power jack. LPC-2478STK could also be powered by a battery (CR2032, Li, 3V) but this battery only powers the 2KB internal SRAM and the RTC (Real Time Clock).

The consumption of LPC-2478STK varies depending on the supplied power but at +10VDC it is about 250mA.

RESET CIRCUIT:

LPC-2478STK reset circuit is made with R68(47k) pull-up, capacitor C20(100nF) and the RST button.

CLOCK CIRCUIT:

Quartz crystal 12 MHz is connected to LPC2478 pin 44 (XTAL1) and pin 46 (XTAL2).

Quartz crystal 32.768 kHz is connected to LPC2478 pin 34 (RTX1) and pin 36 (RTX2) and supplies the internal Real Time Clock.

JUMPER DESCRIPTION:



CAN_D

CAN Disable. If this jumper is closed, the CAN is disabled.
Default state is open.



CAN_T

This jumper assures correct work of the CAN. At each end of the bus it should be closed. This means that if you have only two devices with CAN, the jumpers of both devices should be closed. If you have more than two devices, only the two end-devices should be closed.

Default state is closed.



-10V_E

This jumper, when closed, supplies -10 V voltage to the on board LCD panel.

Default state is closed.



15V_E

This jumper, when closed, supplies 15 V voltage to the on board LCD panel.

Default state is closed.



3.3V_E

This jumper, when closed, supplies 3.3 V voltage to the VDD1-10 pins of the MCU.

Default state is closed.



3.3VA_E

This jumper, when closed, supplies 3.3 V voltage to the VDDA pin of the MCU.

Default state is closed.



VREF_E

This jumper, when closed, supplies 3.3 V reference voltage to the VREF pin of the MCU.

Default state is closed.



IRDA_LS_E

IRDA_LowSpeed_Enable jumper – opened if there is no IrDA module or it is disabled.

Default state is opened if your board doesn't have an IrDA connector.



I2SRX_SDA

IrDA TX input pin jumper – opened if there is no IrDA module or it is disabled.

Default state is opened if your board doesn't have an IrDA connector.



AOUT

IrDA RX output pin jumper – opened if there is no IrDA module or it is disabled.

Default state is opened if your board doesn't have an IrDA connector.



RC

This jumper, when closed, outputs the LCD[0] signal from the **LPC2478** to the TFT display. If it is open, pin 168 of the **LCP2478** is connected to EXT-4.

Default state is closed.



RW

This jumper, when closed, outputs the LCD[1] signal from the **LPC2478** to the TFT display. If it is open, pin 166 of the **LCP2478** is connected to EXT-5.

Default state is closed.



RS

This jumper, when closed, outputs the LCD[8] signal from the **LPC2478** to the TFT display. If it is open, pin 164 of the **LCP2478** is connected to EXT-6.

Default state is closed.



TC

This jumper, when closed, outputs the LCD[9] signal from the **LPC2478** to the TFT display. If it is open, pin 162 of the **LCP2478** is connected to EXT-7.

Default state is closed.



TW

This jumper, when closed, outputs the LCD[16] signal from the **LPC2478** to the TFT display. If it is open, pin 160 of the **LCP2478** is connected to EXT-8.

Default state is closed.



TS

This jumper, when closed, outputs the LCD[17] signal from the **LPC2478** to the TFT display. If it is open, pin 158 of the **LCP2478** is connected to EXT-9.

Default state is closed.



ISP_E

If you put this jumper, you enable the ISP (In-System Programming). This is used when you want external software to program the **LCP2478**. This jumper is used in combination with the RST_E jumper.

Default state is open.



RST_E

If you put this jumper, you enable external software to control the Reset signal to the processor. This is used when you want external software to program the **LCP2478**. This jumper is used in combination with the ISP_E jumper.

Default state is open.



ETM_E

If you put this jumper, you enable the MICTOR Trace connector.
Default state is open.



BDS_E

Boundary scan enable.
Default state is open.



C/SC

This jumper controls the USB device interface.
If 1-2 are shorted, the USB is always enabled.

1 2 3



If 2-3 are shorted, the USB Enable is controlled by the MCU
LPC2478 signal USB1_CONNECT.

1 2 3

Default state is 2-3 shorted.



PD/CTRL

This jumper controls the PHY signal of the Ethernet controller.
If there is no jumper, the PHY is always enabled.

1 2 3



If 1-2 are shorted, the PHY is disabled

1 2 3



If 2-3 are shorted, the PHY is controlled by the LPC2478 signal
PHY_PD.

1 2 3

Default state is no jumper (opened).

EXT/JLINK



This jumper controls the JLINK +5V power line (pin19) of the JTAG
and the +5VDC power supply of the board.

3 2 1

If 1-2 are shorted, the JLINK +5V power line (pin19) from the JTAG
interface supplies the board with +5VDC.



If 2-3 are shorted, the board is supplied with +5VDC from the
+5VDC voltage regulator.

3 2 1

Default state is 2-3 shorted.

EXT/BAT



This jumper controls the VBAT signal of the LPC2478.

3 2 1

If 1-2 are shorted, the VBAT pin is supplied by an external
battery.



If 2-3 are shorted, the VBAT pin is supplied by the common
+3.3VDC power supply for the board.

3 2 1

Default state is 2-3 shorted.

INPUT/OUTPUT:

SD/MMC LED (red) with name **SD** connected to **SD/MMC** pin 4.

Power-on LED (red) with name **PWR** – this LED shows that +3.3V is applied to the board.

USB host LED (yellow) with name **USB_H_LINK** – connected to **LPC2478** pin 147 (P1[13]/ENET_RX_DV).

USB device LED (yellow) with name **USB_D_LINK** – connected to **LPC2478** pin 66 (P1[18]/USB_UP_LED1/PWM1[1]/CAP1[0]).

User button with name **BUT1** connected to **LPC2478** pin 67 (P2[19]/CLKOUT1).

User button with name **BUT2** connected to **LPC2478** pin 81 (P2[21]/#DYCS1).

Reset button with name **RESET** connected to **LPC2478** pin 35 (#RESET).

Trimpot with name **AN_TRIM** connected to **LPC2478** pin 45 (P0[13]/USB_UP_LED2/MOSI1/AD0[7]).

TFT touchscreen display – 3.5", 320x200, 24-bit color.

EXTERNAL CONNECTORS DESCRIPTION:

JTAG:

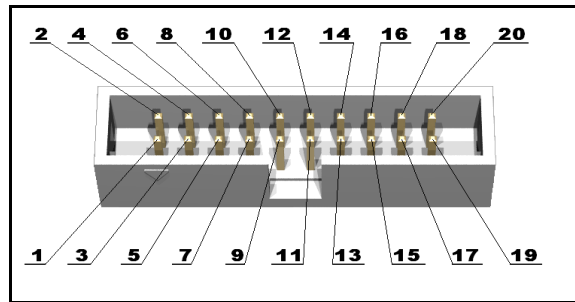

Pin #	Signal Name	Pin #	Signal Name
1	+3.3V	2	+3.3V
3	TRSTN	4	GND
5	TDI	6	GND
7	TMS	8	GND
9	TCK	10	GND
11	RTCK	12	GND
13	TDO	14	GND
15	RST	16	GND
17	GND	18	GND
19	+5V_JLINK	20	GND

TDI Input **Test Data In**. This is the serial data input for the shift register.

TDO Output **Test Data Out**. This is the serial data output for the shift register. Data is shifted out of the device on the negative edge of the TCK signal.

TMS Input **Test Mode Select**. The TMS pin selects the next state in the TAP state machine.

TCK Input **Test Clock**. This allows shifting of the data in, on the TMS and TDI pins. It is a positive edge triggered clock with the TMS and TCK signals that define the internal state of the device.

TRSTN Input **Test Reset N**. This signal resets the JTAG controller.

RTCK Output **Return Clock**. This is a synchronization signal which the JTAG connector uses to acknowledge it is ready to receive/transmit.

JTAG is used to to program and debug the MCU.

RS232:

Pin #	Signal Name
1	NC
2	RXD0
3	TXD0
4	NC
5	GND
6	RST
7	NC
8	ISP_E
9	NC

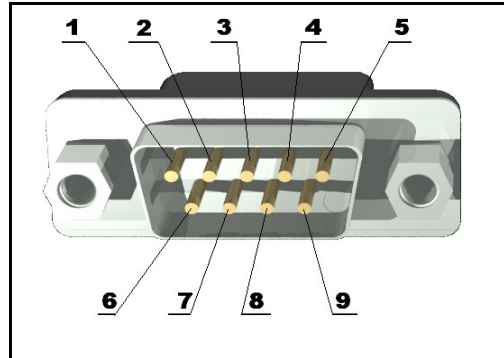

The RS232 in LPC2478-STK and LPC2478-STK is configured as DTE. Note that in order to establish connection to another DTE device (e.g. personal computer) you will need a null modem cable

TXD0 Output **Transmit Data**. This is the asynchronous serial data output (RS232) for the shift register on the UART controller. (This pin is input for the RS232 and input for the LPC2478)

RXD0 Input **Receive Data**. This is the asynchronous serial data input (RS232) for the shift register on the UART controller. (This pin is output for the RS232 and input for the LPC2478)

RST Input **Reset**. When you use external software to program the LPC2478, this software uses the RS232 to connect to the device and if the jumper RST_E is put, than through this RST pin the software controls the #RESET pin of the MCU. (This pin is output for the RS232 and input for the LPC2478)

ISP_E Input **In-System Programming**. If you use external software to program the device, this pin enables the programming. A pre-condition to enable ISP is the ISP_E jumper to be put. (This pin is output for the RS232 and input for the LCP2478)

CAN:

Pin #	Signal Name
1	GND
2	CANL
3	CANH

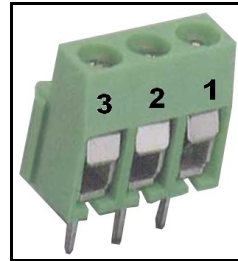

CANL and CANH are either differential input, or differential output depending on the function of the MCP2551 CAN controller (receiving or transmitting data).

PWR:

Pin #	Signal Name
1	Power Input
2	GND

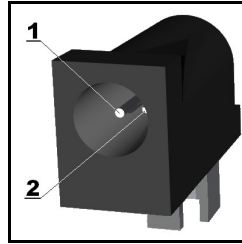

The power input should be +(9-12VDC)/6VAC.

Audio In:

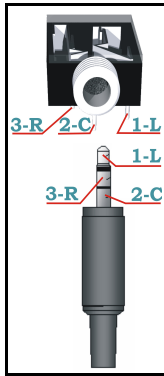

Pin #	Signal Name
1	NC
2	GND
3	MCP

MCP Input **Microphone Input**. This pin is input to the DSP codec VS1002D.

Audio Out:

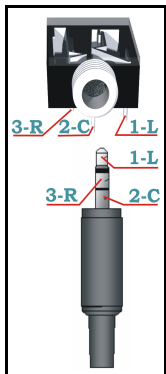

Pin #	Signal Name
1	LEFT
2	GBUF
3	RIGHT

LEFT Output **Left channel output**. This pin is output for the DSP codec VS1002D.

GBUF Output **Virtual ground for audio output**, 1.23 V nominal. This pin is output for the DSP codec VS1002D.

RIGHT Output **Right channel output**. This pin is output for the DSP codec VS1002D.

EXT:

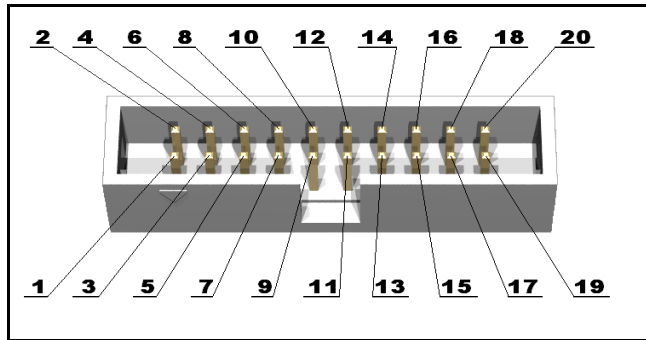

Pin #	Signal Name	Pin #	Signal Name
1	GND	2	+3.3V
3	+5V	4	P0[4]/I2SRX_CLK/LCD [0]/RD2/CAP2[0]
5	P0[5]/I2SRX_WS/LCD [1]/TD2/CAP2[1]	6	P0[6]/I2SRX_SDA/LCD [8]/SSEL1/MAT2[0]
7	P0[7]/I2STX_CLK/LCD [9]/SCK1/MAT2[1]	8	P0[8]/I2STX_WS/LCD [16]/MISO1/MAT2[2]
9	P0[9]/I2STX_SDA/LCD [17]/MOSI1/MAT2 [3]	10	TXD3
11	RXD3	12	P4[31]/#CS1
13	P4[30]/#CS0	14	P4[27]/BLS1
15	P4[26]/BLS0	16	P4[24]/#OE
17	P4[17]/A17	18	P0[10]/TXD2/SDA2/MAT3[0]
19	P0[11]/RXD2/SCL2/MAT3[1]	20	

UEXT:

Pin #	Signal Name
1	+3.3V
2	GND
3	TXD2
4	RXD2
5	SCL2
6	SDA2
7	MISO
8	MOSI
9	SCK
10	SSEL

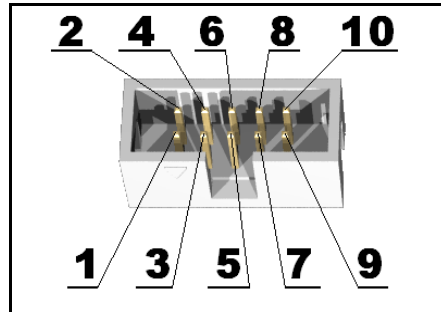

USB host:

Pin #	Signal Name
1	USB_PWRD2
2	U2D-
3	U2D+
4	GND

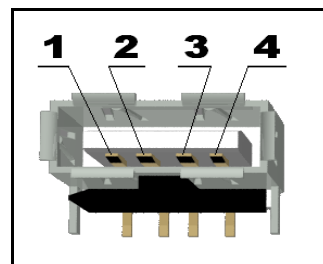

USB_PWRD2 Output USB Power. This signal is output from the processor and input for the USB host.

U2D-, U2D+ I/O This signals form the differential input/output depending on the direction of the data transfer.

USB device:

Pin #	Signal Name
1	VBUS
2	U1D-
3	U1D+
4	GND

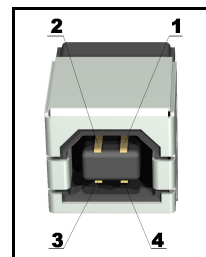

VBUS Output USB device power.

U1D-, U1D+ I/O This signals form the differential input/output depending on the direction of the data transfer.

LAN:

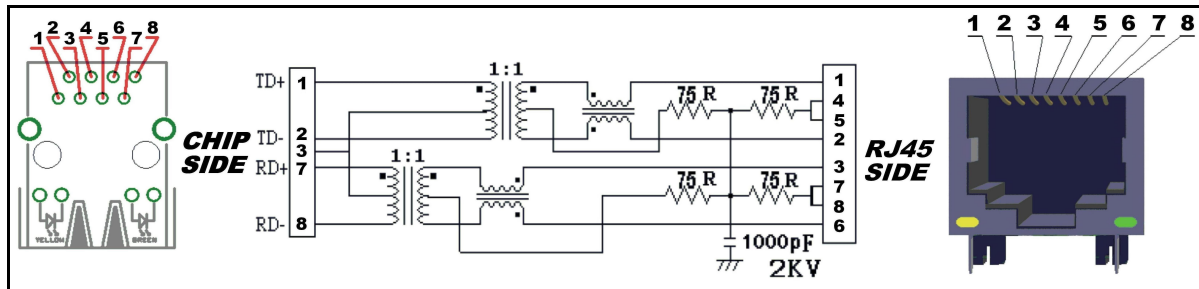

Pin #	Signal Name Chip Side	Pin #	Signal Name Chip Side
1	TD+	5	LED100/DUP
2	TD-	6	NC
3	2.5V	7	RD+
4	LEDACT	8	RD-

LED	Color	Usage
Right	Yellow	Activity
Left	Green	100Mbits/s (Half/Full duplex)

TD- Output Differential signal output. This signal is output from the MCU.

TD+ Output Differential signal output. This signal is output from the MCU.

RD- Input Differential signal input. This signal is input for the MCU.

RD+ Input Differential signal input. This signal is input for the MCU.

SD/MMC card slot:

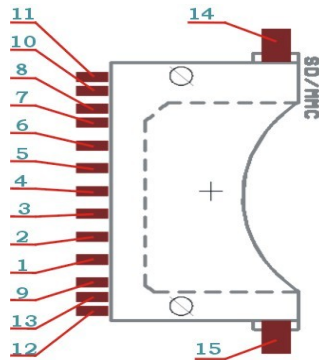

Pin #	Signal Name	Pin #	Signal Name
1	MCIDAT3	2	MCICMD
3	GND (VSS1)	4	VDD
5	MCICLK	6	GND (VSS2)
7	MCIDAT0	8	MCIDAT1
9	MCIDAT2	10	WP
11	-	12	-
13	CP	14	GND
15	GND		

MCIDAT0-3 I/O **Memory Card Interface Data 0-4**. These are the data lines for the SD/MMC connector. They could be both input and output for the MCU depending on the data flow direction.

MCICMD Output **Memory Card Interface Command**. This is a command sent from the processor to the memory card and as such it is output from the processor.

MCICLK Output **Memory Card Interface Clock**. This signal is output from the MCU and synchronizes the data transfer between the memory card and the MCU.

WP Input **Write Protect**. This signal is input for the MCU.

CP Input **Card Present**. This signal is input for the MCU.

PS2:

Pin #	Signal Name
1	KBO_IO
2	NC
3	GND
4	+5V
5	KBO_CLK
6	NC

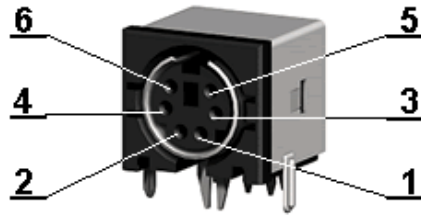

KBO_IO I/O **Keyboard Input/Output.** This is the data line between the keyboard and the MCU.

KBO_CLK Output **Keyboard Clock.** This is the synchronization clock between the keyboard and the MCU.

IrDA (optional chip):

Pin #	Signal Name
1	+3.3V
2	NC
3	GND/TXD3 - look at jumper I2SRX_SDA
4	NC/RXD3 - look at jumper AOUT
5	NC
6	+3.3V
7	NC 3.3V/GND - look at jumper IRDA_LS_E
8	GND

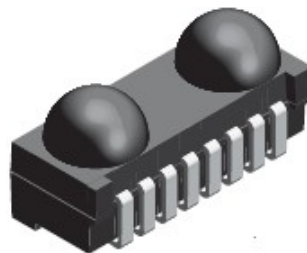

MICTOR TRACE (optional):

The MICTOR TRACE connector allows you to trace the execution of the programs.

MECHANICAL DIMENSIONS:

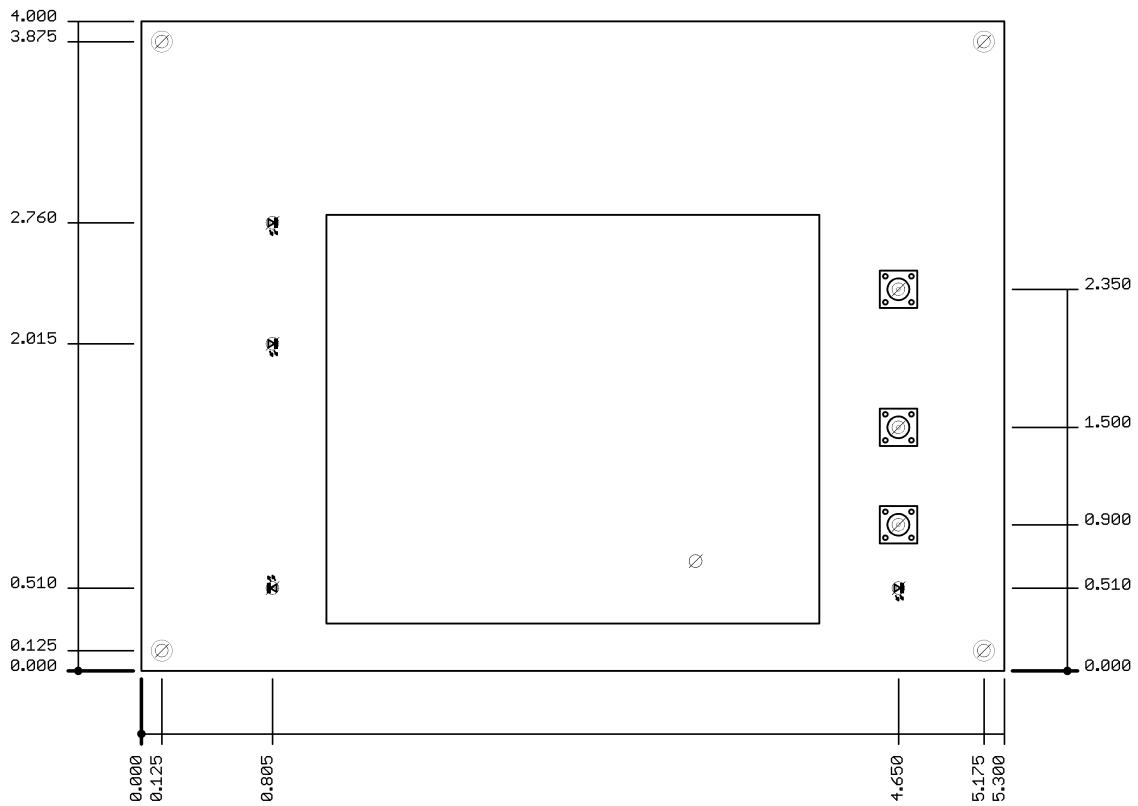

All measures are in inches.

AVAILABLE DEMO SOFTWARE:

LPC-2478STK is delivered pre-loaded with C Linux and the sources and binaries are on the accompanying CD.

ORDER CODE:

LPC-2478STK – assembled and tested (no kit, no soldering required)

How to purchase?

You can order directly from our e-shop or from any of our distributors.

Check our web <https://www.olimex.com/> for more info.



All boards produced by Olimex are RoHS compliant

Revision history:

REV.B	- created November 2009
REV.C	- released October 2012

Disclaimer:

© 2012 Olimex Ltd. Olimex®, logo and combinations thereof, are registered trademarks of Olimex Ltd. Other product names may be trademarks of others and the rights belong to their respective owners.

The information in this document is provided in connection with Olimex products. No license, express or implied or otherwise, to any intellectual property right is granted by this document or in connection with the sale of Olimex products.

It is possible that the pictures in this manual differ from the latest revision of the board.

The product described in this document is subject to continuous development and improvements. All particulars of the product and its use contained in this document are given by OLIMEX in good faith. However all warranties implied or expressed including but not limited to implied warranties of merchantability or fitness for purpose are excluded. This document is intended only to assist the reader in the use of the product. OLIMEX Ltd. shall not be liable for any loss or damage arising from the use of any information in this document or any error or omission in such information or any incorrect use of the product.

This evaluation board/kit is intended for use for engineering development, demonstration, or evaluation purposes only and is not considered by OLIMEX to be a finished end-product fit for general consumer use. Persons handling the product must have electronics training and observe good engineering practice standards. As such, the goods being provided are not intended to be complete in terms of required design-, marketing-, and/or manufacturing-related protective considerations, including product safety and environmental measures typically found in end products that incorporate such semiconductor components or circuit boards.

Olimex currently deals with a variety of customers for products, and therefore our arrangement with the user is not exclusive. Olimex assumes no liability for applications assistance, customer product design, software performance, or infringement of patents or services described herein.

THERE IS NO WARRANTY FOR THE DESIGN MATERIALS AND THE COMPONENTS USED TO CREATE THE PRODUCT THIS MANUAL IS WRITTEN FOR. THEY ARE CONSIDERED SUITABLE ONLY FOR THIS PRODUCT.