

ONE SIDE NO FEEDBACK

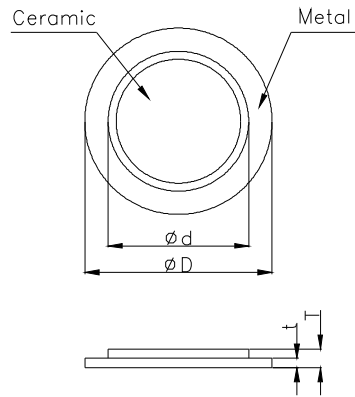

MODEL NO.	RESONANT FREQUENCY KHz	RESONANT IMPEDANCE max. Ω	CAPACITY $\pm 30 \square$ pF	DIMENSIONS				PLATE MATERIAL
				D mm	d mm	T mm	t mm	
MZ-50280B00	2.8	200	35000	50.0	25.0	0.43	0.20	Brass