

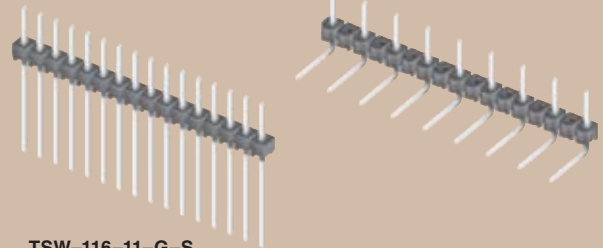

TSW-108-05-L-Q



TSW-116-11-G-S

(2,54mm) .100"

TSW, HTSW SERIES

# THROUGH-HOLE .025" SQ POST HEADER

**Mates with:**

SSW, SSQ, SSM, ESW, ESQ, BCS, BSW, CES, SLW, IDSD, IDSS, SMSD, SMSS

**SPECIFICATIONS**

For complete specifications see [www.samtec.com?TSW](http://www.samtec.com?TSW)

**TSW**

**Insulator Material:**  
Black Glass Filled Polyester  
**Terminal Material:**  
Phosphor Bronze  
**Plating:**  
Au or Sn over 50µ" (1,27µm) Ni



**Operating Temp Range:**  
-55°C to +125°C with Gold  
-55°C to +105°C with Tin

**Voltage Rating:**  
550 VAC mated with SSW;  
500 VAC mated with BCS or ESQ;  
450 VAC -RA/-RE mated with BCS or SSM  
**RoHS Compliant:**  
Yes  
**Lead-Free Solderable:**  
Wave Only

CURRENT RATING						
AMBIENT TEMP	TSW mated with					
	ESW	SSW	SLW	SSQ	SSM	BCS
20°C	6.9A	6.9A	7.1A	7.6A	6.9A	5.9A
40°C	6A	6.1A	6.2A	6.9A	6A	5.2A
60°C	5.3A	5.3A	5.8A	5.9A	5.3A	4.7A
95°C	3.5A	3.5A	3.7A	3.9A	3.5A	3A

6 POSITIONS (2x3) POWERED

**SPECIFICATIONS**

For complete specifications see [www.samtec.com?HTSW](http://www.samtec.com?HTSW)

**HTSW**

Same as TSW except:  
**Insulator Material:**  
Natural Liquid Crystal Polymer



**ALSO AVAILABLE**

Shunts. See SNT Series

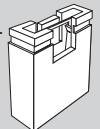

**Note:** Some lengths, styles and options are non-standard, non-returnable.

**TYPE STRIP**

TSW = Standard Strip

HTSW = Hi-Temp Strip

**PIN CENTERS**

-1 = .100" (2,54mm) Centers, All Positions Filled

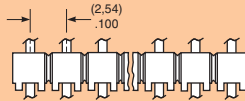

-2 = .200" (5,08mm) Centers, Every Other Position Filled

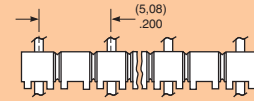

**NO. PINS PER ROW**

**Straight Pin Versions**

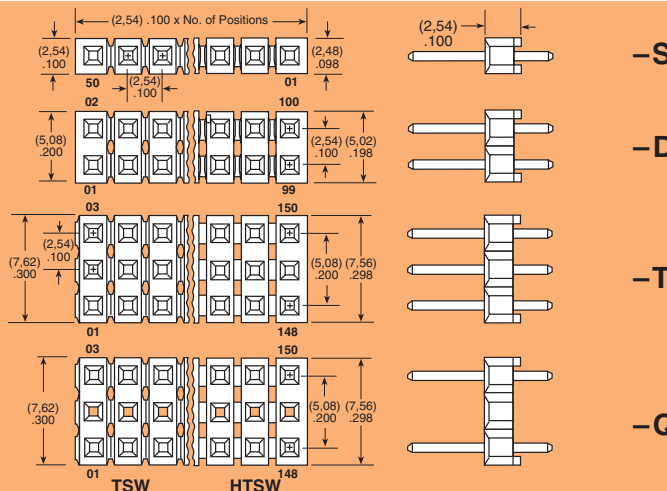

01 thru 50  
= .100" (2,54mm) Center Version

**Right Angle Versions**

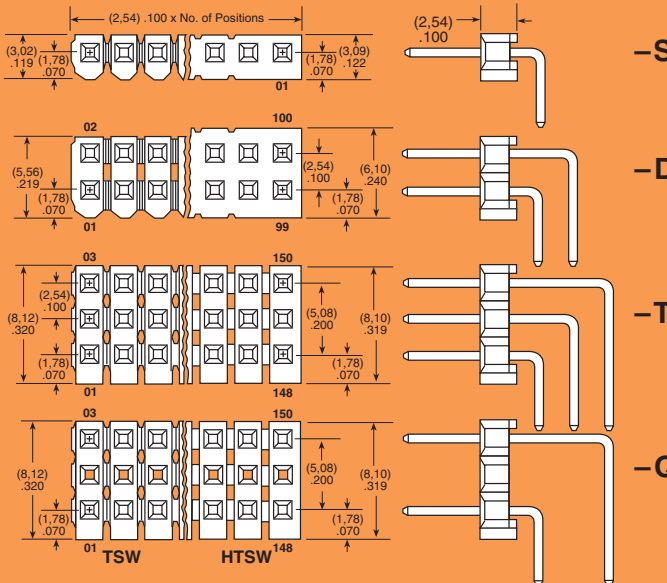

02 thru 25  
= .200" (5,08mm) Center Version

**APPLICATIONS**

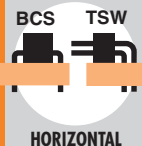

Due to technical progress, all designs, specifications and components are subject to change without notice.

[WWW.SAMTEC.COM](http://WWW.SAMTEC.COM)

TSW-109-10-F-D-RA

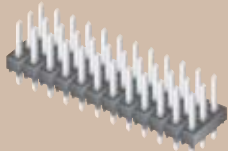

TSW-112-07-G-T

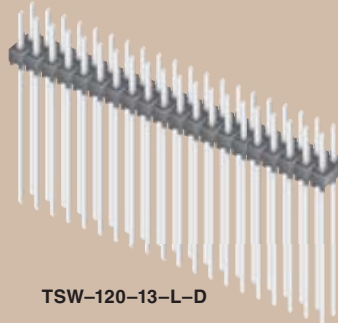

TSW-120-13-L-D

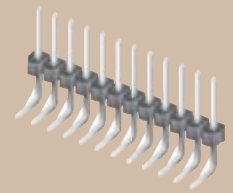

TSW-112-16-T-S-RE

**LEAD STYLE**

**PLATING OPTION**

**ROW OPTION**

**OTHER OPTIONS**

**-F**

= Gold flash on post, Matte Tin on tail

**-L**

= 10µ" (0,25µm) Gold on post, Matte Tin on tail

**-G**

= 10µ" (0,25µm) Gold on post, Gold flash on balance

**-T**

= Matte Tin

**-SS**

= 30µ" (0,76µm) Gold stripe on contact area, Gold flash to tip, Matte Tin on tail (Mates with SSW, SSQ, SSM, ESW, ESQ, BCS only) (Straight lead styles -07, -08, -09 and Right Angle (-RA) -08 only)

Specify -SS for cost-effective heavy Gold where it counts!

Note: Other Gold plating options available. Contact Samtec.

**-S**

= Single Row

**-D**

= Double Row

**-T**

= Triple Row

**-Q**

= Double Row (5,08mm) .200" row space

**-RA or -RE**

= Right Angle

**-NA**

= Right Angle (using straight body for coplanar mating with SSW-RA series)

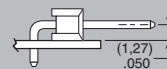

(1,27) .050

**-LL**

= Locking Lead



Two leads per strip crimped in opposite directions on or near centerline. See charts for available styles. N/A with single row 1 or 2 positions. Recommended hole size (1,02mm ± 0,03mm) .040" ± .001"

**-LC**

= Locking Clip (Styles -08 thru -13 & -22 only)

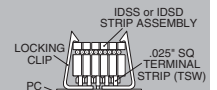

Requires 4 pin minimum (NA with -T, -Q, -RA or -RE)

**-LA**

= -RA Option with -LL Option

**-"XXX"**

= Polarized Position

**Straight Pin Versions**

(Specify "LEAD STYLE" from chart)

STYLE	A	B	C
* -05	(3,30) .130	(8,51) .335	(2,67) .105
* -06	(2,41) .095	(7,62) .300	(2,67) .105
* -07	(2,54) .100	(10,92) .430	
* -08	(5,08) .200	(13,46) .530	
-09	(10,16) .400	(18,54) .730	
-10	(12,70) .500	(21,08) .830	(5,84) .230
-11	(15,24) .600	(23,62) .930	
-12	(17,78) .700	(26,16) 1,030	
-13	(22,86) .900	(31,24) 1,230	
-14	(2,79) .110	(13,46) .530	(8,13) .320
* -15		(18,54) .730	(13,21) .520
* -16	(7,87) .310		(8,13) .320
* -17	(2,79) .110	(21,08) .830	(15,74) .620

STYLE	A	B	C
* -18		(23,62) .930	(18,29) .720
* -19	(2,79) .110	(26,16) 1,030	(20,83) .820
* -20		(31,24) 1,230	(25,91) 1,020
* -21		(36,32) 1,430	(30,99) 1,220
* -22	(7,62) .300	(16,00) .630	(5,84) .230
* -23	(2,92) .115	(11,30) .445	
* -24	(5,33) .210	(12,15) .480	(6,73) .265
* -25	(5,33) .210	(16,00) .630	(8,13) .320
▲ -26	(3,20) .126	(11,58) .456	
-27	(25,40) 1,000	(33,78) 1,330	(5,84) .230
-28	(20,32) .800	(28,70) 1,130	
-29	(23,11) .910	(33,78) 1,330	(8,13) .320
-30	(18,03) .710	(28,70) 1,130	
-41+	(0,89) .035	(9,27) .365	(5,84) .230
-42+	(1,27) .050	(11,94) .470	(8,13) .320

+ Style -41 & -42 available with HTSW only.

▲ Except: Style -26 (0,46) .018 DIA Tail

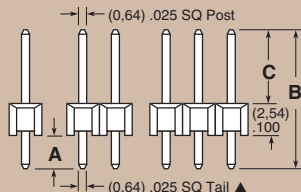

Specify -07 for best mate with IDXX Series IDC Cable

**Right Angle Versions**

(Specify "LEAD STYLE" from chart and select -RA or -RE from other options)

-RA LEAD STYLE	SINGLE (-S)		DOUBLE (-D)	TRIPLE (-T & -Q)	-RE LEAD STYLE	SINGLE A	C
	A	C	A	A			
-08	(2,29) .090		(2,29) .090	(2,29) .090	-09	(4,83) .190	
-09	(7,37) .290		(7,37) .290	(7,37) .290	-10	(7,37) .290	
-10	(9,91) .390	(5,84) .230	(9,91) .390	(9,91) .390	-11	(9,91) .390	(5,84) .230
-11	(12,45) .490		(12,45) .490	(12,45) .490	-12	(12,45) .490	
-12	(14,99) .590		(14,99) .590	(14,99) .590	-13	(17,53) .690	
-13	(20,07) .790		(20,07) .790	N/A	-16	(2,54) .100	(8,13) .320
* -16	(5,08) .200	(8,13) .320	(5,08) .200	(5,08) .200	-21	(22,61) .890	
-21	(25,15) .990	(5,84) .230	N/A	N/A	-22	(2,29) .090	(5,84) .230
* -22	(4,83) .190		(4,83) .190	(4,83) .190	-27	(20,07) .790	
* -25	(2,54) .100	(8,13) .320	(2,54) .100	(2,54) .100	-28	(17,53) .690	
-27	(22,61) .890	(5,84) .230	N/A	N/A	-29	(20,32) .800	
-28	(17,53) .690		(17,53) .690	N/A	-30	(15,24) .600	
-29	(20,32) .800	(8,13) .320	N/A	N/A			
-30	(15,24) .600		(15,24) .600				

\* Available with -LA (Locking Lead) Option

**ALSO AVAILABLE**

Elevated Right Angle option. Call Samtec.

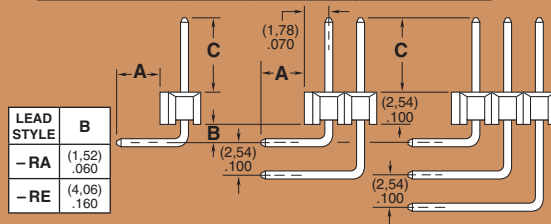

Due to technical progress, all designs, specifications and components are subject to change without notice.

WWW.SAMTEC.COM