

## Low power JFET quad operational amplifier

Datasheet – production data

### Features

- Very low power consumption: 200  $\mu$ A
- Wide common-mode (up to  $V_{CC}^+$ ) and differential voltage ranges
- Low input bias and offset currents
- Output short-circuit protection
- High input impedance JFET input stage
- Internal frequency compensation
- Latch up free operation
- High slew rate: 3.5 V/ $\mu$ s

### Description

The TL064, TL064A and TL064B are high-speed JFET input single operational amplifiers. Each of these JFET input operational amplifiers incorporates well matched, high-voltage JFET and bipolar transistors in a monolithic integrated circuit.

The devices feature high slew rates, low input bias and offset currents, and low offset voltage temperature coefficient.



**N**  
**DIP14**  
(Plastic package)

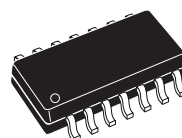

**D**  
**SO-14**  
(Plastic micropackage)

### Pin connections (Top view)

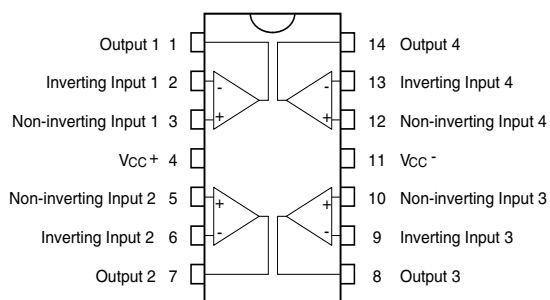

# Contents

<b>1</b>	<b>Schematic diagram</b> .....	<b>3</b>
<b>2</b>	<b>Absolute maximum ratings and operating conditions</b> .....	<b>4</b>
<b>3</b>	<b>Electrical characteristics</b> .....	<b>6</b>
<b>4</b>	<b>Parameter measurement information</b> .....	<b>11</b>
<b>5</b>	<b>Typical applications</b> .....	<b>11</b>
<b>6</b>	<b>ECOPACK®</b> .....	<b>12</b>
	6.1 DIP14 package mechanical data .....	13
	6.2 SO-14 package mechanical data .....	14
<b>7</b>	<b>Ordering information</b> .....	<b>15</b>
<b>8</b>	<b>Revision history</b> .....	<b>16</b>

# 1 Schematic diagram

Figure 1. Circuit schematics

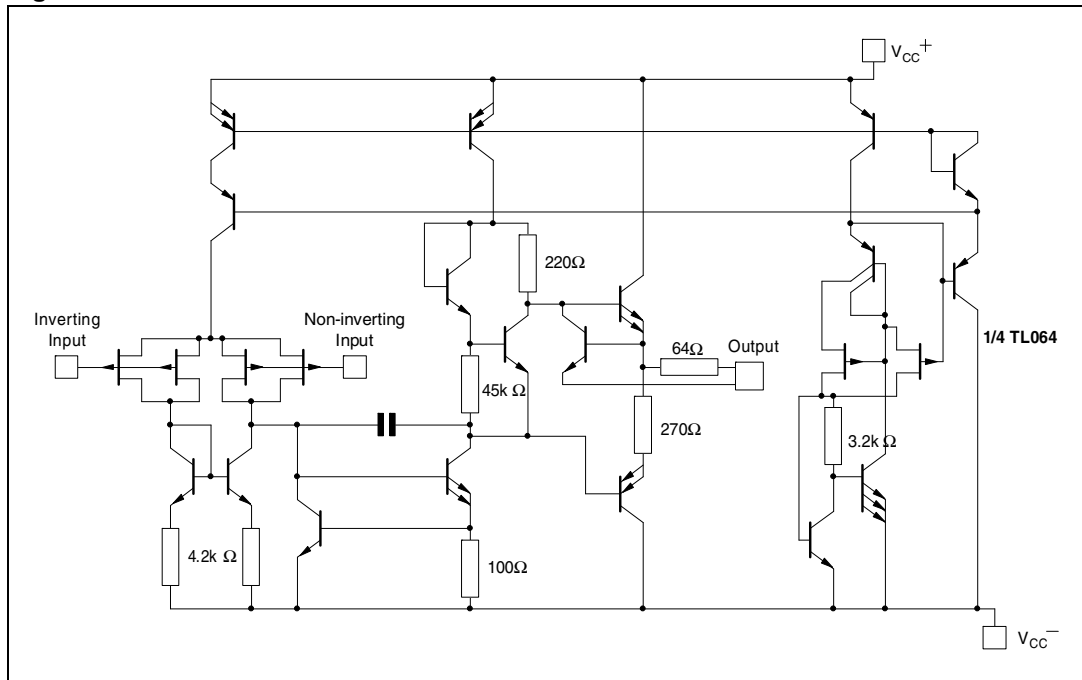

## 2 Absolute maximum ratings and operating conditions

**Table 1. Absolute maximum ratings**

Symbol	Parameter	Value	Unit
$V_{CC}$	Supply voltage <sup>(1)</sup>	±18	V
$V_i$	Input voltage <sup>(2)</sup>	±15	
$V_{id}$	Differential input voltage <sup>(3)</sup>	±30	
$P_{tot}$	Power dissipation	680	mW
$R_{thja}$	Thermal resistance junction to ambient <sup>(4)(5)</sup>		°C/W
	DIP14 SO-14	80 105	
$R_{thjc}$	Thermal resistance junction to case <sup>(4)(5)</sup>		
	DIP14 SO-14	33 31	
	Output short-circuit duration <sup>(6)</sup>	Infinite	
$T_{stg}$	Storage temperature range	-65 to +150	°C
ESD	HBM: human body model <sup>(7)</sup>	900	V
	MM: machine model <sup>(8)</sup>	200	
	CDM: charged device model <sup>(9)</sup>	1500	

1. All voltage values, except differential voltage, are with respect to the zero reference level (ground) of the supply voltages where the zero reference level is the midpoint between  $V_{CC}^+$  and  $V_{CC}^-$ .
2. The magnitude of the input voltage must never exceed the magnitude of the supply voltage or 15 volts, whichever is less.
3. Differential voltages are the non-inverting input terminal with respect to the inverting input terminal.
4. Short-circuits can cause excessive heating and destructive dissipation.
5.  $R_{th}$  are typical values.
6. The output may be shorted to ground or to either supply. Temperature and/or supply voltages must be limited to ensure that the dissipation rating is not exceeded.
7. Human body model: 100pF discharged through a 1.5kΩ resistor between two pins of the device, done for all couples of pin combinations with other pins floating.
8. Machine model: a 200pF cap is charged to the specified voltage, then discharged directly between two pins of the device with no external series resistor (internal resistor < 5Ω), done for all couples of pin combinations with other pins floating.
9. Charged device model: all pins plus package are charged together to the specified voltage and then discharged directly to the ground.

Table 2. Operating conditions

Product	Supply voltage range (V)	Operating free-air temperature range (°C)
TL064C TL064AC TL064BC	6 to 36	0 to +70
TL064I TL064AI TL064BI		-40 to +105
TL064M TL064AM TL064BM		-55 to +125

### 3 Electrical characteristics

Table 3.  $V_{CC} = \pm 15\text{ V}$ ,  $T_{amb} = +25^\circ\text{C}$  (unless otherwise specified)

Symbol	Parameter	TL064M			TL064I			TL064C			Unit
		Min.	Typ.	Max.	Min.	Typ.	Max.	Min.	Typ.	Max.	
$V_{io}$	Input offset voltage ( $R_S = 50\ \Omega$ ) $T_{min} \leq T_{amb} \leq T_{max}$		3	6 15		3	6 9		3	15 20	mV
$\Delta V_{io}/\Delta T$	Temperature coefficient of input offset voltage ( $R_S = 50\ \Omega$ )		10			10			10		$\mu\text{V}/^\circ\text{C}$
$I_{io}$	Input offset current <sup>(1)</sup> $T_{min} \leq T_{amb} \leq T_{max}$		5	100 20		5	100 10		5	200 5	pA nA
$I_{ib}$	Input bias current <sup>(1)</sup> $T_{min} \leq T_{amb} \leq T_{max}$		30	200 50		30	200 20		30	400 10	pA nA
$V_{icm}$	Input common mode voltage range $T_{min} \leq T_{amb} \leq T_{max}$	$\pm 11.5$	+15 -12		$\pm 11.5$	+15 -12		$\pm 11$	+15 -12		V
$V_{opp}$	Output voltage swing ( $R_L = 10\ \text{k}\Omega$ ) $T_{min} \leq T_{amb} \leq T_{max}$	20 20	27		20 20	27		20 20	27		
$A_{vd}$	Large signal voltage gain ( $R_L = 10\ \text{k}\Omega$ , $V_o = \pm 10\ \text{V}$ ) $T_{min} \leq T_{amb} \leq T_{max}$	4 4	6		4 4	6		3 3	6		V/mV
GBP	Gain bandwidth product ( $R_L = 10\ \text{k}\Omega$ , $C_L = 100\ \text{pF}$ )		1			1			1		MHz
$R_i$	Input resistance		$10^{12}$			$10^{12}$			$10^{12}$		$\Omega$
CMR	Common mode rejection ratio ( $R_S = 50\ \Omega$ )	80	86		80	86		70	76		dB
SVR	Supply voltage rejection ratio ( $R_S = 50\ \Omega$ )	80	95		80	95		70	95		
$I_{CC}$	Supply current, (per amplifier, no load, no signal)		200	250		200	250		200	250	$\mu\text{A}$
$V_{01}/V_{02}$	Channel separation ( $A_V = 100$ )		120			120			120		dB
$P_D$	Total power consumption (no load, no signal)		6	7.5		6	7.5		6	7.5	mW
SR	Slew rate ( $A_V = 1$ , $V_i = 10\ \text{V}$ , $R_L = 10\ \text{k}\Omega$ , $C_L = 100\ \text{pF}$ )	1.5	3.5		1.5	3.5		1.5	3.5		V/ $\mu\text{s}$
$t_r$	Rise time ( $A_V = 1$ , $V_i = 20\ \text{mV}$ , $R_L = 10\ \text{k}\Omega$ , $C_L = 100\ \text{pF}$ )		0.2			0.2			0.2		$\mu\text{s}$
$K_{ov}$	Overshoot factor ( $A_V = 1$ , $V_i = 20\ \text{mV}$ , $R_L = 10\ \text{k}\Omega$ , $C_L = 100\ \text{pF}$ , see <a href="#">Figure 2</a> )		10			10			10		%
$e_n$	Equivalent input noise voltage ( $R_S = 100\ \Omega$ , $f = 1\ \text{KHz}$ )		42			42			42		$\frac{\text{nV}}{\sqrt{\text{Hz}}}$

1. The input bias currents of a FET-input operational amplifier are normal junction reverse currents, which are temperature sensitive. Pulse techniques must be used that will maintain the junction temperature as close to the ambient temperature as possible.

Table 4.  $V_{CC} = \pm 15\text{ V}$ ,  $T_{amb} = +25^\circ\text{C}$  (unless otherwise specified)

Symbol	Parameter	TL064AM, AI, AC			TL064BM, BI, BC			Unit
		Min.	Typ.	Max.	Min.	Typ.	Max.	
$V_{io}$	Input offset voltage ( $R_S = 50\ \Omega$ ) $T_{min} \leq T_{amb} \leq T_{max}$		3	6 7.5		2	3 5	mV
$\Delta V_{io}/\Delta T$	Temperature coefficient of input offset voltage ( $R_S = 50\ \Omega$ )		10			10		$\mu\text{V}/^\circ\text{C}$
$I_{io}$	Input offset current <sup>(1)</sup> $T_{min} \leq T_{amb} \leq T_{max}$		5	100 3		5	100 3	pA nA
$I_{ib}$	Input bias current <sup>(1)</sup> $T_{min} \leq T_{amb} \leq T_{max}$		30	200 7		30	200 7	pA nA
$V_{icm}$	Input common mode voltage range $T_{min} \leq T_{amb} \leq T_{max}$	$\pm 11.5$	+15 -12		$\pm 11.5$	+15 -12		V
$V_{opp}$	Output voltage swing ( $R_L = 10\ \text{k}\Omega$ ) $T_{min} \leq T_{amb} \leq T_{max}$	20 20	27		20 20	27		
$A_{vd}$	Large signal voltage gain ( $R_L = 10\ \text{k}\Omega$ , $V_o = \pm 10\ \text{V}$ ) $T_{min} \leq T_{amb} \leq T_{max}$	4 4	6		4 4	6		V/mV
GBP	Gain bandwidth product ( $R_L = 10\ \text{k}\Omega$ , $C_L = 100\ \text{pF}$ )		1			1		MHz
$R_i$	Input resistance		$10^{12}$			$10^{12}$		$\Omega$
CMR	Common mode rejection ratio ( $R_S = 50\ \Omega$ )	80	86		80	86		dB
SVR	Supply voltage rejection ratio ( $R_S = 50\ \Omega$ )	80	95		80	95		dB
$I_{CC}$	Supply current (per amplifier, no load, no signal)		200	250		200	250	$\mu\text{A}$
$V_{01}/V_{02}$	Channel separation ( $A_V = 100$ )		120			120		dB
$P_D$	Total power consumption (each amplifier, no load, no signal)		6	7.5		6	7.5	mW
SR	Slew rate ( $A_V = 1$ , $V_i = 10\ \text{V}$ , $R_L = 10\ \text{k}\Omega$ , $C_L = 100\ \text{pF}$ )	1.5	3.5		1.5	3.5		V/ $\mu\text{s}$
$t_r$	Rise time ( $A_V = 1$ , $V_i = 20\ \text{mV}$ , $R_L = 10\ \text{k}\Omega$ , $C_L = 100\ \text{pF}$ )		0.2			0.2		$\mu\text{s}$
$K_{ov}$	Overshoot factor ( $A_V = 1$ , $V_i = 20\ \text{mV}$ , $R_L = 10\ \text{k}\Omega$ , $C_L = 100\ \text{pF}$ , see <a href="#">Figure 2</a> )		10			10		%
$e_n$	Equivalent input noise voltage ( $R_S = 100\ \Omega$ , $f = 1\ \text{kHz}$ )		42			42		$\frac{\text{nV}}{\sqrt{\text{Hz}}}$

1. The input bias currents of an FET-input operational amplifier are normal junction reverse currents, which are temperature sensitive. Pulse techniques must be used that will maintain the junction temperature as close to the ambient temperature as possible.

**Figure 2. Maximum peak-to-peak output voltage versus supply voltage**

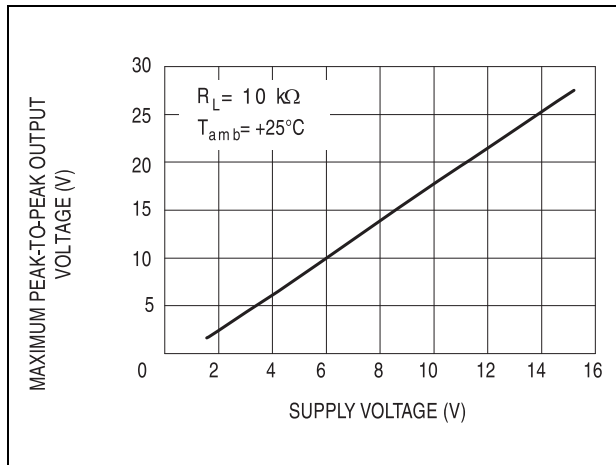

**Figure 3. Maximum peak-to-peak output voltage versus free air temp**

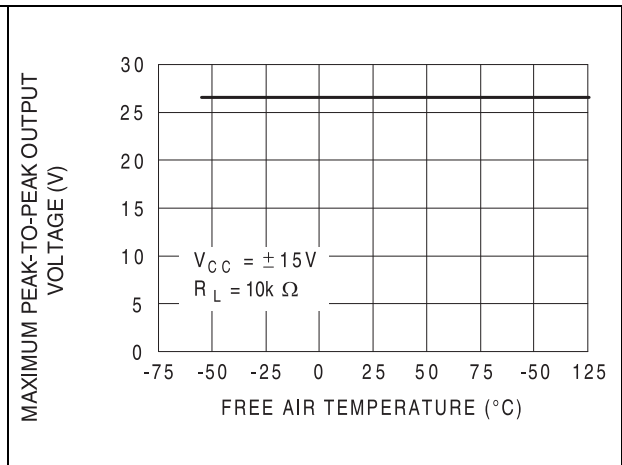

**Figure 4. Maximum peak-to-peak output voltage versus load resistance**

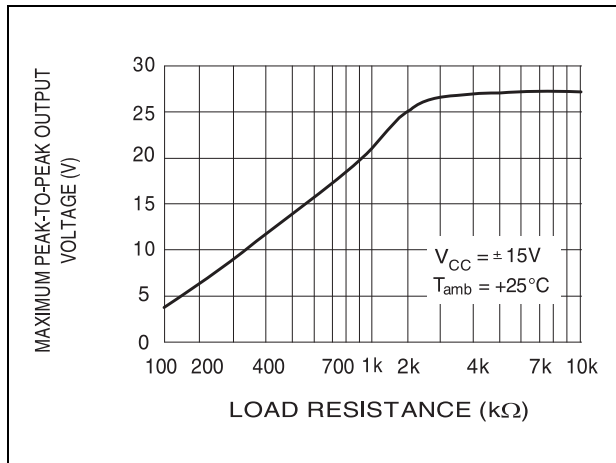

**Figure 5. Maximum peak-to-peak output voltage versus frequency**

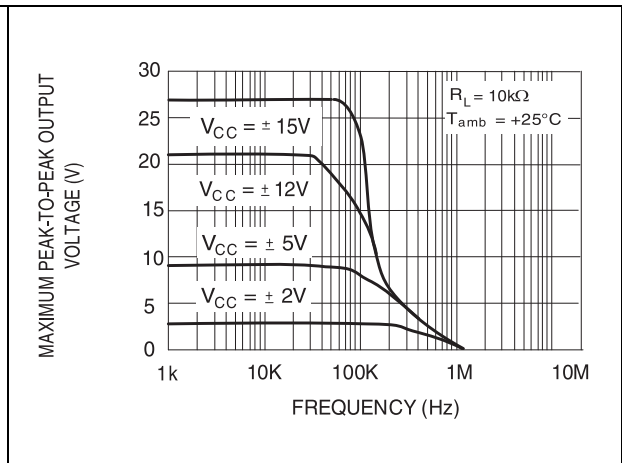

**Figure 6. Differential voltage amplification versus free air temperature**

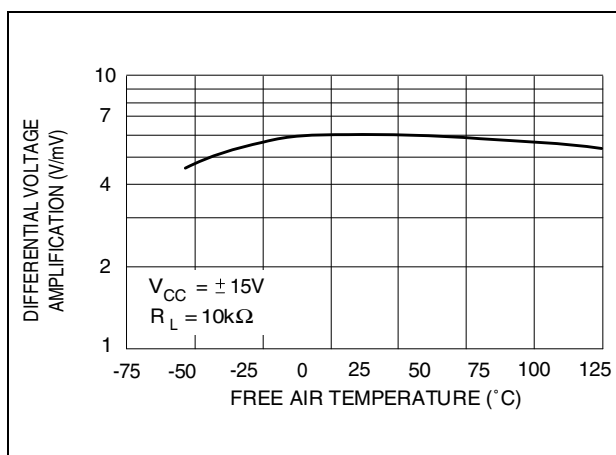

**Figure 7. Large signal differential voltage amplification and phase shift versus frequency**

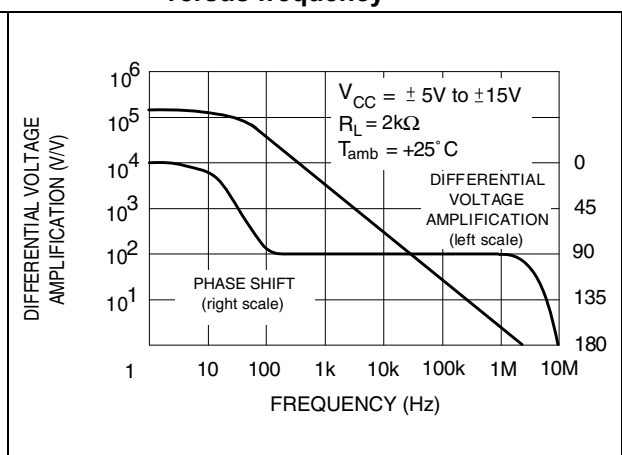



Figure 8. Supply current per amplifier versus supply voltage

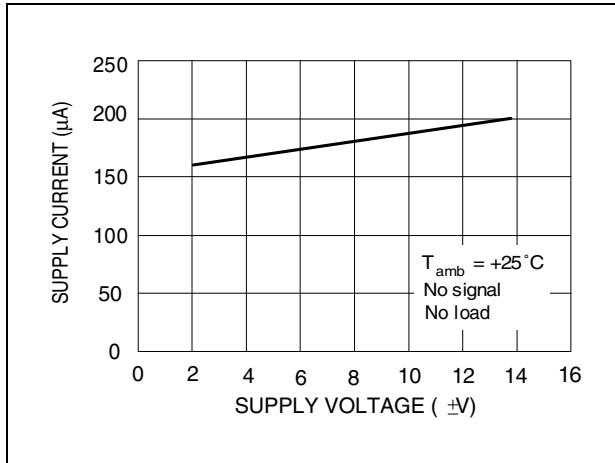

Figure 9. Supply current per amplifier versus free air temperature

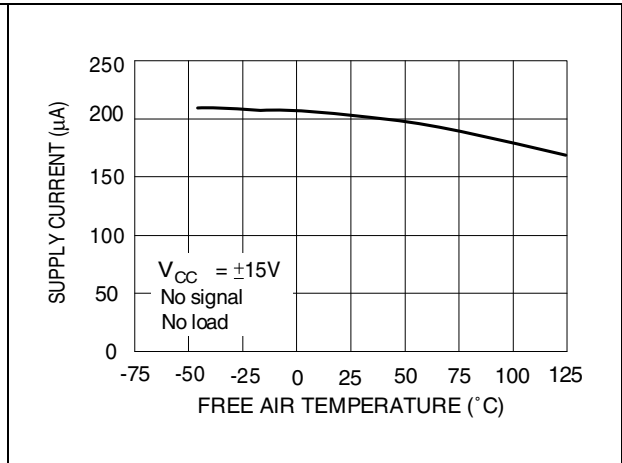

Figure 10. Total power dissipated versus free air temperature

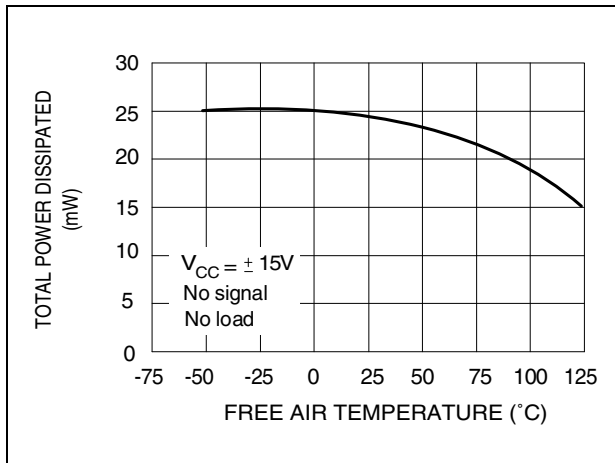

Figure 11. Common mode rejection ratio versus free air temperature

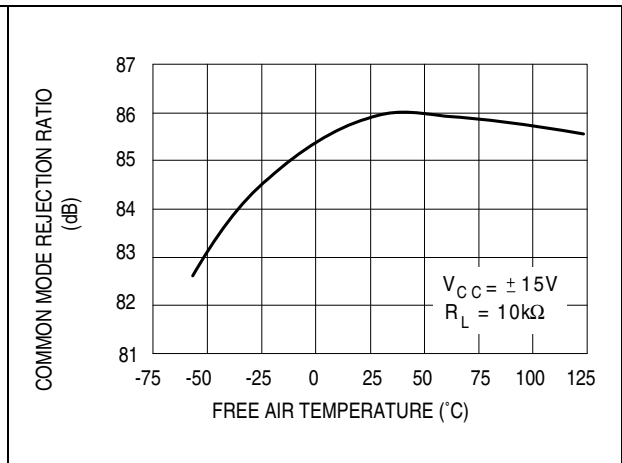

Figure 12. Normalized unity gain bandwidth, slew rate, and phase shift versus temperature

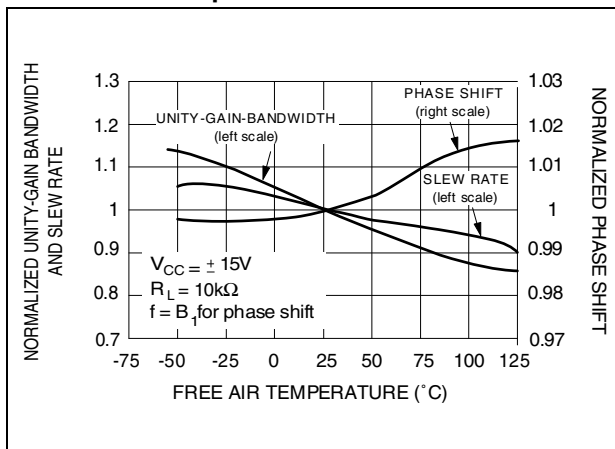

Figure 13. Input bias current versus free air temperature

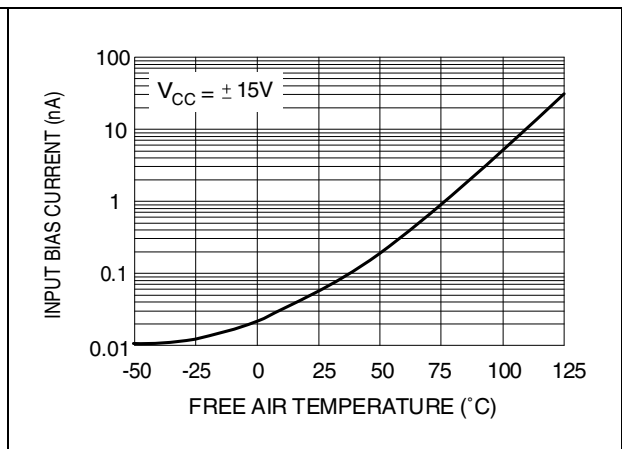

Figure 14. Voltage follower large signal pulse response      Figure 15. Output voltage versus elapsed time

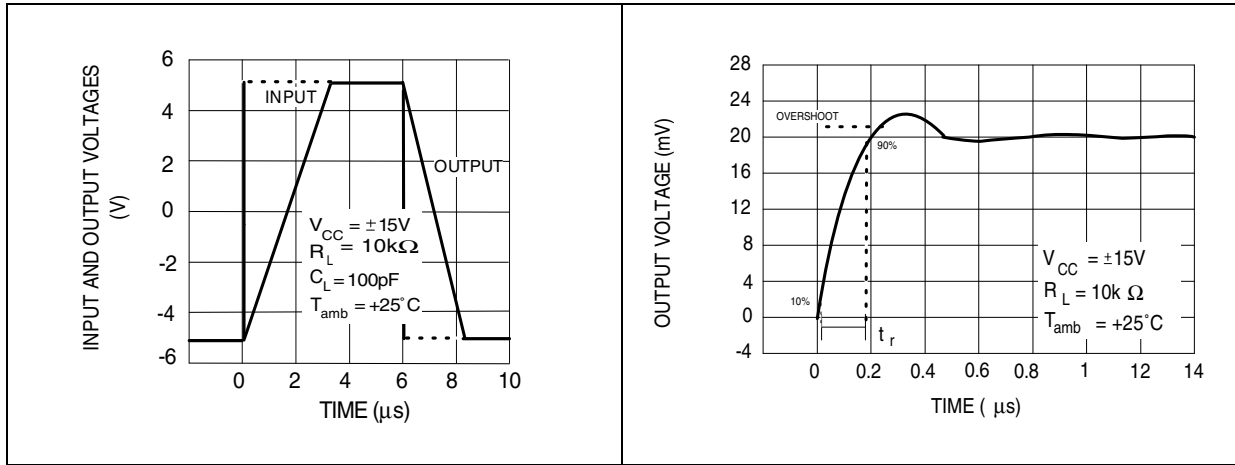
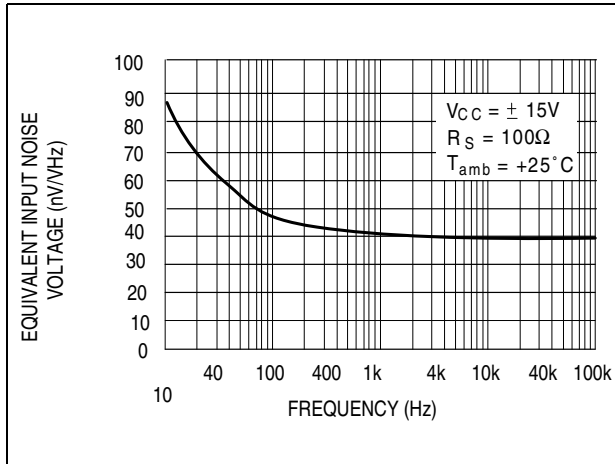

Figure 16. Equivalent input noise voltage versus frequency



## 4 Parameter measurement information

Figure 17. Voltage follower

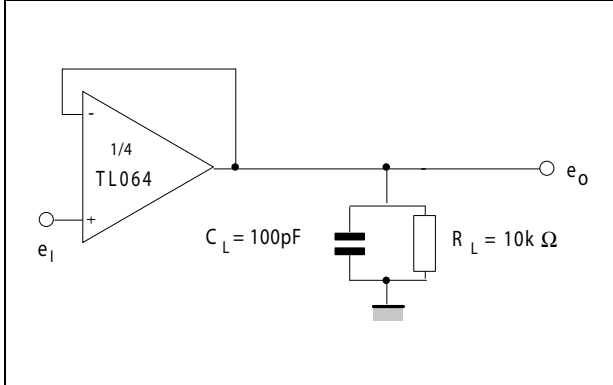
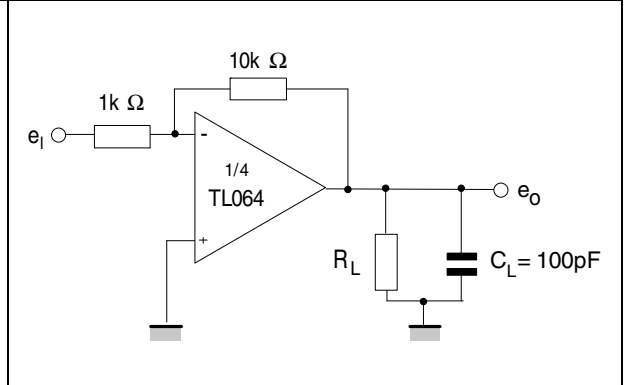
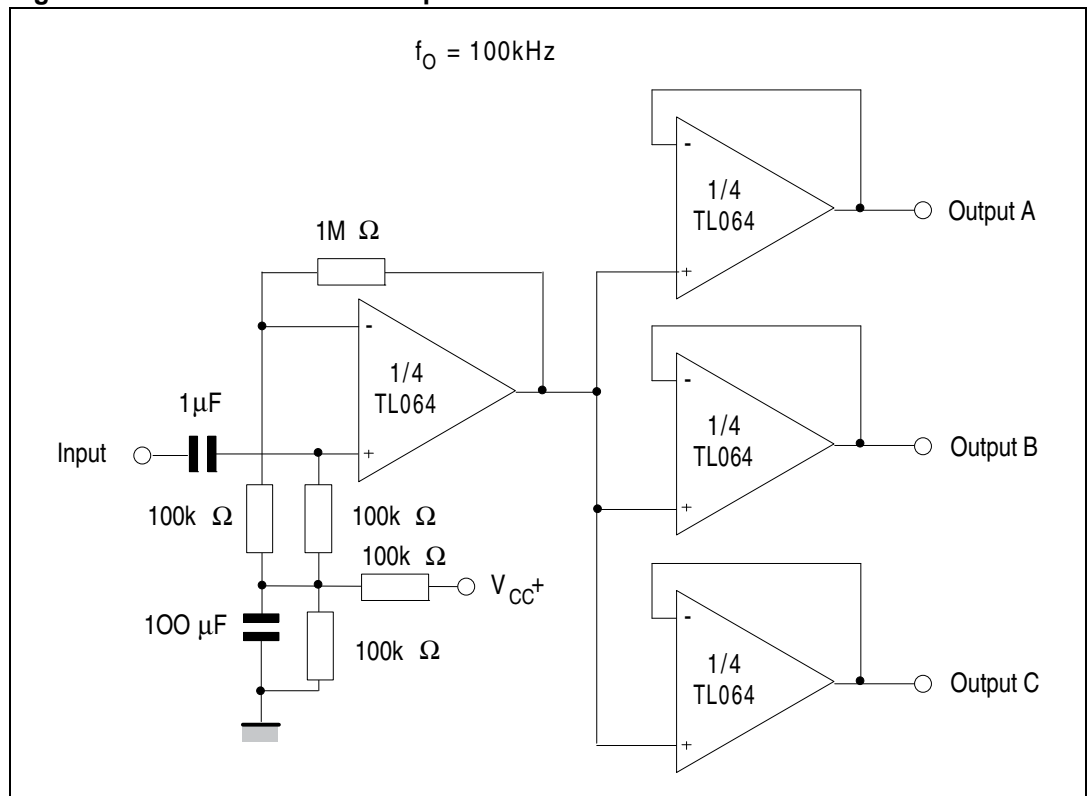

Figure 18. Gain-of-10 inverting amplifier



## 5 Typical applications

Figure 19. Audio distributor amplifier



## 6 ECOPACK®

In order to meet environmental requirements, ST offers these devices in different grades of ECOPACK® packages, depending on their level of environmental compliance. ECOPACK® specifications, grade definitions and product status are available at: [www.st.com](http://www.st.com). ECOPACK® is an ST trademark.

## 6.1 DIP14 package mechanical data

Figure 20. DIP14 package mechanical drawing

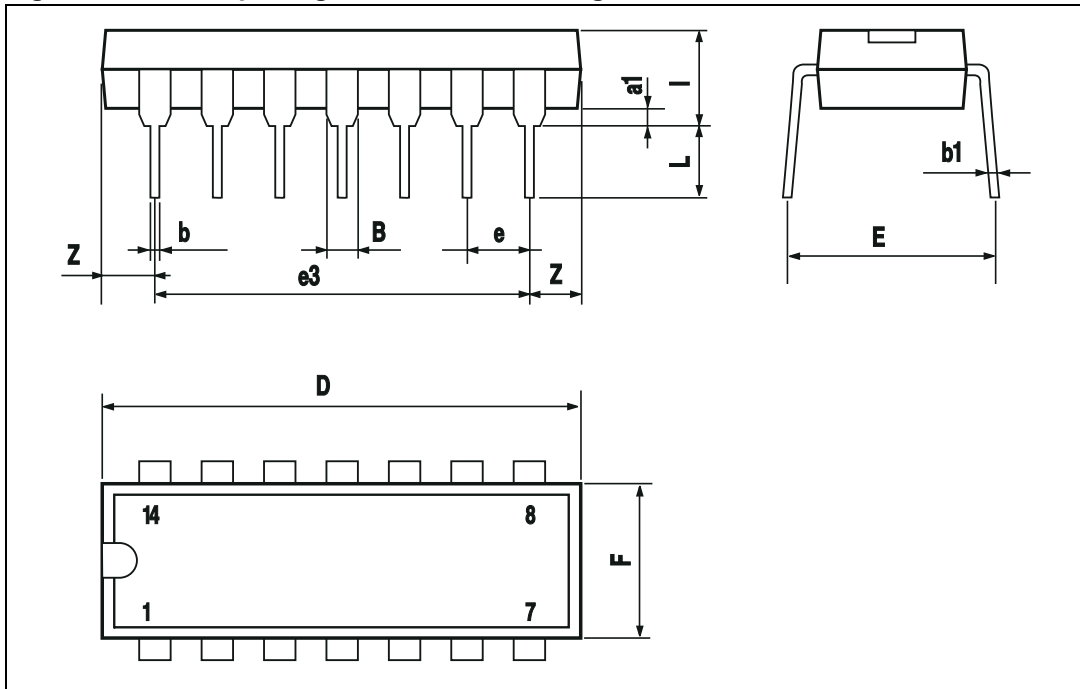

Table 5. DIP14 package mechanical data

Ref.	Dimensions					
	Millimeters			Inches		
	Min.	Typ.	Max.	Min.	Typ.	Max.
a1	0.51			0.020		
B	1.39		1.65	0.055		0.065
b		0.50			0.020	
b1		0.25			0.010	
D			20			0.787
E		8.5			0.335	
e		2.54			0.100	
e3		15.24			0.600	
F			7.1			0.280
l			5.1			0.201
L		3.3			0.130	
Z	1.27		2.54	0.050		0.100

## 6.2 SO-14 package mechanical data

Figure 21. SO-14 package mechanical drawing

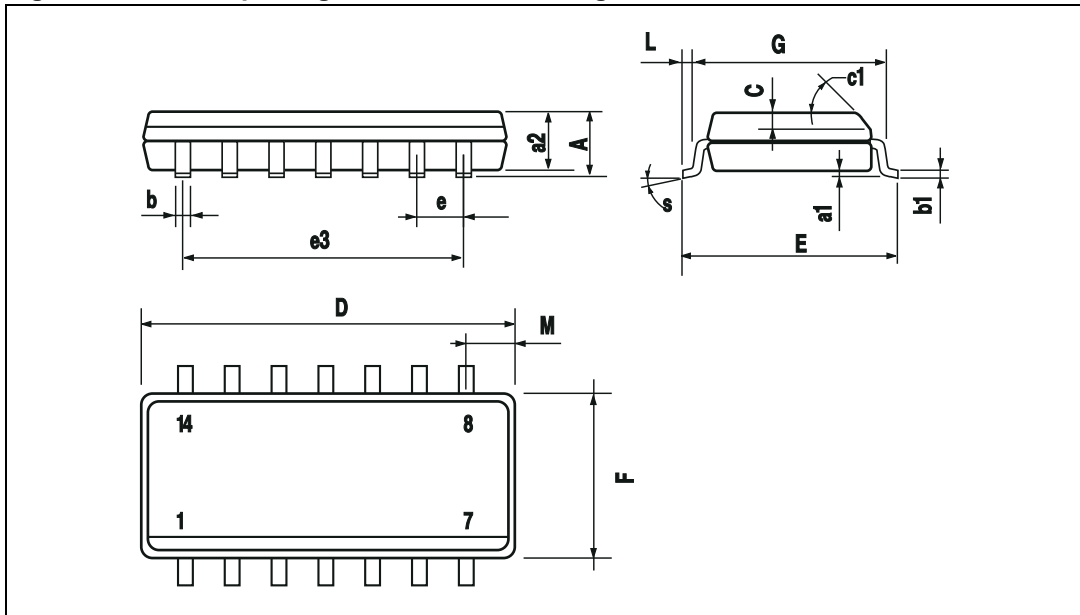

Table 6. SO-14 package mechanical data

Ref.	Dimensions					
	Millimeters			Inches		
	Min.	Typ.	Max.	Min.	Typ.	Max.
A			1.75			0.068
a1	0.10		0.20	0.003		0.007
a2			1.65			0.064
b	0.35		0.46	0.013		0.018
b1	0.19		0.25	0.007		0.010
C		0.50			0.019	
c1	45° (typ.)					
D	8.55		8.75	0.336		0.344
E	5.8		6.2	0.228		0.244
e		1.27			0.050	
e3		7.62			0.300	
F	3.8		4.0	0.149		0.157
G	4.6		5.3	0.181		0.208
L	0.50		1.27	0.019		0.050
M			0.68			0.026
S	8° (max.)					

## 7 Ordering information

Table 7. Order codes

Part number	Temperature range	Package	Packing	Marking
TL064MN	-55°C, +125°C	DIP14	Tube	TL064MN
TL064AMN				TL064AMN
TL064BMN				TL064BMN
TL064MD/DT		SO-14	Tube or tape & reel	064M
TL064AMD/DT				064AM
TL064BMD/DT				064BM
TL064IN	-40°C, +105°C	DIP14	Tube	TL064IN
TL064AIN				TL064AIN
TL064BIN				TL064BIN
TL064ID/DT		SO-14	Tube or tape & reel	064I
TL064AID/DT				064AI
TL064BID/DT				064BI
TL064CN	0°C, +70°C	DIP14	Tube	TL064CN
TL064ACN				TL064ACN
TL064BCN				TL064BCN
TL064CD/DT		SO-14	Tube or tape & reel	064C
TL064ACD/DT				064AC
TL064BCD/DT				064BC

## 8 Revision history

**Table 8. Document revision history**

Date	Revision	Changes
13-Nov-2001	1	Initial release.
25-Jul-2007	2	Added $R_{thja}$ , $R_{thjc}$ and ESD values in <a href="#">Table 1: Absolute maximum ratings</a> . Added <a href="#">Table 2: Operating conditions</a> . Expanded <a href="#">Table 7: Order codes</a> . Format update.
09-Jan-2013	3	Updated <a href="#">Table 1: Absolute maximum ratings</a> , <a href="#">Table 2: Operating conditions</a> , <a href="#">Table 3: <math>V_{CC} = \pm 15\text{ V}</math>, <math>T_{amb} = +25^\circ\text{C}</math> (unless otherwise specified)</a> , <a href="#">Table 4: <math>V_{CC} = \pm 15\text{ V}</math>, <math>T_{amb} = +25^\circ\text{C}</math> (unless otherwise specified)</a> , and <a href="#">Table 7: Order codes</a> . Replaced <a href="#">Figure 17: Voltage follower</a> .



**Please Read Carefully:**

Information in this document is provided solely in connection with ST products. STMicroelectronics NV and its subsidiaries ("ST") reserve the right to make changes, corrections, modifications or improvements, to this document, and the products and services described herein at any time, without notice.

All ST products are sold pursuant to ST's terms and conditions of sale.

Purchasers are solely responsible for the choice, selection and use of the ST products and services described herein, and ST assumes no liability whatsoever relating to the choice, selection or use of the ST products and services described herein.

No license, express or implied, by estoppel or otherwise, to any intellectual property rights is granted under this document. If any part of this document refers to any third party products or services it shall not be deemed a license grant by ST for the use of such third party products or services, or any intellectual property contained therein or considered as a warranty covering the use in any manner whatsoever of such third party products or services or any intellectual property contained therein.

**UNLESS OTHERWISE SET FORTH IN ST'S TERMS AND CONDITIONS OF SALE ST DISCLAIMS ANY EXPRESS OR IMPLIED WARRANTY WITH RESPECT TO THE USE AND/OR SALE OF ST PRODUCTS INCLUDING WITHOUT LIMITATION IMPLIED WARRANTIES OF MERCHANTABILITY, FITNESS FOR A PARTICULAR PURPOSE (AND THEIR EQUIVALENTS UNDER THE LAWS OF ANY JURISDICTION), OR INFRINGEMENT OF ANY PATENT, COPYRIGHT OR OTHER INTELLECTUAL PROPERTY RIGHT.**

**UNLESS EXPRESSLY APPROVED IN WRITING BY TWO AUTHORIZED ST REPRESENTATIVES, ST PRODUCTS ARE NOT RECOMMENDED, AUTHORIZED OR WARRANTED FOR USE IN MILITARY, AIR CRAFT, SPACE, LIFE SAVING, OR LIFE SUSTAINING APPLICATIONS, NOR IN PRODUCTS OR SYSTEMS WHERE FAILURE OR MALFUNCTION MAY RESULT IN PERSONAL INJURY, DEATH, OR SEVERE PROPERTY OR ENVIRONMENTAL DAMAGE. ST PRODUCTS WHICH ARE NOT SPECIFIED AS "AUTOMOTIVE GRADE" MAY ONLY BE USED IN AUTOMOTIVE APPLICATIONS AT USER'S OWN RISK.**

Resale of ST products with provisions different from the statements and/or technical features set forth in this document shall immediately void any warranty granted by ST for the ST product or service described herein and shall not create or extend in any manner whatsoever, any liability of ST.

ST and the ST logo are trademarks or registered trademarks of ST in various countries.

Information in this document supersedes and replaces all information previously supplied.

The ST logo is a registered trademark of STMicroelectronics. All other names are the property of their respective owners.

© 2013 STMicroelectronics - All rights reserved

STMicroelectronics group of companies

Australia - Belgium - Brazil - Canada - China - Czech Republic - Finland - France - Germany - Hong Kong - India - Israel - Italy - Japan - Malaysia - Malta - Morocco - Philippines - Singapore - Spain - Sweden - Switzerland - United Kingdom - United States of America

[www.st.com](http://www.st.com)