

NOTES:
 1. MATERIAL: LCP, 原色
 CONTACT PIN(10u") C2680-0.
 METAL SHELL C5191R-H.

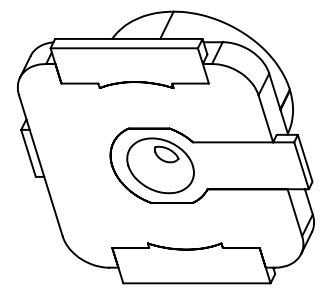
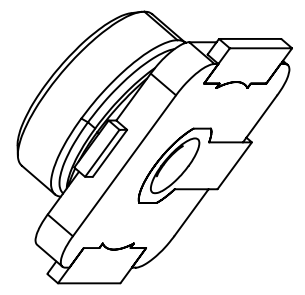
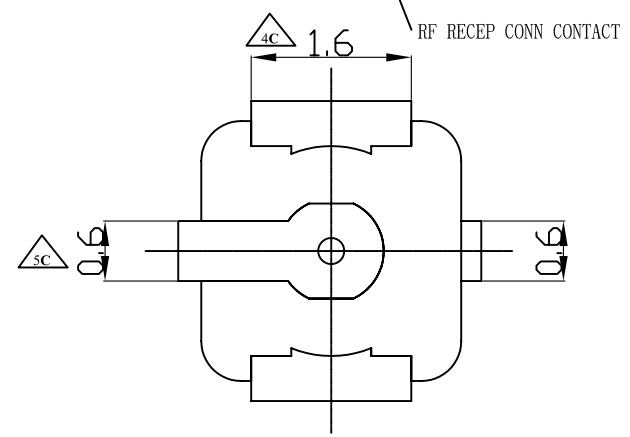
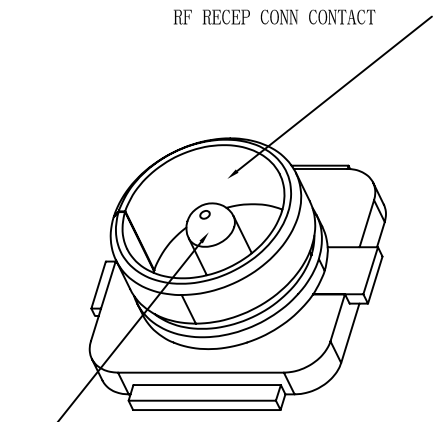
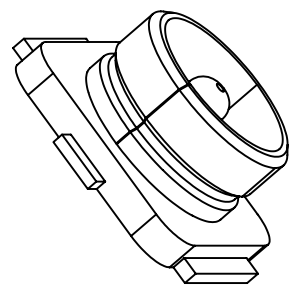
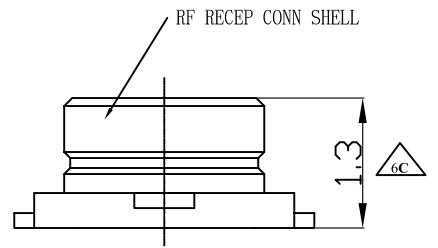
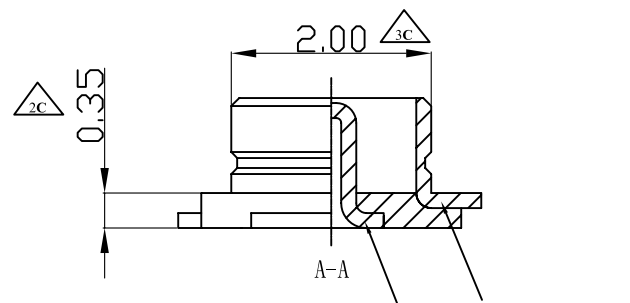

*標註△符號為品保檢驗尺寸

UFL-JV-50-LF
 LEADFREE
 RoHS Compliant

MORETHANALL
 CONNECTORS
 ASSEMBLIES

煜倫股份有限公司

PART NO. UFL-JV-50

DWG NO. UFL-JV-50

FILE NO.

UNIT / mm

SCALE 1:1

CHECKED BY CY

DRAWING BY

PROJECTION

TOLERANCES ARE

.X ± 0.2
 .XX ± 0.1
 .XXX ±
 AWG

DESCRIPTION:

U.FL P.C.B Mount

AREA

REVISIONS

HK

DATE