

Part Number: KCDC02-123

Green

Features

- 0.2 inch digit height.
- Low current operation.
- Excellent character appearance.
- Mechanically rugged.
- Package :300pcs / reel.
- Gray face, white segment.
- Moisture sensitivity level : level 2a.
- RoHS compliant.

Description

The Green source color devices are made with AlGaInP on GaAs substrate Light Emitting Diode.

Package Dimensions& Internal Circuit Diagram

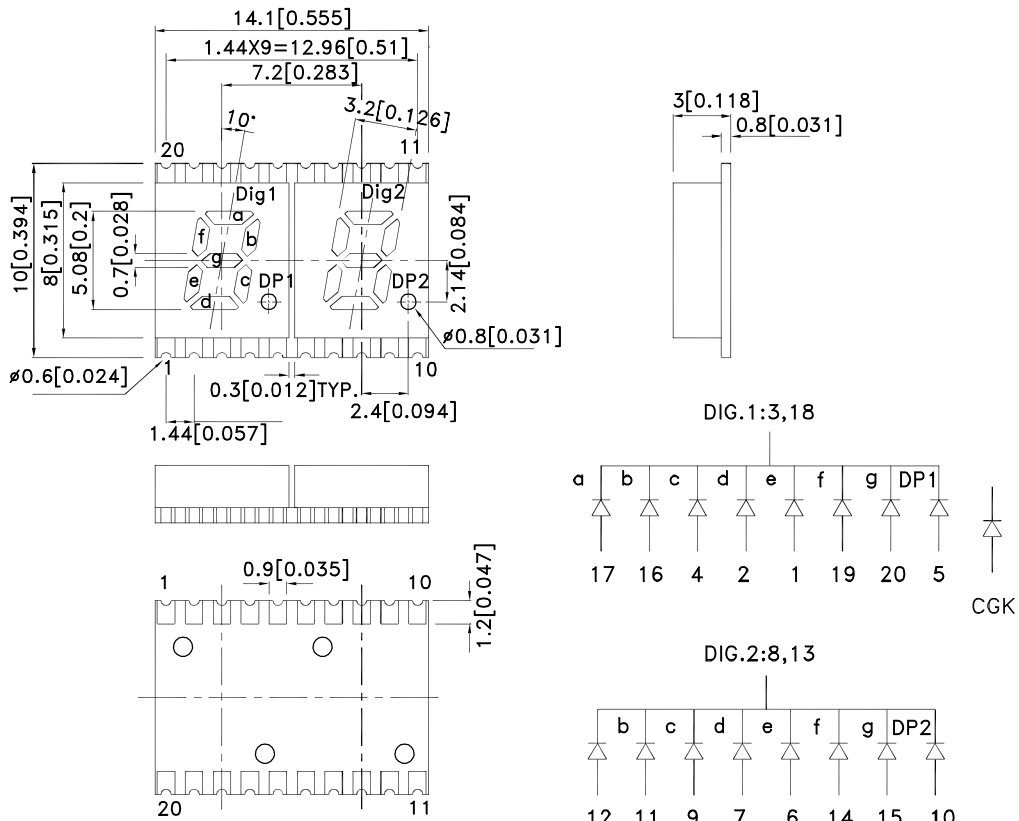

Notes:

1. All dimensions are in millimeters (inches), Tolerance is $\pm 0.25(0.01)$ unless otherwise noted.
2. The specifications, characteristics and technical data described in the datasheet are subject to change without prior notice.
3. The gap between the reflector and PCB shall not exceed 0.25mm.



Selection Guide

Part No.	Dice	Lens Type	Iv (ucd) [1] @ 10mA		Description
			Min.	Typ.	
KCDC02-123	Green (AlGaInP)	White Diffused	3600	12000	Common Cathode, Rt. Hand Decimal.
			*2200	*4300	

Note:

1. Luminous intensity/ luminous Flux: +/-15%.

* Luminous intensity value is traceable to the CIE127-2007 compliant national standards.

Electrical / Optical Characteristics at TA=25°C

Symbol	Parameter	Device	Typ.	Max.	Units	Test Conditions
λ_{peak}	Peak Wavelength	Green	574		nm	I _F =20mA
λ_D [1]	Dominant Wavelength	Green	570		nm	I _F =20mA
$\Delta\lambda_{1/2}$	Spectral Line Half-width	Green	20		nm	I _F =20mA
C	Capacitance	Green	15		pF	V _F =0V;f=1MHz
V _F [2]	Forward Voltage	Green	2.1	2.5	V	I _F =20mA
I _R	Reverse Current	Green		10	uA	V _R =5V

Notes:

1. Wavelength: +/-1nm.

2. Forward Voltage: +/-0.1V.

3. Wavelength value is traceable to the CIE127-2007 compliant national standards.

Absolute Maximum Ratings at TA=25°C

Parameter	Green	Units
Power dissipation	75	mW
DC Forward Current	30	mA
Peak Forward Current [1]	150	mA
Reverse Voltage	5	V
Operating / Storage Temperature	-40°C To +85°C	

Note:

1. 1/10 Duty Cycle, 0.1ms Pulse Width.

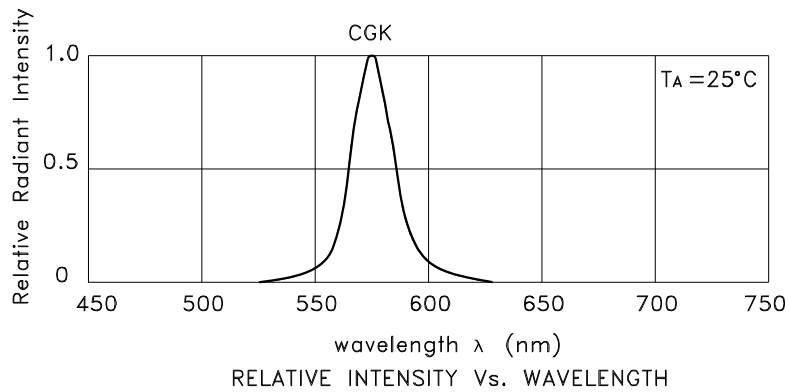

Green

KCDC02-123

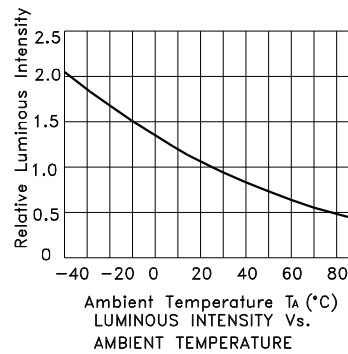
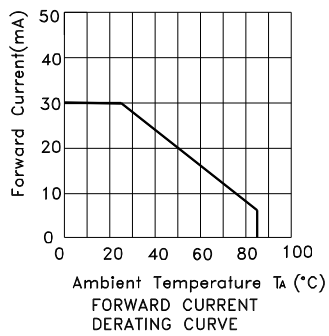
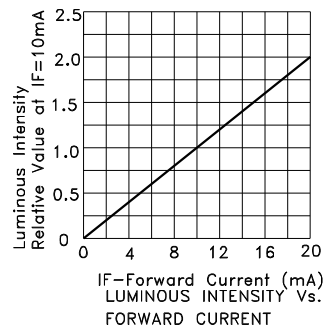
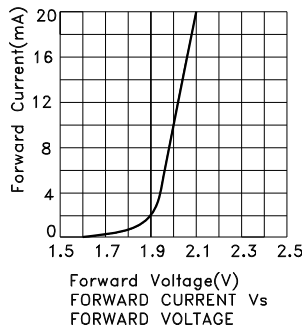

CIRCUIT DESIGN NOTES

1. Protective current-limiting resistors may be necessary to operate the Displays.
2. LEDs mounted in parallel should each be placed in series with its own current-limiting resistor.

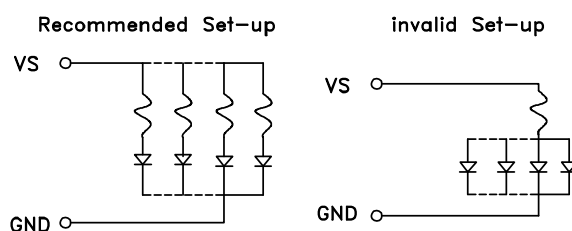

KCDC02-123

Reflow Soldering Profile For Lead-free SMT Process.

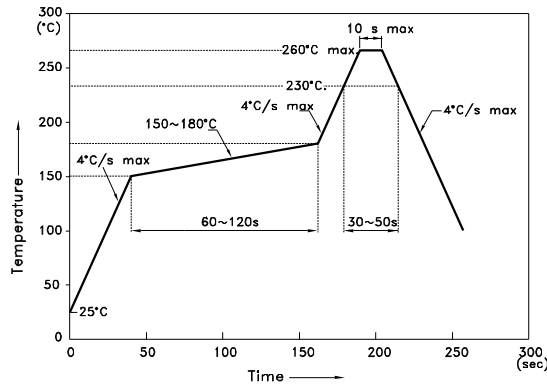

NOTES:

1. We recommend the reflow temperature 245°C(+/-5°C). The maximum soldering temperature should be limited to 260°C.
2. Don't cause stress to the epoxy resin while it is exposed to high temperature.
3. Number of reflow process shall be 2 times or less.

Recommended Soldering Pattern (Units : mm; Tolerance: ± 0.15)

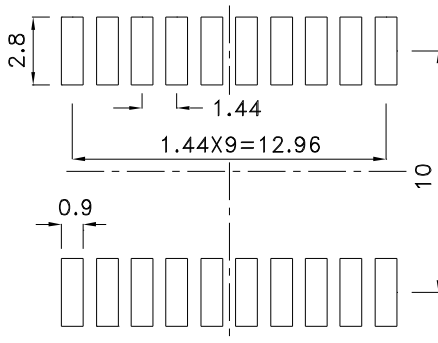

Reel Dimension

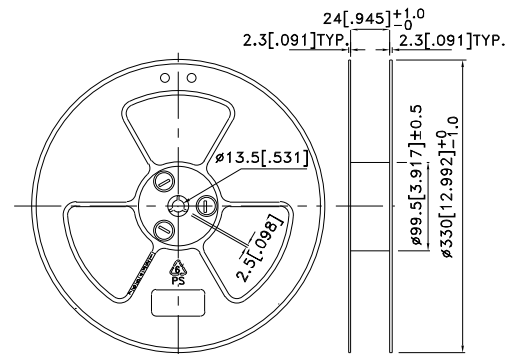

Tape Specifications (Units : mm)

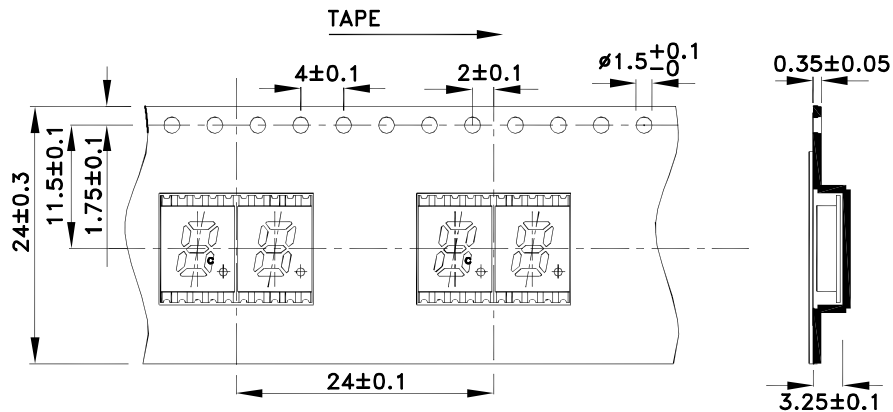

PACKING & LABEL SPECIFICATIONS

KCDC02-123

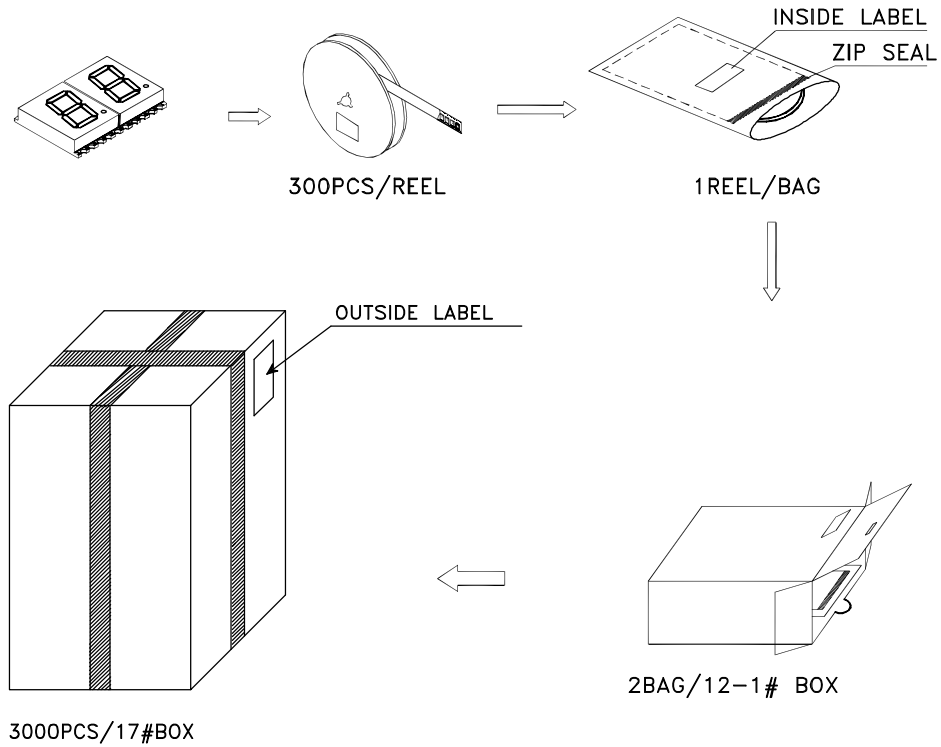

Inside Label On Tape

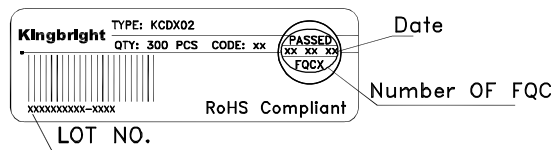

Outside Label On BAG

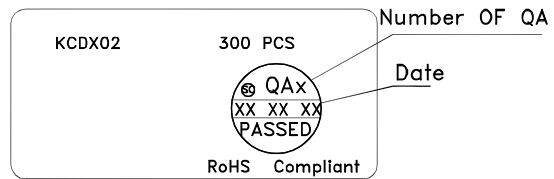

Outside Label On 17#Box

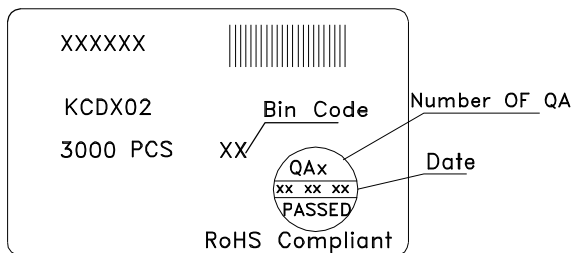

Outside Label On 12-1#Box

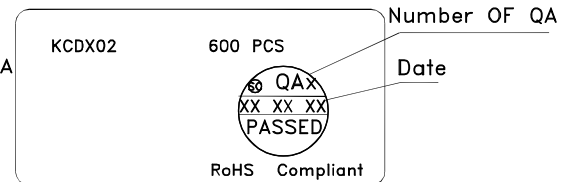

Detailed application notes are listed on our website.
http://www.kingbright.com/application_notes