

■ **Features**

- High Luminous LEDs
- 3mm Round Standard Directivity
- Superior Weather-resistance
- UV Resistant Epoxy
- Color Diffused Type

■ **Applications**

- Electronic Signs And Signals
- Small Area Illuminations
- Back Lighting
- Other Lighting

■ **Outline Dimension**

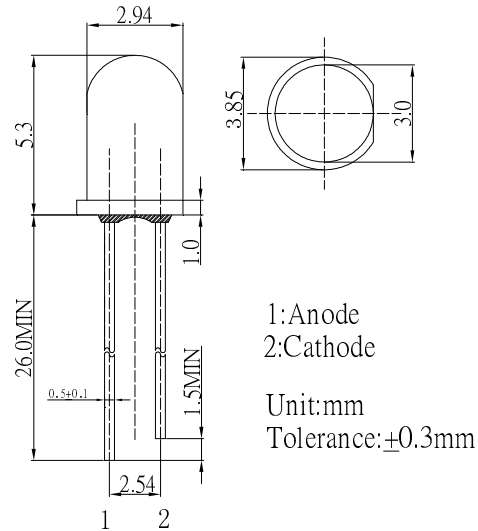

■ **Absolute Maximum Rating**

(Ta=25°C)

Item	Symbol	Value	Unit
DC Forward Current	I _F	30	mA
Pulse Forward Current*	I _{FP}	100	mA
Reverse Voltage	V _R	5	V
Power Dissipation	P _D	78	mW
Operating Temperature	Topr	-30 ~ +85	°C
Storage Temperature	Tstg	-40 ~ +100	°C
Lead Soldering Temperature	Tsol	260°C/5sec	-

■ **Directivity**

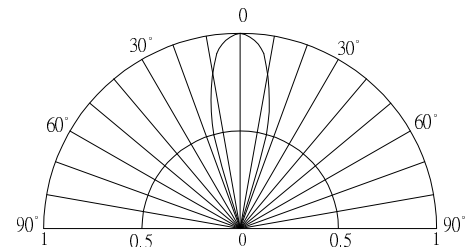

*Pulse width Max.10ms Duty ratio max 1/10

■ **Electrical -Optical Characteristics**

(Ta=25°C)

Item	Symbol	Condition	Min.	Typ.	Max.	Unit
DC Forward Voltage	V _F	I _F =20mA	1.8	2.1	2.6	V
DC Reverse Current	I _R	V _R =5V	-	-	10	μA
Domi. Wavelength*	λ _D	I _F =20mA	600	605	610	nm
Luminous Intensity*	I _v	I _F =20mA	30	45	-	mcd
50% Power Angle	2θ _{1/2}	I _F =20mA	-	30	-	deg

*1 Tolerance of dominant wavelength is ±1nm

*2 Tolerance of luminous intensity is ±15%