



# STW20NM50FD

## N-CHANNEL 500V - 0.22Ω - 20A TO-247 FDmesh™ Power MOSFET (with FAST DIODE)

TYPE	V <sub>DSS</sub>	R <sub>DS(on)</sub>	I <sub>D</sub>
STW20NM50FD	500V	<0.25Ω	20 A

- TYPICAL R<sub>DS(on)</sub> = 0.22Ω
- HIGH dv/dt AND AVALANCHE CAPABILITIES
- 100% AVALANCHE TESTED
- LOW INPUT CAPACITANCE AND GATE CHARGE
- LOW GATE INPUT RESISTANCE
- TIGHT PROCESS CONTROL AND HIGH MANUFACTURING YIELDS

### DESCRIPTION

The FDmesh™ associates all advantages of reduced on-resistance and fast switching with an intrinsic fast-recovery body diode. It is therefore strongly recommended for bridge topologies, in particular ZVS phase-shift converters.

### APPLICATIONS

- ZVS PHASE-SHIFT FULL BRIDGE CONVERTERS FOR SMPS AND WELDING EQUIPMENT

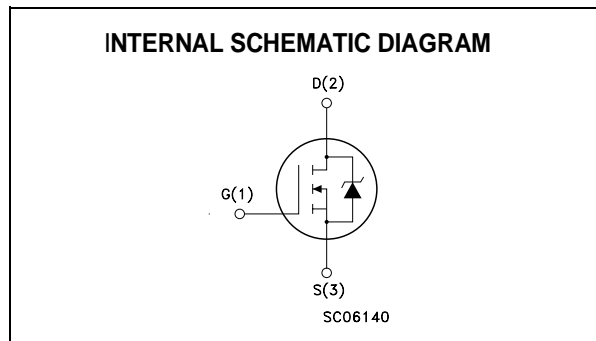
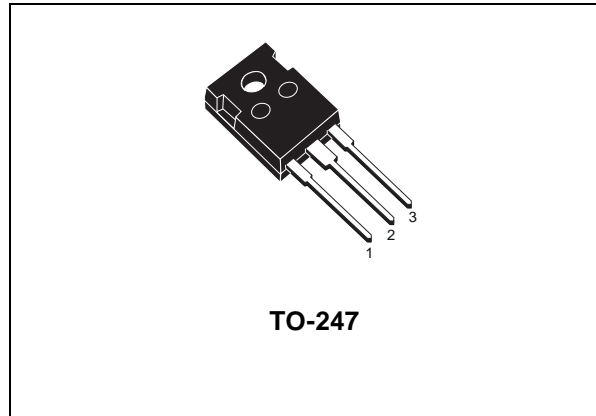

### ABSOLUTE MAXIMUM RATINGS

Symbol	Parameter	Value	Unit
V <sub>DS</sub>	Drain-source Voltage (V <sub>GS</sub> = 0)	500	V
V <sub>DGR</sub>	Drain-gate Voltage (R <sub>GS</sub> = 20 kΩ)	500	V
V <sub>GS</sub>	Gate- source Voltage	±30	V
I <sub>D</sub>	Drain Current (continuous) at T <sub>C</sub> = 25°C	20	A
I <sub>D</sub>	Drain Current (continuous) at T <sub>C</sub> = 100°C	14	A
I <sub>DM</sub> (●)	Drain Current (pulsed)	80	A
P <sub>TOT</sub>	Total Dissipation at T <sub>C</sub> = 25°C	214	W
	Derating Factor	1.42	W/°C
dv/dt(1)	Peak Diode Recovery voltage slope	20	V/ns
T <sub>stg</sub>	Storage Temperature	-65 to 150	°C
T <sub>j</sub>	Max. Operating Junction Temperature	150	°C

(●)Pulse width limited by safe operating area

(1)I<sub>SD</sub> ≤ 20A, di/dt ≤ 400A/μs, V<sub>DD</sub> ≤ V<sub>(BR)DSS</sub>, T<sub>j</sub> ≤ T<sub>JMAX</sub>.

(\*)Limited only by maximum temperature allowed

## STW20NM50FD

### THERMAL DATA

Rthj-case	Thermal Resistance Junction-case	Max	0.585	°C/W
Rthj-amb	Thermal Resistance Junction-ambient	Max	30	°C/W
T <sub>I</sub>	Maximum Lead Temperature For Soldering Purpose		300	°C

### AVALANCHE CHARACTERISTICS

Symbol	Parameter	Max Value	Unit
I <sub>AR</sub>	Avalanche Current, Repetitive or Not-Repetitive (pulse width limited by T <sub>j</sub> max)	10	A
E <sub>AS</sub>	Single Pulse Avalanche Energy (starting T <sub>j</sub> = 25 °C, I <sub>D</sub> = I <sub>AR</sub> , V <sub>DD</sub> = 35 V)	700	mJ

### ELECTRICAL CHARACTERISTICS (TCASE = 25 °C UNLESS OTHERWISE SPECIFIED)

OFF

Symbol	Parameter	Test Conditions	Min.	Typ.	Max.	Unit
V <sub>(BR)DSS</sub>	Drain-source Breakdown Voltage	I <sub>D</sub> = 250 μA, V <sub>GS</sub> = 0	500			V
I <sub>DSS</sub>	Zero Gate Voltage Drain Current (V <sub>GS</sub> = 0)	V <sub>DS</sub> = Max Rating V <sub>DS</sub> = Max Rating, T <sub>C</sub> = 125 °C			1 10	μA μA
I <sub>GSS</sub>	Gate-body Leakage Current (V <sub>DS</sub> = 0)	V <sub>GS</sub> = ±30V			±100	nA

ON (1)

Symbol	Parameter	Test Conditions	Min.	Typ.	Max.	Unit
V <sub>GS(th)</sub>	Gate Threshold Voltage	V <sub>DS</sub> = V <sub>GS</sub> , I <sub>D</sub> = 250μA	3	4	5	V
R <sub>DS(on)</sub>	Static Drain-source On Resistance	V <sub>GS</sub> = 10V, I <sub>D</sub> = 10A		0.22	0.25	Ω

### DYNAMIC

Symbol	Parameter	Test Conditions	Min.	Typ.	Max.	Unit
g <sub>fs</sub> (1)	Forward Transconductance	V <sub>DS</sub> > I <sub>D(on)</sub> × R <sub>DS(on)max</sub> , I <sub>D</sub> = 10A		9		S
C <sub>iss</sub>	Input Capacitance	V <sub>DS</sub> = 25V, f = 1 MHz, V <sub>GS</sub> = 0		1380		pF
C <sub>oss</sub>	Output Capacitance			290		pF
C <sub>rss</sub>	Reverse Transfer Capacitance			40		pF
C <sub>oss eq.</sub> (2)	Equivalent Output Capacitance	V <sub>GS</sub> = 0V, V <sub>DS</sub> = 0V to 400V		130		pF
R <sub>g</sub>	Gate Input Resistance	f=1 MHz Gate DC Bias=0 Test Signal Level=20mV Open Drain		2.8		Ω

1. Pulsed: Pulse duration = 300 μs, duty cycle 1.5 %.

2. C<sub>oss eq.</sub> is defined as a constant equivalent capacitance giving the same charging time as C<sub>oss</sub> when V<sub>DS</sub> increases from 0 to 80% V<sub>DSS</sub>.

**ELECTRICAL CHARACTERISTICS (CONTINUED)**  
SWITCHING ON

Symbol	Parameter	Test Conditions	Min.	Typ.	Max.	Unit
$t_{d(on)}$	Turn-on Delay Time	$V_{DD} = 250V, I_D = 10 A$ $R_G = 4.7\Omega, V_{GS} = 10V$		22		ns
$t_r$	Rise Time	(see test circuit, Figure 3)		20		ns
$Q_g$	Total Gate Charge	$V_{DD} = 400V, I_D = 20A,$ $V_{GS} = 10V$		38	53	nC
$Q_{gs}$	Gate-Source Charge			18		nC
$Q_{gd}$	Gate-Drain Charge			10		nC

SWITCHING OFF

Symbol	Parameter	Test Conditions	Min.	Typ.	Max.	Unit
$t_{r(Voff)}$	Off-voltage Rise Time	$V_{DD} = 400V, I_D = 20 A,$ $R_G = 4.7\Omega, V_{GS} = 10V$		6		ns
$t_f$	Fall Time	(see test circuit, Figure 5)		15		ns
$t_c$	Cross-over Time			30		ns

SOURCE DRAIN DIODE

Symbol	Parameter	Test Conditions	Min.	Typ.	Max.	Unit
$I_{SD}$	Source-drain Current				20	A
$I_{SDM(2)}$	Source-drain Current (pulsed)				80	A
$V_{SD(1)}$	Forward On Voltage	$I_{SD} = 20 A, V_{GS} = 0$			1.5	V
$t_{rr}$	Reverse Recovery Time	$I_{SD} = 20 A, di/dt = 100A/\mu s,$ $V_{DD} = 60V, T_j = 150^\circ C$		245		ns
$Q_{rr}$	Reverse Recovery Charge	(see test circuit, Figure 5)		2		$\mu C$
$I_{RRM}$	Reverse Recovery Current			16		A

Note: 1. Pulsed: Pulse duration = 300  $\mu s$ , duty cycle 1.5 %.  
2. Pulse width limited by safe operating area.

Safe Operating Area

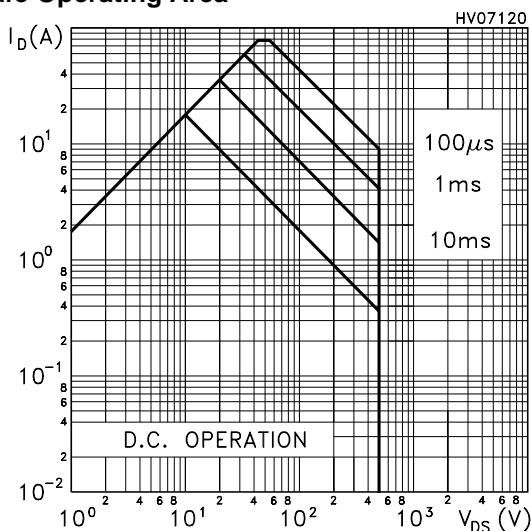

Thermal Impedance

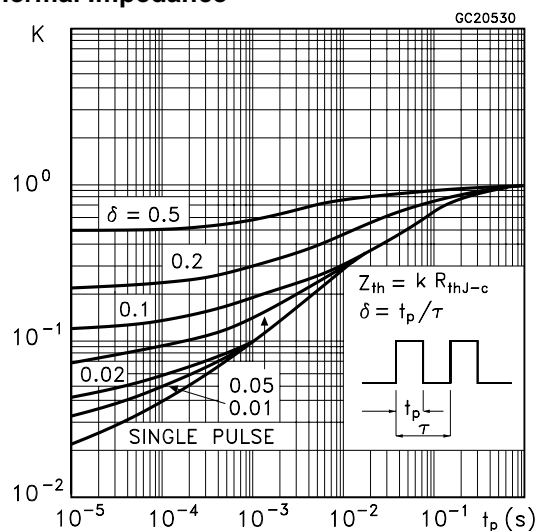

Output Characteristics

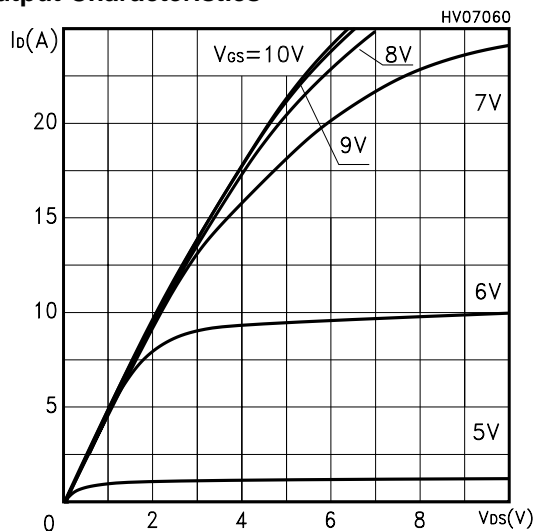

Transfer Characteristics

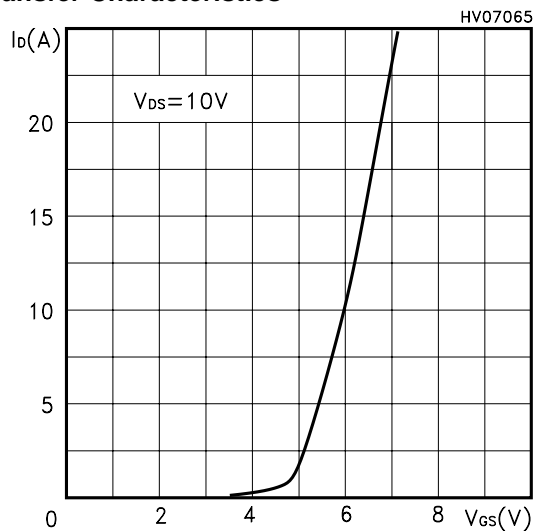

Transconductance

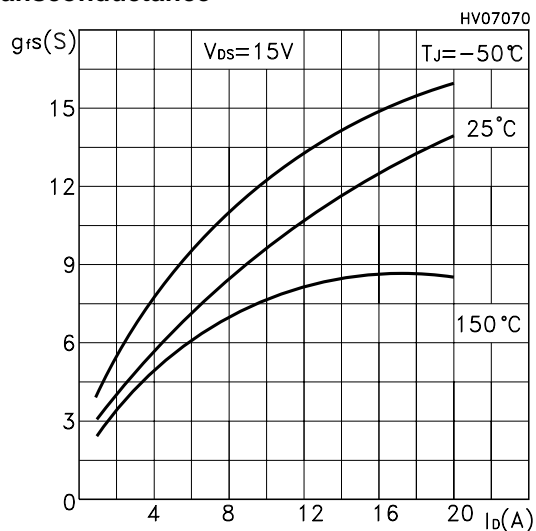

Static Drain-source On Resistance

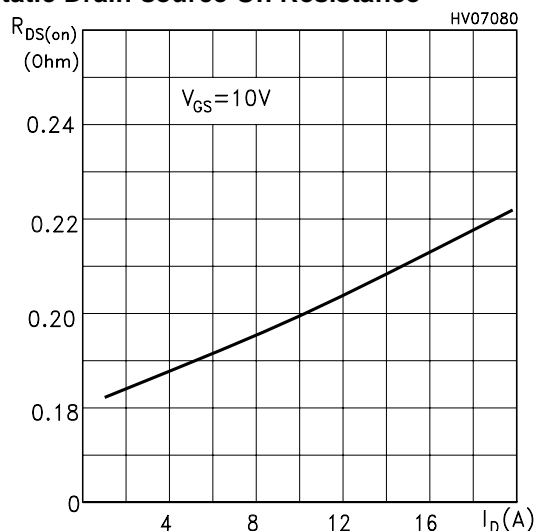

Gate Charge vs Gate-source Voltage

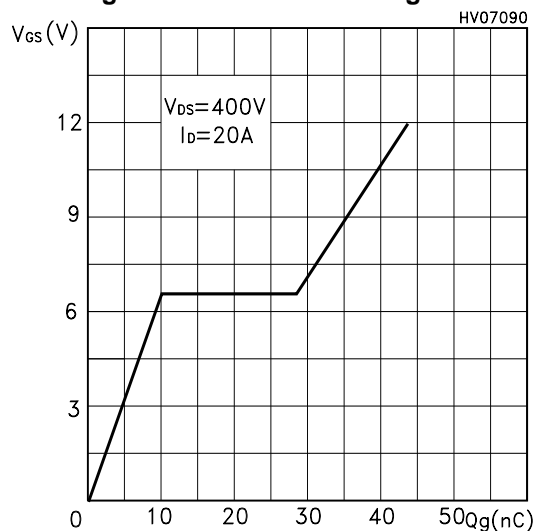

Capacitance Variations

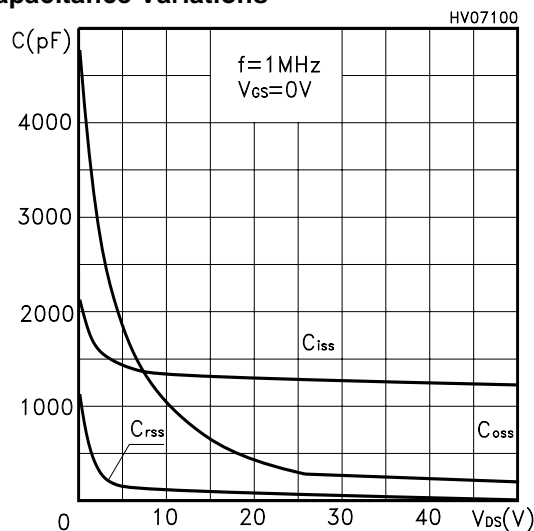

Normalized Gate Threshold Voltage vs Temp.

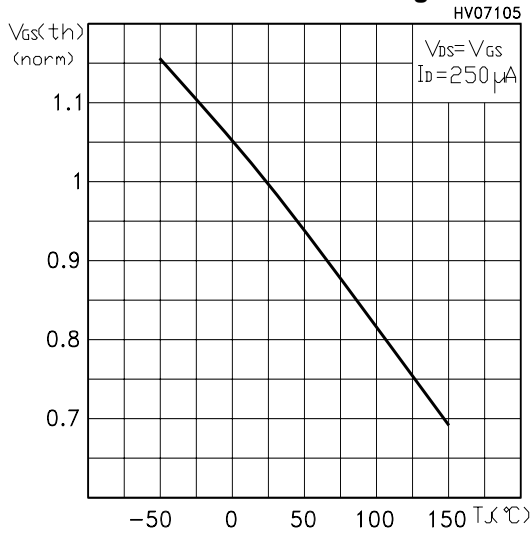

Normalized On Resistance vs Temperature

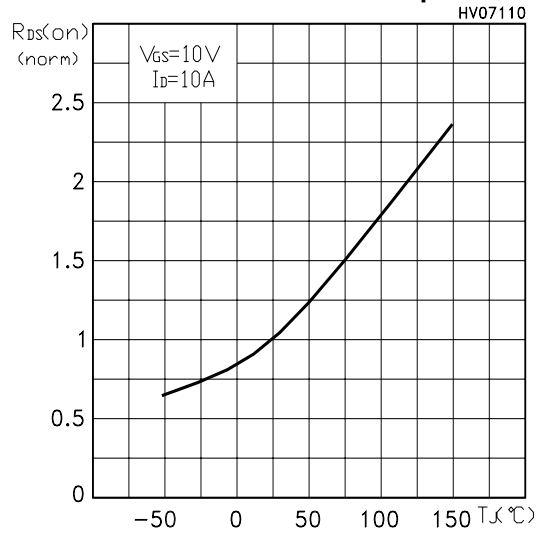

Source-drain Diode Forward Characteristics

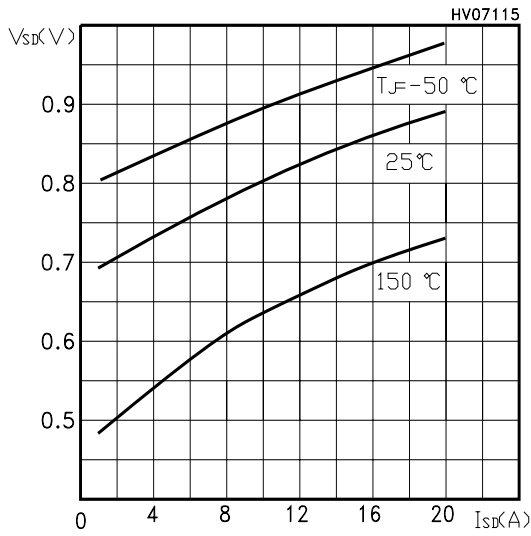

Fig. 1: Unclamped Inductive Load Test Circuit



Fig. 2: Unclamped Inductive Waveform



Fig. 3: Switching Times Test Circuits For Resistive Load



Fig. 4: Gate Charge test Circuit

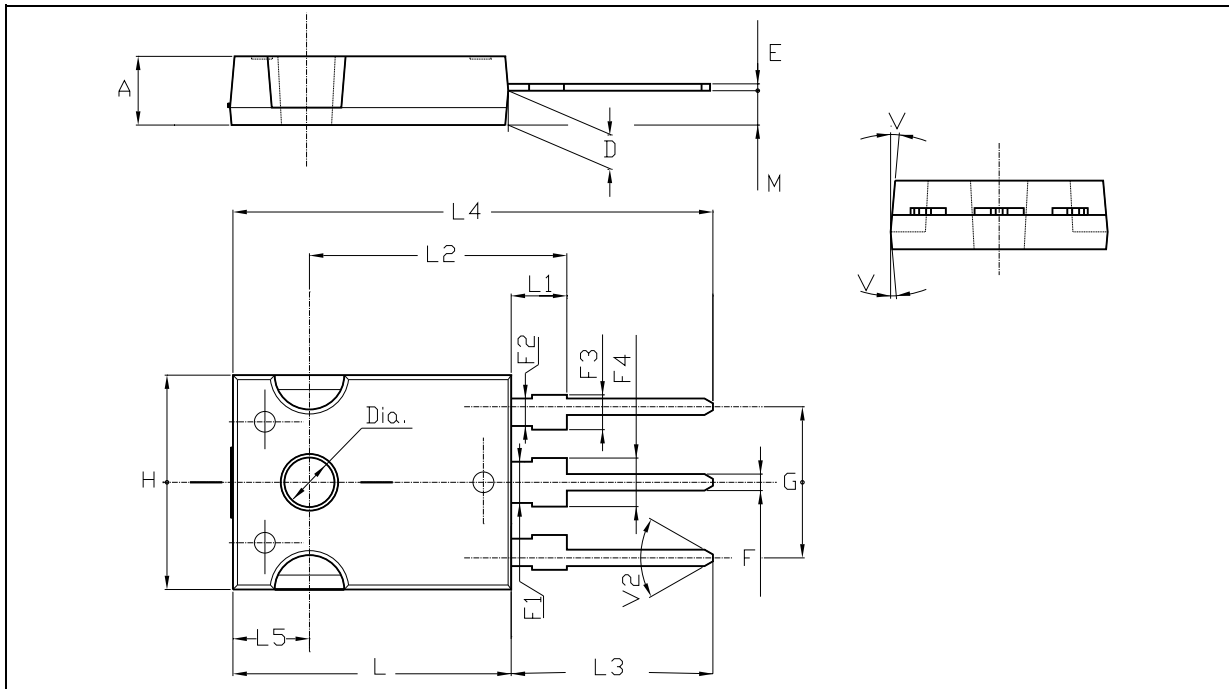

Fig. 5: Test Circuit For Inductive Load Switching And Diode Recovery Times



**TO-247 MECHANICAL DATA**

DIM.	mm.			inch		
	MIN.	TYP	MAX.	MIN.	TYP.	MAX.
A	4.85		5.15	0.19		0.20
D	2.20		2.60	0.08		0.10
E	0.40		0.80	0.015		0.03
F	1		1.40	0.04		0.05
F1		3			0.11	
F2		2			0.07	
F3	2		2.40	0.07		0.09
F4	3		3.40	0.11		0.13
G		10.90			0.43	
H	15.45		15.75	0.60		0.62
L	19.85		20.15	0.78		0.79
L1	3.70		4.30	0.14		0.17
L2		18.50			0.72	
L3	14.20		14.80	0.56		0.58
L4		34.60			1.36	
L5		5.50			0.21	
M	2		3	0.07		0.11
V		5°			5°	
V2		60°			60°	
Dia	3.55		3.65	0.14		0.143



Information furnished is believed to be accurate and reliable. However, STMicroelectronics assumes no responsibility for the consequences of use of such information nor for any infringement of patents or other rights of third parties which may result from its use. No license is granted by implication or otherwise under any patent or patent rights of STMicroelectronics. Specification mentioned in this publication are subject to change without notice. This publication supersedes and replaces all information previously supplied. STMicroelectronics products are not authorized for use as critical components in life support devices or systems without express written approval of STMicroelectronics.

The ST logo is a trademark of STMicroelectronics

© 2000 STMicroelectronics – Printed in Italy – All Rights Reserved

STMicroelectronics GROUP OF COMPANIES

Australia - Brazil - China - Finland - France - Germany - Hong Kong - India - Italy - Japan - Malaysia - Malta - Morocco -  
Singapore - Spain - Sweden - Switzerland - United Kingdom - U.S.A.

<http://www.st.com>