

HLMP-Pxxx Series, HLMP-Qxxx Series HLMP-6xxx Series, HLMP-70xx Series Subminiature LED Lamps



Data Sheet

Description

Flat Top Package

The HLMP-Pxxx Series flat top lamps use an untinted, non-diffused, truncated lens to provide a wide radiation pattern that is necessary for use in backlighting applications. The flat top lamps are also ideal for use as emitters in light pipe applications.

Dome Packages

The HLMP-6xxx Series dome lamps for use as indicators use a tinted, diffused lens to provide a wide viewing angle with a high on-off contrast ratio. High brightness lamps use an untinted, nondiffused lens to provide a high luminous intensity within a narrow radiation pattern.

Resistor Lamps

The HLMP-6xxx Series 5 volt subminiature lamps with built in current limiting resistors are for use in applications where space is at a premium.

Lead Configurations

All of these devices are made by encapsulating LED chips on axial lead frames to form molded epoxy subminiature lamp packages. A variety of package configuration options is available. These include special surface mount lead configurations, gull wing, yoke lead or Z-bend. Right angle lead bends at 2.54 mm (0.100 inch) and 5.08 mm (0.200 inch) center spacing are available for through hole mounting. For more information refer to Standard SMT and Through Hole Lead Bend Options for Subminiature LED Lamps data sheet.

Features

- Subminiature flat top package
 - ideal for backlighting and light piping applications
- Subminiature dome package
 - diffused dome for wide viewing angle
 - nondiffused dome for high brightness
- TTL and LSTTL compatible 5 volt resistor lamps
- Available in six colors
- Ideal for space limited applications
- Axial leads
- Available with lead configurations for surface mount and through hole PC board mounting

Device Selection Guide

Part Number: HLMP-xxxx

| Standard Red | DH AS AlGaAs Red | High Efficiency Red | Orange | Yellow | High Perf. Green | Emerald Green | Device Description ^[1] | Device Outline Drawing |
|--------------|------------------|---------------------|--------|--------|------------------|---------------|--|------------------------|
| P005 | P105 | P205 | P405 | P305 | P505 | P605 | Untinted, Nondiffused, Flat Top | A |
| | P102 | P202 | P402 | P302 | P502 | | Untinted, Diffused, Flat Top | A |
| 6000 | Q100 | 6300 | Q400 | 6400 | 6500 | Q600 | Tinted, Diffused | B |
| | Q105 | 6305 | Q405 | 6405 | 6505 | Q605 | Untinted, Nondiffused, High Brightness | B |
| | Q150 | 7000 | | 7019 | 7040 | | Tinted, Diffused, Low Current | B |
| | Q155 | | | | | | Nondiffused, Low Current | B |
| | | 6600 | | 6700 | 6800 | | Tinted, Diffused, Resistor, 5 V, 10 mA | B |
| | | 6620 | | 6720 | 6820 | | Diffused, Resistor, 5 V, 4 mA | B |

Ordering Information

HLMX-XXXX-X X X X X

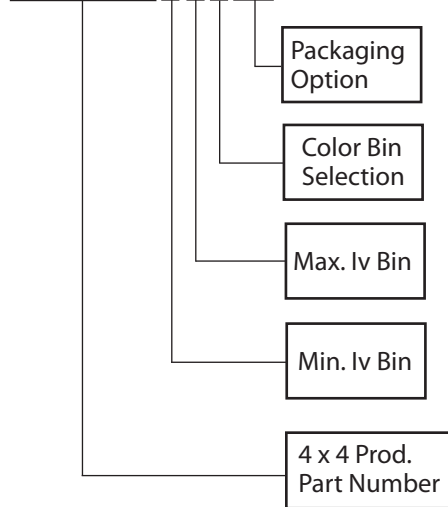

**Package Dimensions
(A) Flat Top Lamps**

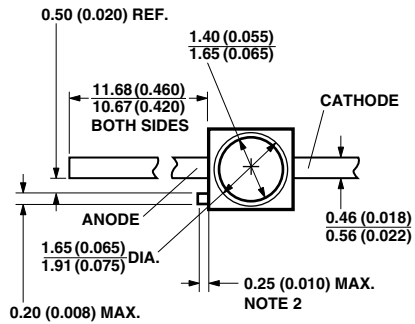

(B) Diffused and Nondiffused

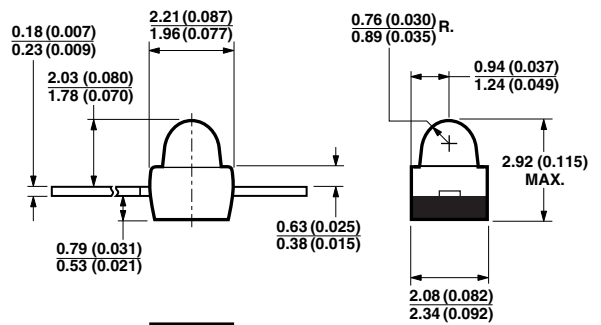
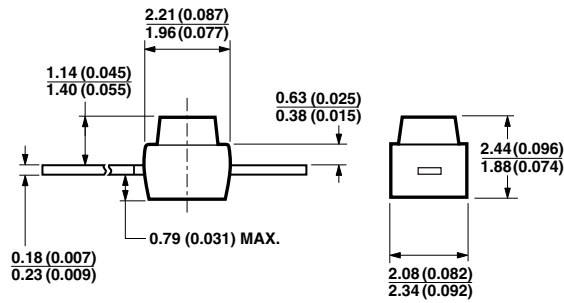
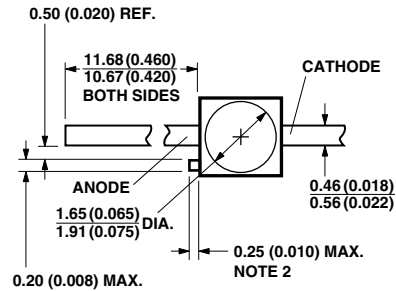

- NOTES:**
1. ALL DIMENSIONS ARE IN MILLIMETRES (INCHES).
 2. PROTRUDING SUPPORT TAB IS CONNECTED TO CATHODE LEAD.
 3. LEAD POLARITY FOR AlGaAs LAMPS IS OPPOSITE TO THE LEAD POLARITY OF SUBMINIATURE LAMPS USING OTHER TECHNOLOGIES.

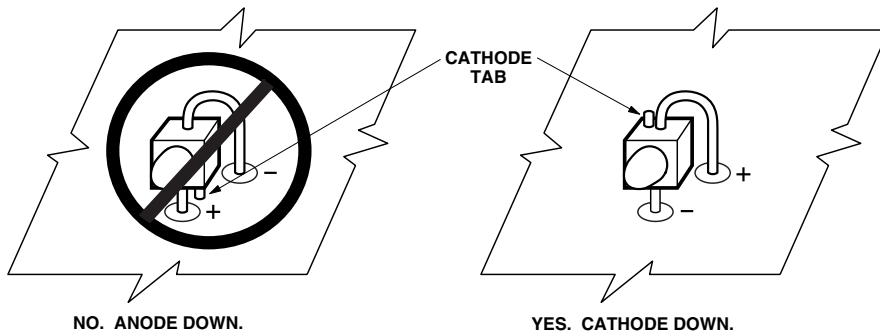

Figure 1. Proper right angle mounting to a PC board to prevent protruding cathode tab from shorting to anode connection.

Absolute Maximum Ratings at $T_A = 25^\circ\text{C}$

| Parameter | Standard Red | DH AS AlGaAs Red | High Eff. Red | Orange | Yellow | High Perf. Green | Emerald Green | Units |
|---|--------------|------------------|---------------|-------------------------------------|--------|------------------|---------------|------------------|
| DC Forward Current ^[1] | 50 | 30 | 30 | 30 | 20 | 30 | 30 | mA |
| Peak Forward Current ^[2] | 1000 | 300 | 90 | 90 | 60 | 90 | 90 | mA |
| DC Forward Voltage (Resistor Lamps Only) | | | 6 | | 6 | 6 | 6 | V |
| Reverse Voltage ($I_R = 100 \mu\text{A}$) | 5 | 5 | 5 | 5 | 5 | 5 | 5 | V |
| Transient Forward Current ^[3] (10 μs Pulse) | 2000 | 500 | 500 | 500 | 500 | 500 | 500 | mA |
| Operating Temperature Range: | | | | | | | | |
| Non-Resistor Lamps | -55 to +100 | -40 to +100 | | 55 to +100 | | -40 to +100 | -20 to +100 | $^\circ\text{C}$ |
| Resistor Lamps | | | | -40 to +85 | | | -20 to +85 | |
| Storage Temperature Range | | | | -55 to +100 | | | | $^\circ\text{C}$ |
| For Thru Hole Devices Wave Soldering Temperature [1.6 mm (0.063 in.) from body] | | | | 260 $^\circ\text{C}$ for 5 seconds | | | | |
| For Surface Mount Devices: Reflow Soldering Temperature | | | | 260 $^\circ\text{C}$ for 20 seconds | | | | |

Notes:

1. See Figure 5 for current derating vs. ambient temperature. Derating is not applicable to resistor lamps.
2. Refer to Figure 6 showing Max. Tolerable Peak Current vs. Pulse Duration to establish pulsed operating conditions.
3. The transient peak current is the maximum non-recurring peak current the device can withstand without failure. Do not operate these lamps at this high current.

Electrical/Optical Characteristics, $T_A = 25^\circ\text{C}$

Standard Red

| Device HLMP- | Parameter | Symbol | Min. | Typ. | Max. | Units | Test Conditions |
|-----------------|--|-------------------------|------|------|------|--------------------|--------------------------------|
| 6000-E00xx | | | 0.63 | 1.2 | | | |
| 6000-G00xx | Luminous Intensity ^[1] | I_V | 1.60 | 3.2 | | mcd | $I_F = 10\text{ mA}$ |
| P005-F00xx | | | 1.0 | 2.5 | | | |
| All | Forward Voltage | V_F | 1.4 | 1.6 | 2.0 | V | $I_F = 10\text{ mA}$ |
| | Reverse Breakdown Voltage | V_R | 5.0 | 12.0 | | V | $I_R = 100\text{ }\mu\text{A}$ |
| 6000 | Included Angle Between Half Intensity Points ^[2] | $2\theta^{1/2}$ | | 90 | | Deg. | |
| P005 | | | | 125 | | | |
| All | Peak Wavelength | λ_{PEAK} | | 655 | | nm | |
| | Dominant Wavelength ^[3] | λ_d | | 640 | | nm | |
| | Spectral Line Half Width | $\Delta\lambda_{1/2}$ | | 24 | | nm | |
| | Speed of Response | τ_s | | 15 | | ns | |
| | Capacitance | C | | 100 | | pF | $V_F = 0; f = 1\text{ MHz}$ |
| | Thermal Resistance | $R\theta_{J-PIN}$ | | 170 | | $^\circ\text{C/W}$ | Junction-to-Cathode Lead |
| | Luminous Efficacy ^[4] | η_V | | 65 | | lm/W | |

DH AS AlGaAs Red

| Device HLMP- | Parameter | Symbol | Min. | Typ. | Max. | Units | Test Conditions | |
|-----------------|--|-------------------------|------|------|------|----------------------|---|----------------------|
| P102-F00xx | Luminous Intensity | I_V | 1.0 | 20.0 | | mcd | $I_F = 20 \text{ mA}$ | |
| P105-L00xx | | | 10.0 | 30.0 | | | | |
| P105-NP000 | | | 25 | | 80 | | | |
| Q100-M00xx | | | 16 | 45 | | | | |
| Q100-N00xx | | | 25.0 | 45.0 | | | | |
| Q100-PQ000 | | | 40 | | 125 | | | |
| Q105-P00xx | | | 40 | 200 | | | | |
| Q105-ST000 | | | 160 | | 500 | | | |
| Q150-F00xx | | | 1.0 | 1.8 | | | | $I_F = 1 \text{ mA}$ |
| Q155-F00xx | | | 1.0 | 4.0 | | | | |
| Q100 | Forward Voltage | V_F | | 1.8 | 2.2 | V | $I_F = 20 \text{ mA}$ | |
| Q150/Q155 | | | | 1.6 | 1.8 | | $I_F = 1 \text{ mA}$ | |
| All | Reverse Breakdown Voltage | V_R | 5.0 | 15.0 | | V | $I_R = 100 \mu\text{A}$ | |
| P105 | Included Angle Between Half Intensity Points ^[2] | $2\theta^{1/2}$ | | 125 | | Deg. | | |
| Q100/Q150 | | | | 90 | | | | |
| Q105/Q155 | | | | 28 | | | | |
| | Peak Wavelength | λ_{PEAK} | | 645 | | nm | Measured at Peak | |
| | Dominant Wavelength ^[3] | λ_d | | 637 | | nm | | |
| | Spectral Line Half Width | $\Delta\lambda_{1/2}$ | | 20 | | nm | | |
| All | Speed of Response | τ_s | | 30 | | ns | Exponential Time Constant; e^{-t/τ_s} | |
| | Capacitance | C | | 30 | | pF | $V_F = 0$; $f = 1 \text{ MHz}$ | |
| | Thermal Resistance | $R\theta_{J-PIN}$ | | 170 | | $^{\circ}\text{C/W}$ | Junction-to Cathode Lead | |
| | Luminous Efficacy ^[4] | η_V | | 80 | | lm/W | | |

High Efficiency Red

| Device HLMP- | Parameter | Symbol | Min. | Typ. | Max. | Units | Test Conditions | |
|-----------------|--|-------------------------|------|------|------|----------------------|------------------------------|---------------------------|
| P202-F00xx | Luminous Intensity ^[1] | I_V | 1.0 | 5.0 | | mcd | $I_F = 10 \text{ mA}$ | |
| P205-F00xx | | | 1.0 | 8.0 | | | | |
| P205-JK000 | | | 4.0 | | 12.5 | | | |
| 6300-F00xx | | | 1.0 | 10.0 | | | | |
| 6300-KL000 | | | 6.3 | | 20.0 | | | |
| 6305-L00xx | | | 10.0 | 40.0 | | | | |
| 7000-D00xx | | | 0.4 | 1.0 | | | | $I_F = 2 \text{ mA}$ |
| 6600-G00xx | | | 1.6 | 5.0 | | | | $V_F = 5.0 \text{ Volts}$ |
| 6620-F00xx | | | 1.0 | 2.0 | | | | |
| All | Forward Voltage (Nonresistor Lamps) | V_F | 1.5 | 1.8 | 3.0 | V | $I_F = 10 \text{ mA}$ | |
| 6600 | Forward Current (Resistor Lamps) | I_F | | 9.6 | 13.0 | mA | $V_F = 5.0 \text{ V}$ | |
| 6620 | | | | 3.5 | 5.0 | | | |
| All | Reverse Breakdown Voltage | V_R | 5.0 | 30.0 | | V | $I_R = 100 \mu\text{A}$ | |
| P205 | Included Angle Between Half Intensity Points ^[2] | $2\theta^{1/2}$ | | 125 | | Deg. | | |
| 6305 | | | | 28 | | | | |
| All Diffused | | | | 90 | | | | |
| All | Peak Wavelength | λ_{PEAK} | | 635 | | nm | Measured at Peak | |
| | Dominant Wavelength ^[3] | λ_d | | 626 | | nm | | |
| | Spectral Line Half Width | $\Delta\lambda_{1/2}$ | | 40 | | nm | | |
| | Speed of Response | τ_s | | 90 | | ns | | |
| | Capacitance | C | | 11 | | pF | $V_F = 0; f = 1 \text{ MHz}$ | |
| | Thermal Resistance | $R\theta_{J-PIN}$ | | 170 | | $^{\circ}\text{C/W}$ | Junction-to-Cathode Lead | |
| | Luminous Efficacy ^[4] | η_V | | 145 | | lm/W | | |

Orange

| Device HLMP- | Parameter | Symbol | Min. | Typ. | Max. | Units | Test Conditions |
|-----------------|--------------------------------------|--------------------------|------|------|------|----------------------|------------------------------|
| P402-F00xx | Luminous Intensity | I_V | 1.0 | 4.0 | | mcd | $I_F = 10 \text{ mA}$ |
| P405-F00xx | | | 1.0 | 6 | | | |
| P405-JK000 | | | 4.0 | | 12.5 | | |
| Q400-F00xx | | | 1.0 | 8 | | | |
| Q405-H00xx | | | 2.5 | 14 | | | |
| All | Forward Voltage | V_F | 1.5 | 1.9 | 3.0 | V | $I_F = 10 \text{ mA}$ |
| | Reverse Breakdown Voltage | V_R | 5.0 | 30.0 | | V | $I_R = 100 \mu\text{A}$ |
| P40x | Included Angle Between | $2\theta^{1/2}$ | | 125 | | Deg. | |
| Q40x | Half Intensity Points ^[2] | | | 90 | | | |
| | Peak Wavelength | λ_{PEAK} | | 600 | | nm | |
| | Dominant Wavelength ^[3] | λ_d | | 602 | | nm | Measured at Peak |
| | Spectral Line Half Width | $\Delta\lambda_{1/2}$ | | 40 | | nm | |
| All | Speed of Response | τ_s | | 260 | | ns | |
| | Capacitance | C | | 4 | | pF | $V_F = 0; f = 1 \text{ MHz}$ |
| | Thermal Resistance | $R\theta_{\text{J-PIN}}$ | | 170 | | $^{\circ}\text{C/W}$ | Junction-to-Cathode Lead |
| | Luminous Efficacy ^[4] | η_V | | 380 | | lm/W | |

Yellow

| Device HLMP- | Parameter | Symbol | Min. | Typ. | Max. | Units | Test Conditions | |
|-----------------|--|-----------------------|------|------|------|----------------------|------------------------------|---------------------------|
| P302-F00xx | Luminous Intensity ^[1] | I_V | 1.0 | 3.0 | | mcd | $I_F = 10 \text{ mA}$ | |
| P305-F00xx | | | 1.0 | 4.0 | | | | |
| 6400-F00xx | | | 1.0 | 9.0 | | | | |
| 6400-JK000 | | | 4.0 | | 12.5 | | | |
| 6405-J00xx | | | 3.6 | 20 | | | | |
| 6405-MN0xx | | | 16 | | 50 | | | |
| 7019-D00xx | | | 0.4 | 0.6 | | | | $I_F = 2 \text{ mA}$ |
| 6700-G00xx | | | 1.4 | 5.0 | | | | $V_F = 5.0 \text{ Volts}$ |
| 6720-F00xx | | | 0.9 | 2.0 | | | | |
| All | Forward Voltage (Nonresistor Lamps) | V_F | | 2.0 | 2.4 | V | $I_F = 10 \text{ mA}$ | |
| 6700 | Forward Current (Resistor Lamps) | I_F | | 9.6 | 13.0 | mA | $V_F = 5.0 \text{ V}$ | |
| 6720 | | | | 3.5 | 5.0 | | | |
| All | Reverse Breakdown Voltage | V_R | 5.0 | 50.0 | | V | | |
| P305 | Included Angle Between | | | 125 | | | | |
| 6405 | Half Intensity Points ^[2] | $2\theta^{1/2}$ | | 28 | | Deg. | | |
| All Diffused | | | | 90 | | | | |
| All | Peak Wavelength | λ_{PEAK} | | 583 | | nm | Measured at Peak | |
| | Dominant Wavelength ^[3] | λ_d | | 585 | | nm | | |
| | Spectral Line Half Width | $\Delta\lambda_{1/2}$ | | 36 | | nm | | |
| | Speed of Response | τ_s | | 90 | | ns | | |
| | Capacitance | C | | 15 | | pF | $V_F = 0; f = 1 \text{ MHz}$ | |
| | Thermal Resistance | $R\theta_{J-PIN}$ | | 170 | | $^{\circ}\text{C/W}$ | Junction-to-Cathode Lead | |
| | Luminous Efficacy ^[4] | η_V | | 500 | | lm/W | | |

High Performance Green

| Device HLMP- | Parameter | Symbol | Min. | Typ. | Max. | Units | Test Conditions | |
|-----------------|--|-------------------------|------|------|------|----------------------|------------------------------|---------------------------|
| P502-F00xx | Luminous Intensity ^[1] | I_v | 1.0 | 3.0 | | mcd | $I_F = 10 \text{ mA}$ | |
| P505-G00xx | | | 1.6 | 6.3 | | | | |
| 6500-F00xx | | | 1.0 | 7.0 | | | | |
| 6505-L00xx | | | 10.0 | 40.0 | | | | |
| 7040-D00xx | | | 0.4 | 0.6 | | | | $I_F = 2 \text{ mA}$ |
| 6800-G00xx | | | 1.6 | 5.0 | | | | $V_F = 5.0 \text{ Volts}$ |
| 6820-F00xx | | | 1.0 | 2.0 | | | | |
| All | Forward Voltage (Nonresistor Lamps) | V_F | | 2.1 | 2.7 | V | $I_F = 10 \text{ mA}$ | |
| 6800 | Forward Current (Resistor Lamps) | I_F | | 9.6 | 13.0 | mA | $V_F = 5.0 \text{ V}$ | |
| 6820 | | | | 3.5 | 5.0 | | | |
| All | Reverse Breakdown Voltage | V_R | 5.0 | 50.0 | | V | $I_R = 100 \mu\text{A}$ | |
| P505 | Included Angle Between | | | 125 | | | | |
| 6505 | Half Intensity Points ^[2] | $2\theta^{1/2}$ | | 28 | | Deg. | | |
| All Diffused | | | | 90 | | | | |
| All | Peak Wavelength | λ_{PEAK} | | 565 | | nm | | |
| | Dominant Wavelength ^[3] | λ_d | | 569 | | nm | | |
| | Spectral Line Half Width | $\Delta\lambda_{1/2}$ | | 28 | | nm | | |
| All | Speed of Response | τ_s | | 500 | | ns | | |
| | Capacitance | C | | 18 | | pF | $V_F = 0; f = 1 \text{ MHz}$ | |
| | Thermal Resistance | $R\theta_{J-PIN}$ | | 170 | | $^{\circ}\text{C/W}$ | Junction-to-Cathode Lead | |
| | Luminous Efficacy ^[4] | η_v | | 595 | | lm/W | | |

Notes:

1. The luminous intensity for arrays is tested to assure a 2.1 to 1.0 matching between elements. The average luminous intensity for an array determines its light output category bin. Arrays are binned for luminous intensity to allow I_v matching between arrays.
2. $\theta^{1/2}$ is the off-axis angle where the luminous intensity is half the on-axis value.
3. Dominant wavelength, λ_d , is derived from the CIE Chromaticity Diagram and represents the single wavelength that defines the color of the device.
4. Radiant intensity, I_e , in watts/steradian, may be calculated from the equation $I_e = I_v/\eta_v$, where I_v is the luminous intensity in candelas and η_v is the luminous efficacy in lumens/watt.

Emerald Green^[1]

| Device HLMP- | Parameter | Symbol | Min. | Typ. | Max. | Units | Test Conditions |
|-----------------|--------------------------------------|-------------------------|------|------|------|----------------------|------------------------------|
| P605-F00xx | | | 1.0 | 1.5 | | | |
| Q600-F00xx | Luminous Intensity | I_V | 1.0 | 1.5 | | mcd | $I_F = 10 \text{ mA}$ |
| Q605-F00xx | | | 1.0 | 7.5 | | | |
| All | Forward Voltage | V_F | | 2.2 | 3.0 | V | $I_F = 10 \text{ mA}$ |
| | Reverse Breakdown Voltage | V_R | 5.0 | | | V | $I_R = 100 \mu\text{A}$ |
| P605 | Included Angle Between | $2\theta^{1/2}$ | | 125 | | Deg. | |
| Q60x | Half Intensity Points ^[2] | | | 90 | | | |
| P605/Q600 | Peak Wavelength | λ_{PEAK} | | 558 | | nm | |
| | Dominant Wavelength ^[3] | λ_d | | 560 | | nm | Measured at Peak |
| | Spectral Line Half Width | $\Delta\lambda_{1/2}$ | | 24 | | nm | |
| P605/Q600 | Speed of Response | τ_s | | 3100 | | ns | |
| | Capacitance | C | | 35 | | pF | $V_F = 0; f = 1 \text{ MHz}$ |
| | Thermal Resistance | $R\theta_{J-PIN}$ | | 170 | | $^{\circ}\text{C/W}$ | Junction-to-Cathode Lead |
| | Luminous Efficacy ^[4] | η_V | | 656 | | lm/W | |

Note:

1. Please refer to Application Note 1061 for information comparing standard green and emerald green light output degradation.

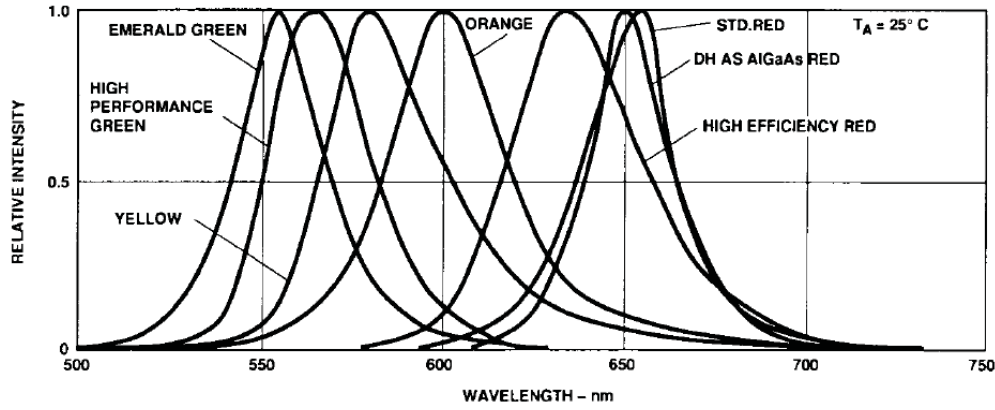

Figure 1. Relative intensity vs. wavelength.

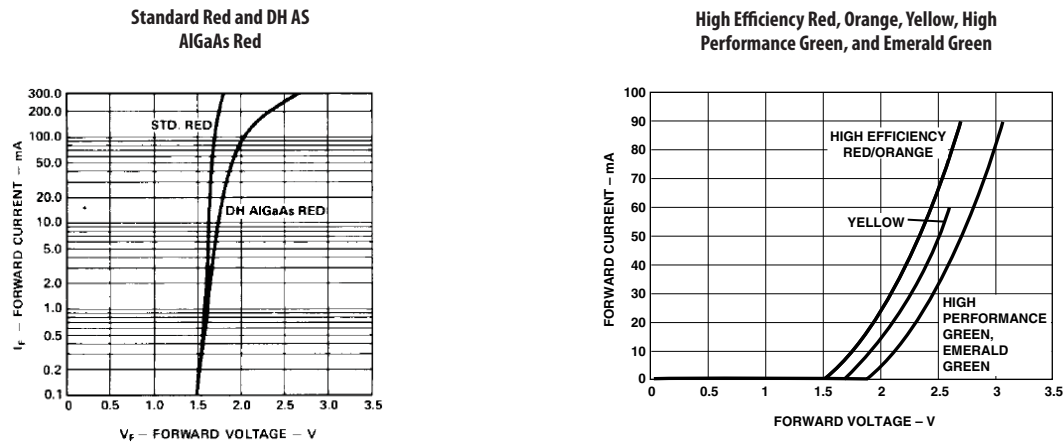

Figure 2. Forward current vs. forward voltage (non-resistor lamp).

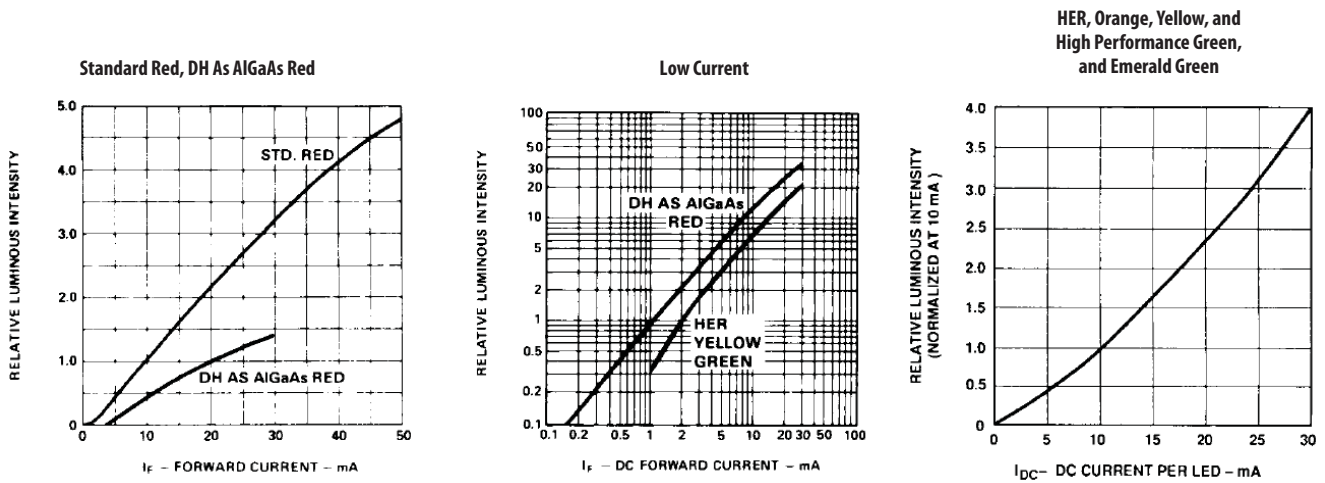

Figure 3. Relative luminous intensity vs. forward current (non-resistor lamp).

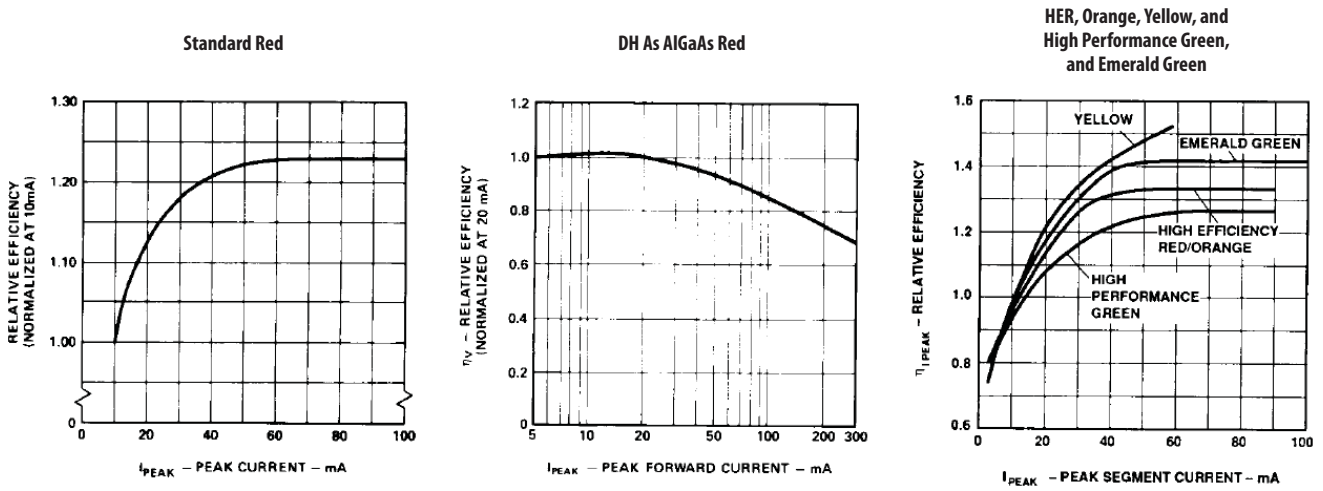

Figure 4. Relative efficiency (luminous intensity per unit current) vs. peak current (non-resistor lamps).

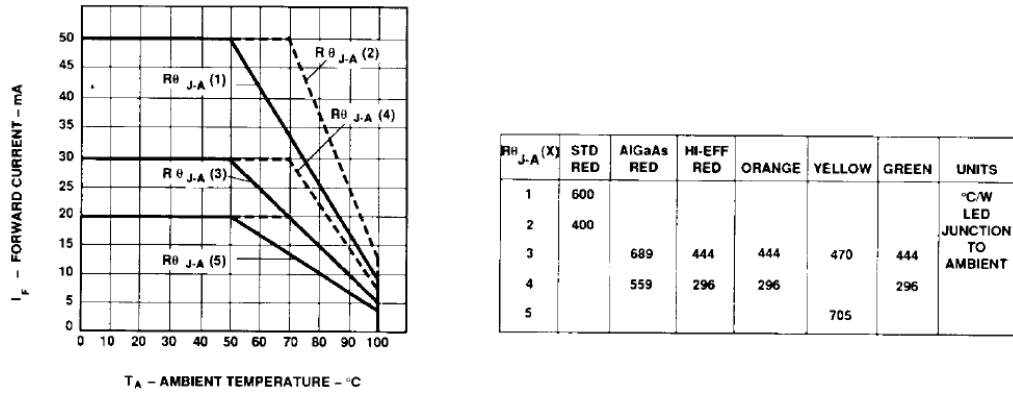

Figure 5. Maximum forward dc current vs. ambient temperature. Derating based on T_J MAX = 110°C (non-resistor lamps).

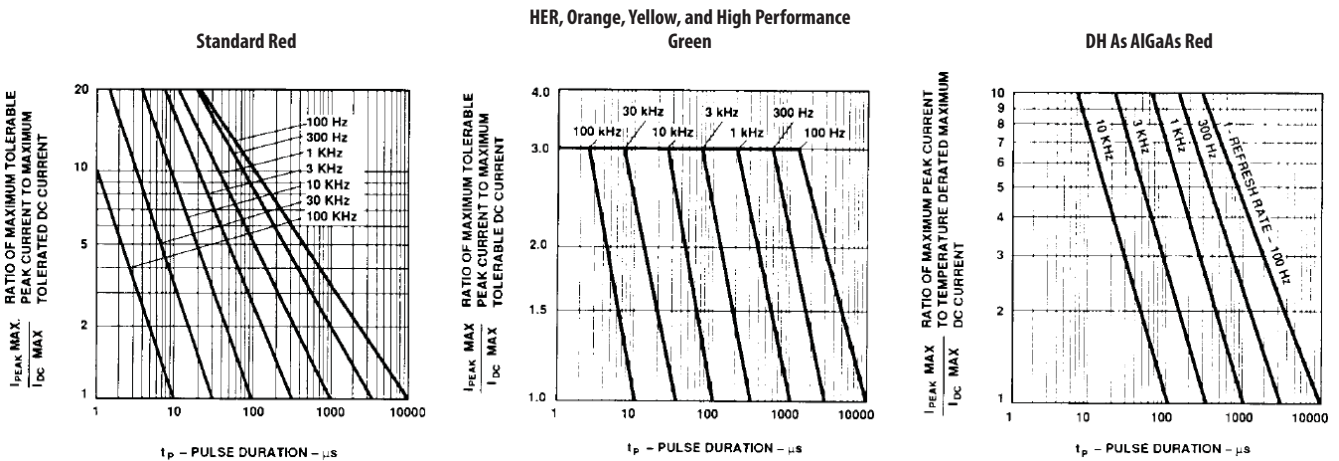

Figure 6. Maximum tolerable peak current vs. pulse duration (I_{DC} MAX as per MAX ratings) (non-resistor lamps).

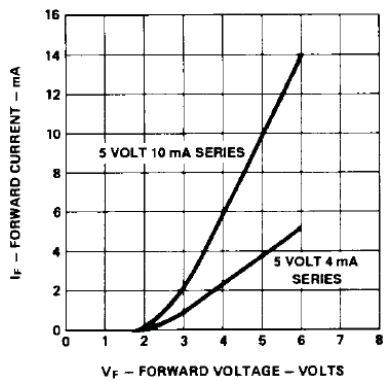

Figure 7. Resistor lamp forward current vs. forward voltage.

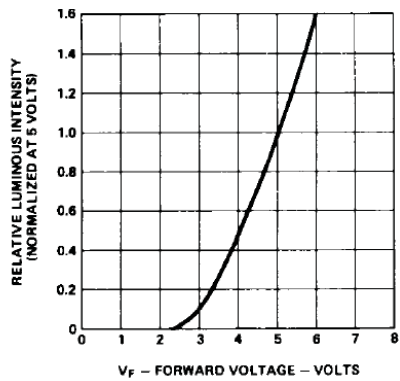

Figure 8. Resistor lamp luminous intensity vs. forward voltage.

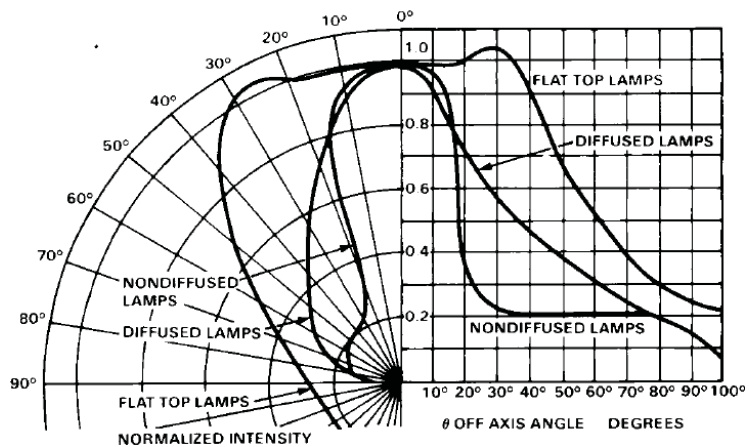
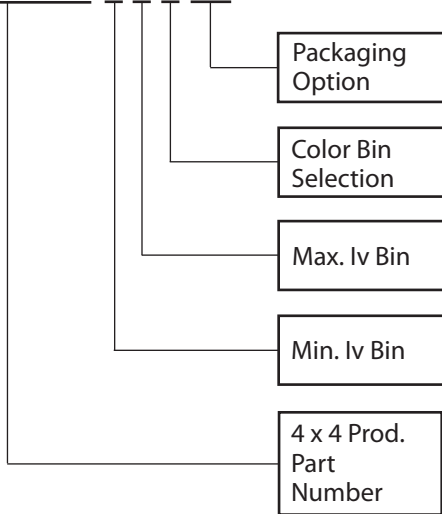

Figure 9. Relative intensity vs. angular displacement.

Ordering Information

HLM_x-XXXX-X X X X X



Intensity Bin Limits

| Bin | Min. | Max. |
|-----|---------|---------|
| A | 0.10 | 0.20 |
| B | 0.16 | 0.32 |
| C | 0.25 | 0.50 |
| D | 0.40 | 0.80 |
| E | 0.63 | 1.25 |
| F | 1.00 | 2.00 |
| G | 1.60 | 3.20 |
| H | 2.50 | 5.00 |
| J | 4.00 | 8.00 |
| K | 6.30 | 12.50 |
| L | 10.00 | 20.00 |
| M | 16.00 | 32.00 |
| N | 25.00 | 50.00 |
| P | 40.00 | 80.00 |
| Q | 63.00 | 125.00 |
| R | 100.00 | 200.00 |
| S | 160.00 | 320.00 |
| T | 250.00 | 500.00 |
| U | 400.00 | 800.00 |
| V | 630.00 | 1250.00 |
| W | 1000.00 | 2000.00 |
| X | 1600.00 | 3200.00 |
| Y | 2500.00 | 5000.00 |

Color Bin Limits

| Package | Bin | Min. | Max. |
|---------------|-----|-------------------|-------|
| Emerald Green | 0 | Full Distribution | |
| | 9 | 552 | 556 |
| | 8 | 555 | 559 |
| | 7 | 558 | 562 |
| | 6 | 561 | 565 |
| Green | 0 | Full Distribution | |
| | 6 | 561 | 565 |
| | 5 | 564 | 568 |
| | 4 | 567 | 571 |
| | 3 | 570 | 574 |
| | 2 | 573 | 577 |
| | 0 | Full Distribution | |
| Yellow | 0 | Full Distribution | |
| | 1 | 581.5 | 585.0 |
| | 3 | 584.0 | 587.5 |
| | 2 | 586.5 | 590.0 |
| | 4 | 589.0 | 592.5 |
| | 5 | 591.5 | 593.5 |
| | 6 | 591.5 | 595.0 |
| | 7 | 594.0 | 597.5 |
| Orange | 0 | Full Distribution | |
| | 1 | 596.5 | 600.0 |
| | 2 | 599.0 | 602.5 |
| | 3 | 601.5 | 604.0 |
| | 4 | 603.8 | 608.2 |
| | 5 | 606.8 | 611.2 |
| | 6 | 609.8 | 614.2 |
| | 7 | 612.8 | 617.2 |
| | 8 | 615.8 | 620.2 |

Mechanical Option

| | |
|----|---|
| 00 | Straight Leads, Bulk Packaging, Quantity of 500 Parts |
| 10 | Right Angle Housing, Bulk Packaging, Quantity of 500 Parts |
| 11 | Gull Wing Leads, 12 mm Tape on 7 in. Dia. Reel, 1500 Parts per Reel |
| 12 | Gull Wing Lead, Bulk Packaging, Quantity of 500 Parts |
| 14 | Gull Wing Leads, 12 mm Tape on 13 in. Dia. Reel, 6000 Parts per Reel |
| 21 | Yoke Leads, 12 mm Tape on 7 in. Dia. Reel, 1500 Parts per Reel |
| 22 | Yoke Leads, Bulk Packaging, Quantity of 500 Parts |
| 24 | Yoke Leads, 12 mm Tape on 13 in. Dia. Reel, 6000 Parts per Reel |
| 31 | Z-Bend Leads, 12 mm Tape on 7 in. Dia. Reel, 1500 Parts per Reel |
| 32 | Z-Bend Leads, Bulk Packaging, Quantity of 500 Parts |
| 34 | Z-Bend Leads, 12 mm Tape on 13 in. Dia. Reel, 6000 Parts per Reel |
| 1L | 2.54 mm (0.100 inch) Center Lead Spacing, Long Leads; 10.4 mm (0.410 in.) |
| 1S | 2.54 mm (0.100 inch) Center Lead Spacing, Short Leads; 3.7 mm (0.145 in.) |
| 2L | 5.08 mm (0.200 inch) Center Lead Spacing, Long Leads; 10.4 mm (0.410 in.) |
| 2S | 5.08 mm (0.200 inch) Center Lead Spacing, Short Leads; 3.7 mm (0.145 in.) |

Note:

All Categories are established for classification of products. Products may not be available in all categories. Please contact your local Avago representative for further clarification/information.

For product information and a complete list of distributors, please go to our web site: www.avagotech.com

Avago, Avago Technologies, and the A logo are trademarks of Avago Technologies in the United States and other countries. Data subject to change. Copyright © 2005-2012 Avago Technologies. All rights reserved. Obsoletes 5989-1708EN AV02-3609EN - June 12, 2012

