

## Features

- RoHS compliant\* (see How to Order "Termination" option)
- Standard E.I.A. package compatible with automatic placement equipment
- Tape and reel packaging standard
- Custom circuits are available
- Compliant leads to reduce solder joint fatiguing
- Standard electrical schematics: isolated, bussed, dual terminator
- Now available with improved tolerance to  $\pm 0.5\%$

## 4800P Series - Thick Film Surface Mounted Medium Body

### Product Characteristics

Resistance Range ..... 10 ohms to 2.2 megohms  
 Maximum Operating Voltage ..... 50 V  
 Temperature Coefficient of Resistance  
 50  $\Omega$  and above .....  $\pm 100$  ppm/ $^{\circ}\text{C}$   
 below 50  $\Omega$  .....  $\pm 250$  ppm/ $^{\circ}\text{C}$   
 TCR Tracking  
 (for equal values within a package)  
 ..... 50 ppm/ $^{\circ}\text{C}$  max. for values > 50  $\Omega$ ;  
 ..... 100 ppm/ $^{\circ}\text{C}$  for values  $\leq$  50  $\Omega$   
 Operating Temperature  
 ..... -55  $^{\circ}\text{C}$  to +125  $^{\circ}\text{C}$   
 Insulation Resistance  
 ..... 10,000 megohms min.  
 Dielectric Withstanding Voltage  
 ..... 200 VRMS  
 Lead Solderability ..... Meet requirements  
 of MIL-STD-202 Method 208

### Environmental Characteristics

TESTS PER MIL-STD-202 .....  $\Delta R$  MAX.  
 Short Time Overload .....  $\pm 0.25\%$   
 Load Life .....  $\pm 1.00\%$   
 Moisture Resistance .....  $\pm 0.50\%$   
 Resistance to Soldering Heat .....  $\pm 0.25\%$   
 Thermal Shock .....  $\pm 0.25\%$

### Physical Characteristics

Flammability ..... Conforms to UL94V-0  
 Lead Frame Material  
 ..... Copper, solder coated  
 Body Material ..... Thermoplastic

### How To Order

**48 16 P - 1 - 103**

Model (48 = SOM Pkg.)  
 Number of Pins  
 Electrical Configuration  
 • 1 or 4 = Isolated\*  
 • 2 = Bussed\*  
 • 3 = Dual Terminator\*  
 Resistance Code  
 • First 2 digits are significant  
 • Third digit represents the number of zeros to follow.  
 Resistance Tolerance  
 • Blank =  $\pm 2\%$  (see "Resistance Tolerance" on next page for resistance range)  
 • F =  $\pm 1\%$  (100 ohms - 1 megohm)  
 • D =  $\pm 0.5\%$  (100 ohms - 1 megohm)  
 Terminations  
 • All electrical configurations EXCEPT T03:  
 LF = RoHS compliant  
 • ONLY electrical configuration T03:  
 L = RoHS compliant  
 • Blank = Tin/Lead-plated

\*For tube packaging, use T01, T02, T03 or T04. Consult factory for other available options.

### Package Power Temp. Derating Curve

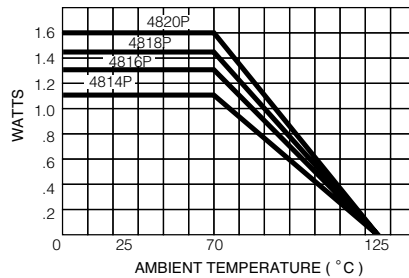

### Package Power Rating at 70 $^{\circ}\text{C}$

|       |            |
|-------|------------|
| 4814P | 1.12 watts |
| 4816P | 1.28 watts |
| 4818P | 1.44 watts |
| 4820P | 1.60 watts |

### Typical Part Marking

Represents total content. Layout may vary.

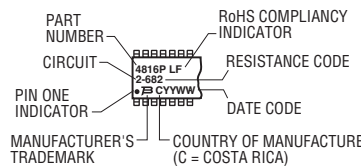

### Recommended Land Pattern

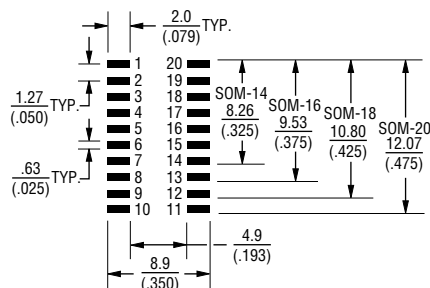

NOTE: Land pattern dimensions are based on design rules established by the Institute for Interconnecting and Packaging Electronic Circuits in IPC-SM-782.

For Standard Values Used in Capacitors, Inductors, and Resistors, [click here](#).

### Product Dimensions

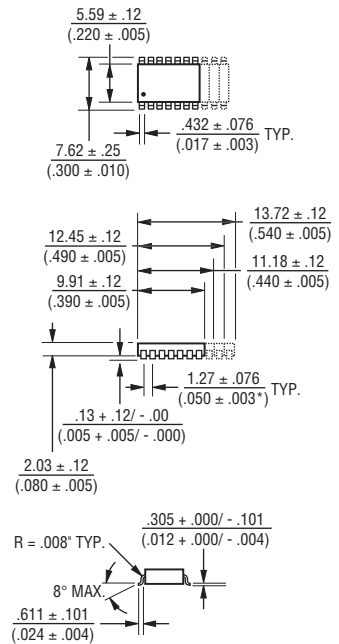

Lead coplanarity .102mm (.004 inch) max. at mounting surface.

Governing dimensions are in metric. Dimensions in parentheses are inches and are approximate.

\*Terminal centerline to centerline measurements made at point of emergence of the lead from the body.

\*RoHS Directive 2002/95/EC Jan. 27, 2003 including annex and RoHS Recast 2011/65/EU June 8, 2011.

Specifications are subject to change without notice.

The device characteristics and parameters in this data sheet can and do vary in different applications and actual device performance may vary over time.

Users should verify actual device performance in their specific applications.

For information on specific applications, download Bourns' application notes:

- DRAM Applications
- Dual Terminator Resistor Networks
- R/2R Ladder Networks
- SCSI Applications

# 4800P Series - Thick Film Surface Mounted Medium Body BOURNS®

### Isolated Resistors (1 and 4 Circuits)

**Model 4814P-1**  
**Model 4816P-1 (Shown)**  
**Model 4818P-1**  
**Model 4820P-1**

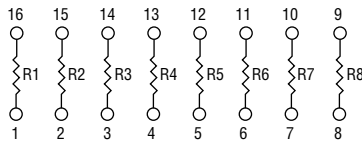

**Model 4816P-4 (Shown)**  
**Model 4820P-4**

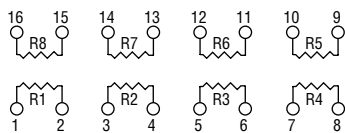

#### Resistance Tolerance

10 ohms to 49 ohms ..... ±1 ohm  
 50 ohms to 2.2 megohms ..... ±2 %\*

#### Power Rating per Resistor

1 Circuit at 70 °C ..... 0.160 watt  
 4 Circuit at 70 °C ..... 0.160 watt

### Bussed Resistors (2 Circuit)

**Model 4814P-2**  
**Model 4816P-2 (Shown)**  
**Model 4818P-2**  
**Model 4820P-2**

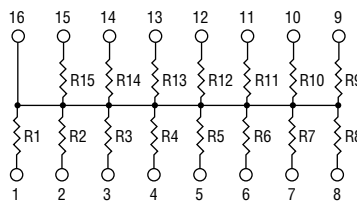

#### Resistance Tolerance

10 ohms to 49 ohms ..... ±1 ohm  
 50 ohms to 2.2 megohms ..... ±2 %\*

#### Power Rating per Resistor

2 Circuit at 70 °C ..... 0.080 watt

### Dual Terminator (3 Circuit)

**Model 4814P-3**  
**Model 4816P-3 (Shown)**  
**Model 4818P-3**  
**Model 4820P-3**

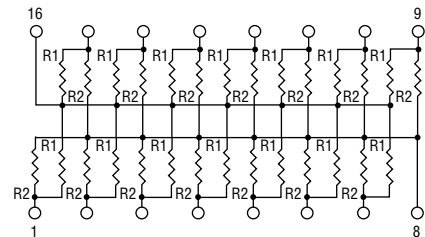

#### Resistance Tolerance

Below 100 ohms ..... ±2 ohms  
 100 ohms to 2.2 megohms ..... ±2 %\*

#### Power Rating per Resistor

3 Circuit at 70 °C ..... 0.080 watt

### Resistor Power Temp. Derating Curve

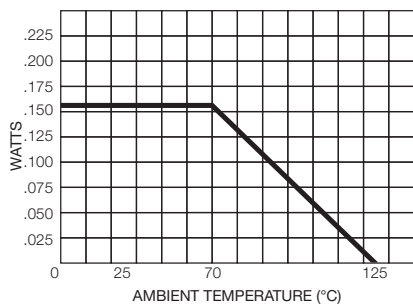

### Resistor Power Temp. Derating Curve

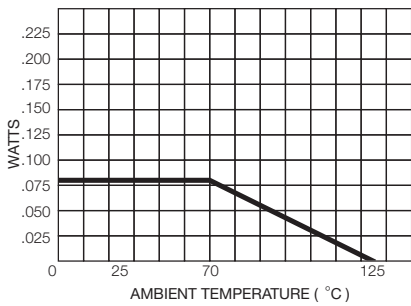

### Resistor Power Temp. Derating Curve

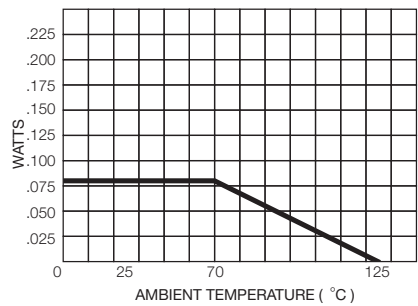

### Popular Resistance Values (1, 4 and 2 Circuits)\*\*

| Ohms | Code | Ohms  | Code | Ohms   | Code | Ohms    | Code | Ohms      | Code |
|------|------|-------|------|--------|------|---------|------|-----------|------|
| 10   | 100  | 180   | 181  | 1,800  | 182  | 15,000  | 153  | 120,000   | 124  |
| 22   | 220  | 220   | 221  | 2,000  | 202  | 18,000  | 183  | 150,000   | 154  |
| 27   | 270  | 270   | 271  | 2,200  | 222  | 20,000  | 203  | 180,000   | 184  |
| 33   | 330  | 330   | 331  | 2,700  | 272  | 22,000  | 223  | 220,000   | 224  |
| 39   | 390  | 390   | 391  | 3,300  | 332  | 27,000  | 273  | 270,000   | 274  |
| 47   | 470  | 470   | 471  | 3,900  | 392  | 33,000  | 333  | 330,000   | 334  |
| 56   | 560  | 560   | 561  | 4,700  | 472  | 39,000  | 393  | 390,000   | 394  |
| 68   | 680  | 680   | 681  | 5,600  | 562  | 47,000  | 473  | 470,000   | 474  |
| 82   | 820  | 820   | 821  | 6,800  | 682  | 56,000  | 563  | 560,000   | 564  |
| 100  | 101  | 1,000 | 102  | 8,200  | 822  | 68,000  | 683  | 680,000   | 684  |
| 120  | 121  | 1,200 | 122  | 10,000 | 103  | 82,000  | 823  | 820,000   | 824  |
| 150  | 151  | 1,500 | 152  | 12,000 | 123  | 100,000 | 104  | 1,000,000 | 105  |

### Popular Resistance Values (3 Circuit)\*\*

| Resistance |       |      |     |
|------------|-------|------|-----|
| Ohms       |       | Code |     |
| R1         | R2    | R1   | R2  |
| 160        | 240   | 161  | 241 |
| 180        | 390   | 181  | 391 |
| 220        | 270   | 221  | 271 |
| 220        | 330   | 221  | 331 |
| 330        | 390   | 331  | 391 |
| 330        | 470   | 331  | 471 |
| 3,000      | 6,200 | 302  | 622 |

REV. 07/13

\* Add "F" after resistance code for ±1 % tolerance available from 100 Ω through 1M Ω, or add "D" after resistance code for ±0.5 % tolerance available from 100 Ω through 1M Ω.  
 Part number suffix examples: -103 = 10K Ω, ±2 %; -103F = 10K Ω, ±1 %; -103D = 10K Ω, ±0.5 %  
 \*\* Non-standard values available, within resistance range.

Specifications are subject to change without notice. The device characteristics and parameters in this data sheet can and do vary in different applications and actual device performance may vary over time. Users should verify actual device performance in their specific applications.

# Surface Mounted Ordering Guide

**BOURNS®**

| Electrical Configuration | *Circuit Codes |       | Examples                                |
|--------------------------|----------------|-------|---|
|                          | Tape & Reel    | Tubes |   |
| Isolated                 | 1              | T01   | 4816P-1-101                             |
| Bussed                   | 2              | T02   | Isolated Circuit in Tape & Reel Package |
| Dual Terminated          | 3              | T03   | 4816P-T01-101                           |
| Adj. Isolated            | 4              | T04   | Isolated Circuit in Slide Tube Package  |

\*4816P-X-RC: To specify package type, replace "X" with appropriate "Circuit Code".

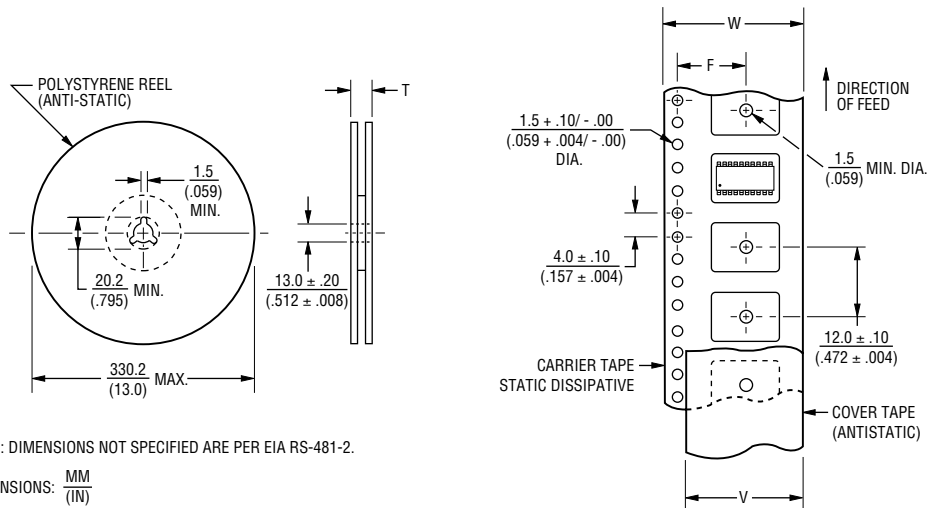

| Model | Standard Quantity per Reel | Carrier Tape Width (W)                 | Cover Tape Width (W)       | Reel Width (T)              | Pocket Center (F)                      |
|-------|----------------------------|--|----------------------------|-----------------------------|--|
| 4814P | 2,000                      | $\frac{24.0 \pm .30}{(.945 \pm .012)}$ | $\frac{21.0}{(.827)}$ NOM. | $\frac{30.4}{(1.197)}$ MAX. | $\frac{11.5 \pm .10}{(.453 \pm .004)}$ |
| 4816P |                            |  |                            |                             |  |
| 4818P |                            |  |                            |                             |  |
| 4820P |                            |  |                            |                             |  |

Leader Length = 500 min. } Empty Component Pockets  
 Trailer Length = 500 mm min. } Sealed with Cover Tape