

PLCC Lightbar Waterproof FPC Series Datasheet



Features :

- High Brightness SMD LED
- Low Power Requirement & Energy Efficient
- Suitable for Restricted Space
- Waterproof Level IP67

Typical Applications :

- Auditorium Walkway Lighting
- Stairway Accent Lighting
- Cabinet Lighting

Specification :

- Color : ○ ● ● ●



Table of Contents

General Information	3
Product Dimensions.....	4
Absolute Maximum Ratings	5
Electro-Optical Characteristics ($T_j=25^{\circ}\text{C}$).....	6
Package Dimension	7
Environmental Compliance	8
Application Notes.....	8
Revision History	9
About Edison Opto	9

General Information

Introduction

PLCC Lightbar Waterproof FPC is a strip of lighting module available in varying colors. Its flexible circuit board not only enables novel design thinking with bendable light source, but also offers a wide range of applications with dividable lighting segments.

Product Nomenclature

<u>6</u> X1		<u>L B U 1</u> X2		<u>X X</u> X3		<u>N</u> X4	<u>X</u> X5	<u>X X X X X X X</u> X6	
X1		X2		X3		X4		X5	
Type		Series		Emitter Color		Angle		Circuit	
6	--	LBU1	FPC Waterproof	CW	6000K	N	Lightbar	I	CV 12V
				NW	4000K			J	CV 24V
				WW	3000K				
				M1	RGB				
X6		Serial Number							
--	--								

Product Dimensions

6LBU1xxNI000000x Series Dimensions (3528 CV 12V)

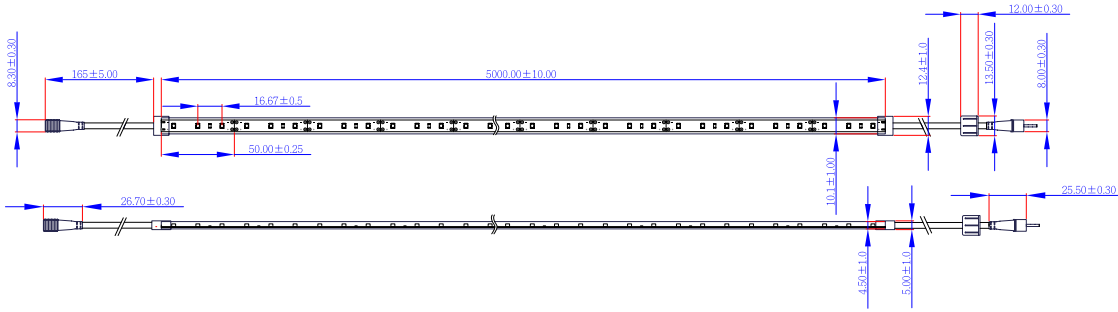

6LBU1xxNJ000000x Series Dimensions (3528 CV 24V)

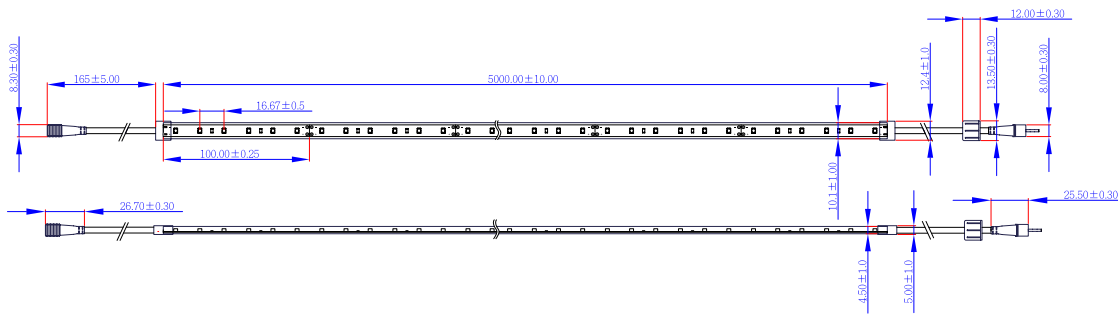

6LBU1xxNI0000002 Series Dimensions (5050 CV 12V)

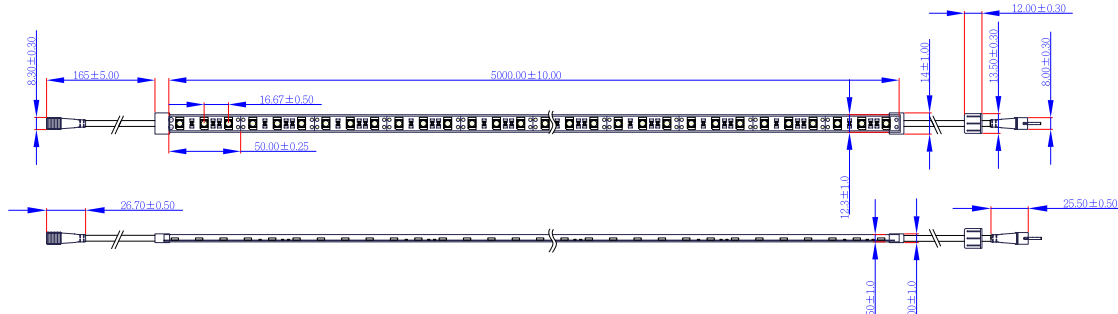

6LBU1xxNJ0000002 Series Dimensions (5050 CV 24V)

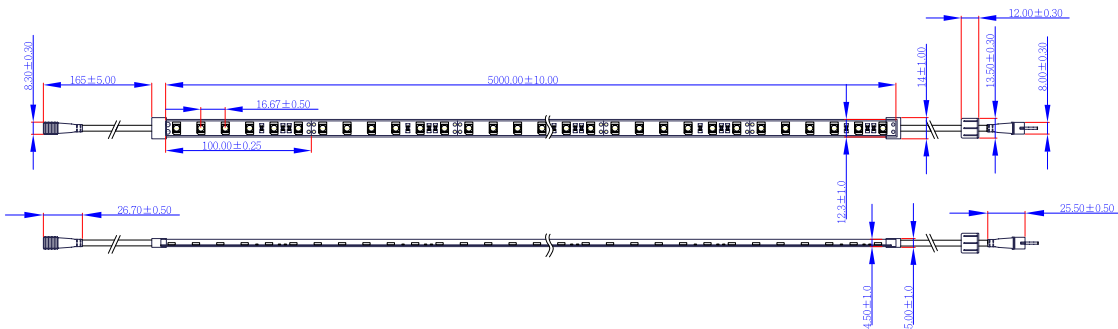

6LBU1M1NI0000001 Series Dimensions (5050RGB CV 12V)

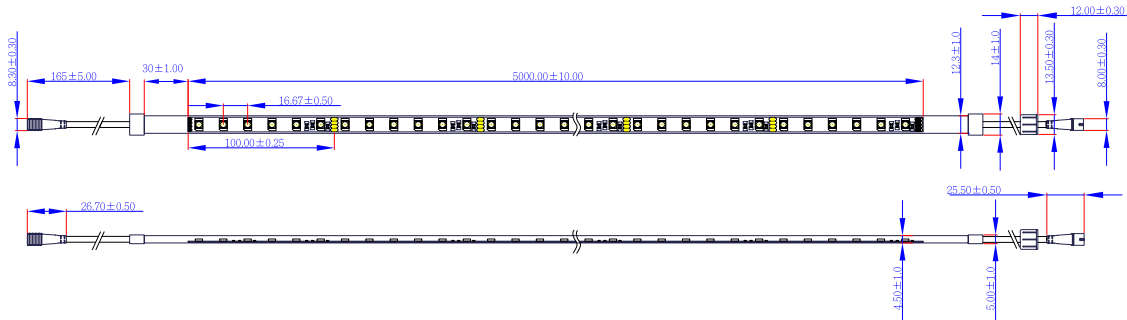

6LBU1M1NJ0000002 Series Dimensions (5050RGB CV 24V)

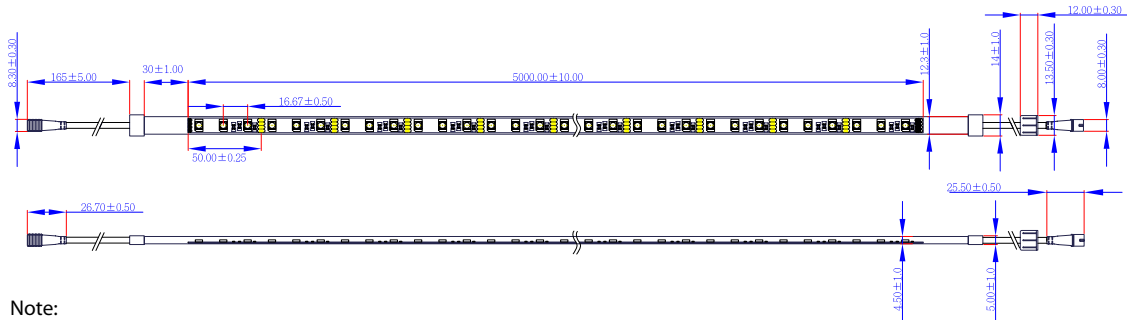

Note:
All dimensions are in millimeters.

Absolute Maximum Ratings

Parameter	Symbol	Rating	Units
LED junction Temperature	T_J	125	°C
Operating Temperature	T_{opr}	-20 ~ +50	°C
Storage Temperature	T_{stg}	-20 ~ +85	°C
Number of FPC Connection	--	5	M

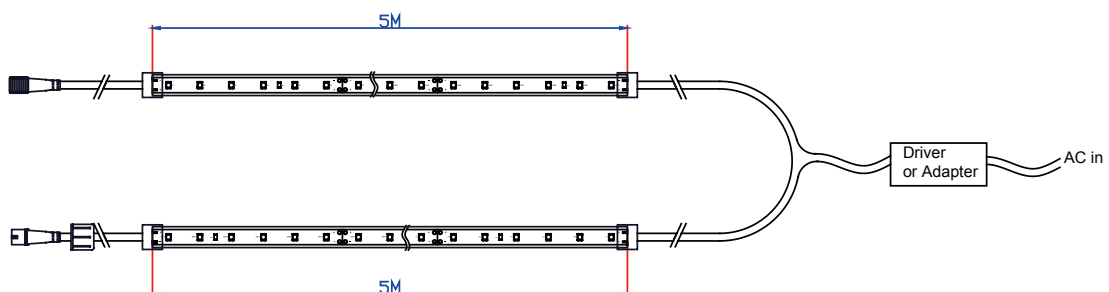

- Notes:
1. Proper current derating must be observed to maintain junction temperature below the maximum at all time.
 2. LEDs are not designed to be driven in reverse bias.
 3. Strongly recommended one power connection one set waterproof FPC, If over two set Waterproof FPC recommended connection one power between two waterproof FPC (Drawing).



Lighting Design Manufacturing Service

Electro-Optical Characteristics (T_j=25°C)

6LBU1xxNI0000001 Series (3528 CV 12V)

Order Code	Color	Number of LEDs(M)	Power (W/M)	Forward Current (mA/M)	Im(M)	Input Voltage (CV)	CCT(K)
6LBU1CWNIO000001	Cool White				245		6,500~9,000
6LBU1NWNIO000001	Neutral White	60	4.8	400	235	12	4,000~4,500
6LBU1WWNIO000001	Warm White				195		3,000~3,500

6LBU1xxNJ0000001 Series (3528 CV 24V)

Order Code	Color	Number of LEDs(M)	Power (W/M)	Forward Current (mA/M)	Im(M)	Input Voltage (CV)	CCT(K)
6LBU1CWNJ0000001	Cool White				245		6,500~9,000
6LBU1NWNJ0000001	Neutral White	60	4.8	200	235	24	4,000~4,500
6LBU1WWNJ0000001	Warm White				195		3,000~3,500

6LBU1xxNI0000002 Series (5050 CV 12V)

Order Code	Color	Number of LEDs(M)	Power (W/M)	Forward Current (mA/M)	Im(M)	Input Voltage (CV)	CCT(K)
6LBU1CWNIO0000002	Cool White				700		6,500~9,000
6LBU1NWNIO0000002	Neutral White	60	14.4	1,200	685	12	4,000~4,500
6LBU1WWNIO0000002	Warm White				585		3,000~3,500

6LBU1xxNJ0000002 Series (5050 CV 24V)

Order Code	Color	Number of LEDs(M)	Power (W/M)	Forward Current (mA/M)	Im(M)	Input Voltage (CV)	CCT(K)
6LBU1CWNJ0000002	Cool White				700		6,500~9,000
6LBU1NWNJ0000002	Neutral White	60	14.4	600	685	24	4,000~4,500
6LBU1WWNJ0000002	Warm White				585		3,000~3,500

6LBU1M1NI0000001 Series (5050 CV 12V)

Order Code	Color	Number of LEDs(M)	Power (W/M)	Forward Current (mA/M)	Im(M)	Input Voltage (CV)	CCT(K)
6LBU1M1NI0000001	Red				65		620~630
	Green	60	4.8	400	150	12	520~530
	Blue				30		465~475

6LBU1M1NJ0000002 Series (5050 CV 24V)

Order Code	Color	Number of LEDs(M)	Power (W/M)	Forward Current (mA/M)	Im(M)	Input Voltage (CV)	CCT(K)
6LBU1M1NJ0000002	Red				65		620~630
	Green	60	4.8	200	150	24	520~530
	Blue				30		465~475

Notes:

1. Flux is measured with an accuracy of ± 10%.
2. Forward Current is measured with an accuracy of ± 10%

Package Dimension

Package Type	Order Code	6LBU1xxNx000000x	Dimension
Antistatic bag		1 Reel	260mm x 230mm
Inside box		3 Antistatic bags	240mm x 235mm x 67mm
Outside box		10 Inside boxes	488mm x 364mm x 261mm

PLCC lightbar FPC material Description

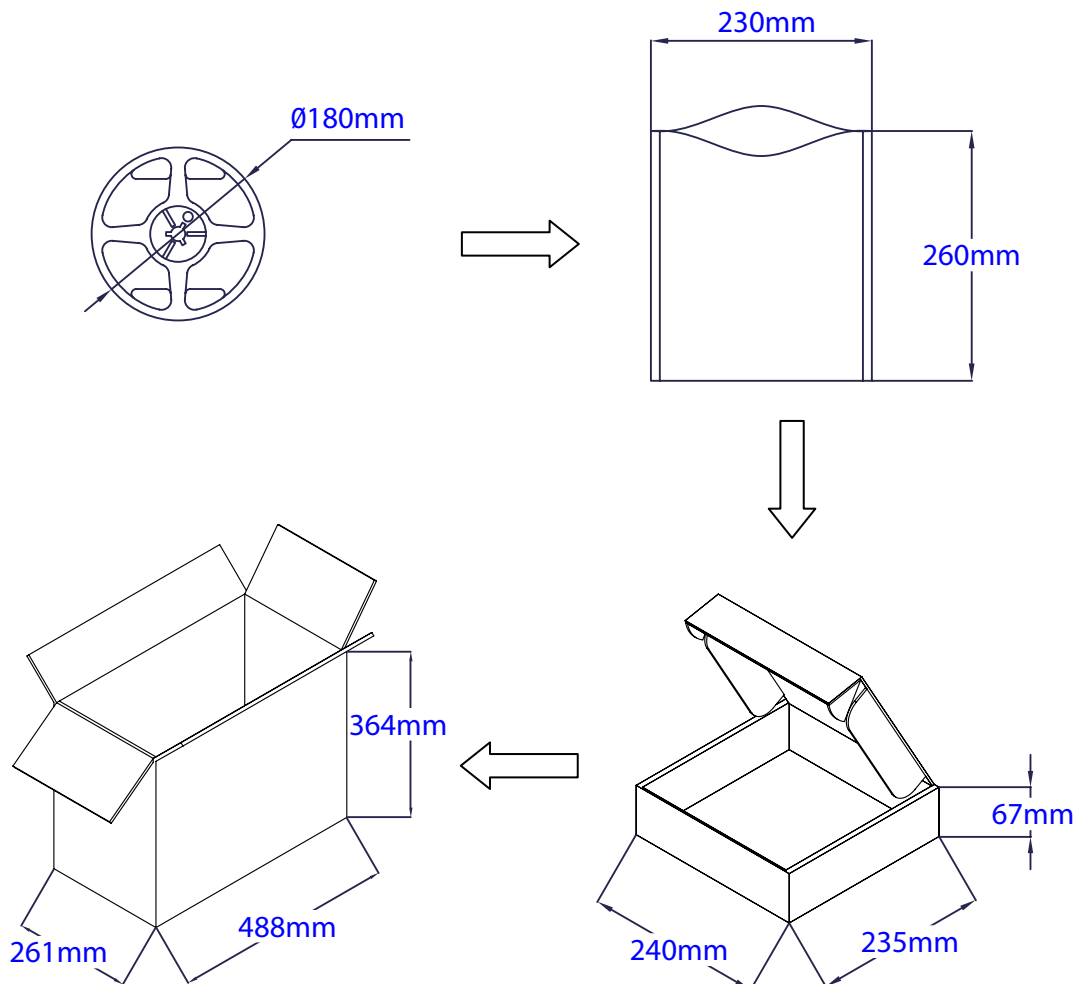

Environmental Compliance

PLCC Lightbar Waterproof FPC series are compliant to the Restriction of Hazardous Substances Directive or RoHS. The restricted materials including lead, mercury cadmium hexavalent chromium, polybrominated biphenyls (PBB) and polybrominated diphenyl ether (PBDE) are not used in PLCC lightbar FPC series to provide an environmentally friendly product to the customers.

Application Notes

PLCC Lightbar Waterproof series are available in Cool White, Neutral White and Warm White for application such as under-cabinet lighting, cove lighting and wall washing. Moreover, additional fine-tuned high color rendering index (CRI) version of Cool White, Neutral White and Warm White all make PLCC Lightbar the ideal lighting choice for vividly building or decoration products, presenting the products outline.

Revision History

Versions	Description	Release Date
1	Establish order code information	2014/01/10
2	Revise Waterproof Level	2014/01/23

About Edison Opto

Edison Opto is a leading manufacturer of high power LED and a solution provider experienced in LDMS. LDMS is an integrated program derived from the four essential technologies in LED lighting applications- Thermal Management, Electrical Scheme, Mechanical Refinement, Optical Optimization, to provide customer with various LED components and modules. More Information about the company and our products can be found at www.edison-opto.com

Copyright©2014 Edison Opto. All rights reserved. No part of publication may be reproduced or transmitted in any form or by any means, electronic or mechanical, including photo copy, recording or any other information storage and retrieval system, without prior permission in writing from the publisher. The information in this publication are subject to change without notice.

www.edison-opto.com

For general assistance please contact:
service@edison-opto.com.tw

For technical assistance please contact:
LED.Detective@edison-opto.com.tw