

ONE SIDE NO FEEDBACK

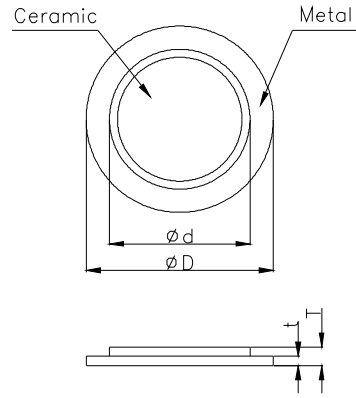

MODEL NO.	RESONANT FREQUENCY	RESONANT IMPEDANCE max.	CAPACITY $\pm 30\%$ pF	DIMENSIONS				PLATE MATERIAL
	KHz	Ω		D mm	d mm	T mm	t mm	
MZ-35260B00	2.6	300	30000	35.0	24.8	0.47	0.23	Brass