

SWITCH CIRCUIT			MATERIAL AND FINISH AS BELOW						
WHEN CARD IS EJECTED		WHEN CARD IS INSERTED		A	Housing	LCP UL94V-0 Black	E		
				B	Contact	Phosphor Bronze C5210, Contact Area: Gold Flash	F		
				C	Latch	Stainless Steel SUS301	G		
				D			H		

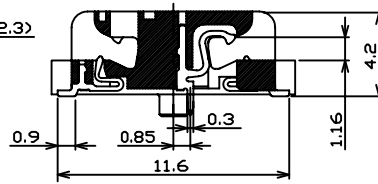
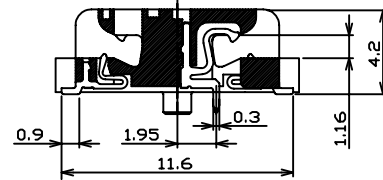
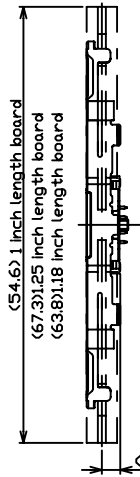
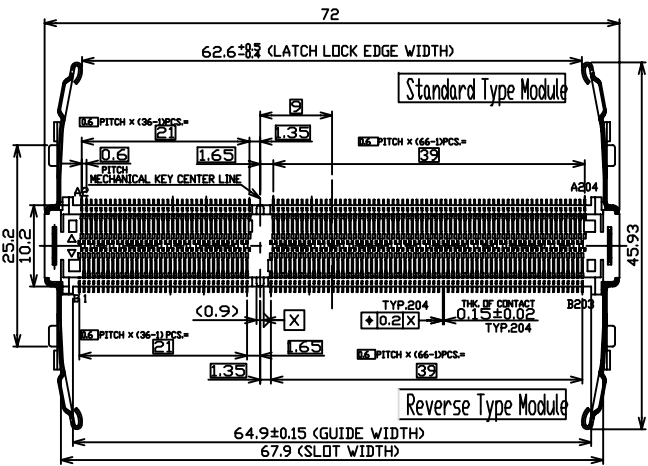

SPECIFICATION:

1. ELECTRICAL

- 1.1 Current Rating: 0.3A per pin
- 1.2 Voltage Rating: 25V AC/DC
- 1.3 Contact Resistance: 60mΩ
- 1.4 Insulation Resistance: 250MΩ
- 1.5 Dielectric Withstanding Voltage: 125VAC

2. MECHANICAL

- 2.1 Durability: 25 Cycle
- 2.2 Mating Force: 78.4N Max

3. ENVIRONMENTAL

- 3.1 Operating temperature range: -40°C~+85°C
- 3.2 Storage temperature range: -40°C~+85°C

4. SOLDER ABILITY

- 4.1 Recommended IR Reflow Temperature: 255°C 10Sec

P1	P2	P3	P4	P5	P6	P7	P8	P9	P10	P11	P12
----	----	----	----	----	----	----	----	----	-----	-----	-----

PIN ASSIGNMENT

122C-42A00	SO DIMM DDR3 Socket Dual Card Type 1.5V 204Pin 4.2H, Contact Area: Gold Flash
------------	---

PRODUCT NO.	DESCRIPTION
-------------	-------------

UNLESS OTHERWISE SPECIFIED TOLERANCE		
ANGLES	ANG.	±5°
LINEAR	0.	±0.3
	0.0	±0.25
	0.00	±0.20
SCALE	AS SHOWN	UNIT: mm
DRAWN	Willis	2012/12/05
CHECKED	Angel	2012/12/05
APPROVED	Ken	2012/12/05



www.attend.com.tw

DRAWN NAME: SO DIMM DDR3 Socket Dual Card Type 1.5V 204Pin 4.2H

PRODUCT NO. 122C-42A00

REV.	DESCRIPTION	DATE	REV.	DESCRIPTION	DATE
1			1		
2			2		
3			3		
4			4		
5			5		
6			6		
7			7		

- △ Revise:
- △ Revise:
- △ Revise:

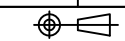

SIZE A4

REV. 1.0

FILE NAME 122C-42A00_B_1

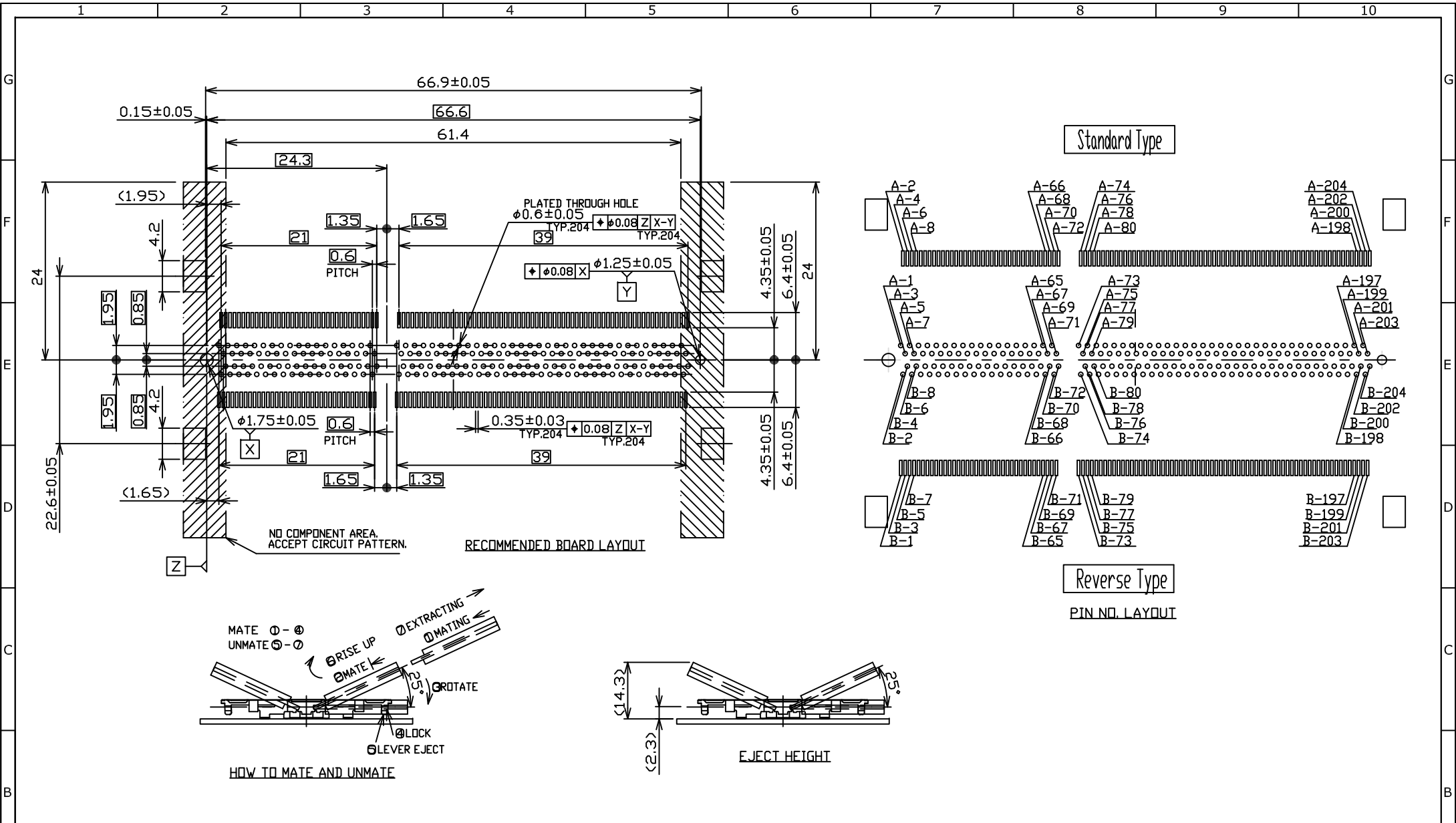

REV.	DESCRIPTION	DATE	REV.	DESCRIPTION	DATE	SIZE	REV.	FILE NAME
1			1			A4	1.0	122C-42A00_B_1

UNLESS OTHERWISE SPECIFIED TOLERANCE		
ANGLES	ANG.	±5°
LINEAR	0.	±0.3
	0.0	±0.25
	0.00	±0.20
SCALE	AS SHOWN	UNIT: mm

A Revise: Revise: Revise:	DRAWN: Willis CHECKED: Angel APPROVED: Ken	2012/12/05 2012/12/05 2012/12/05	www.attend.com.tw DRAWN NAME: SO DIMM DDR3 Socket Dual Card Type 1.5V 204Pin 4.2H
PRODUCT NO. 122C-42A00 FILE NAME 122C-42A00_B_1			

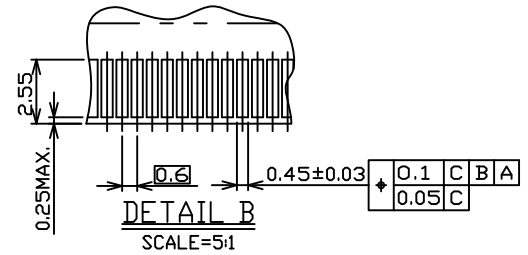
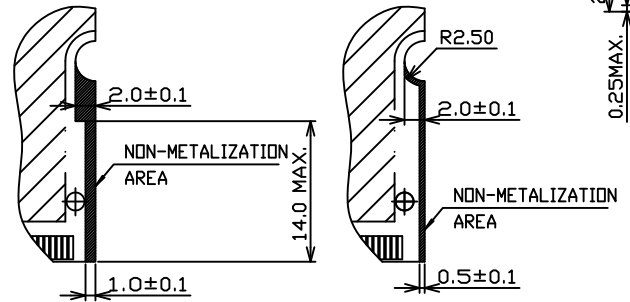
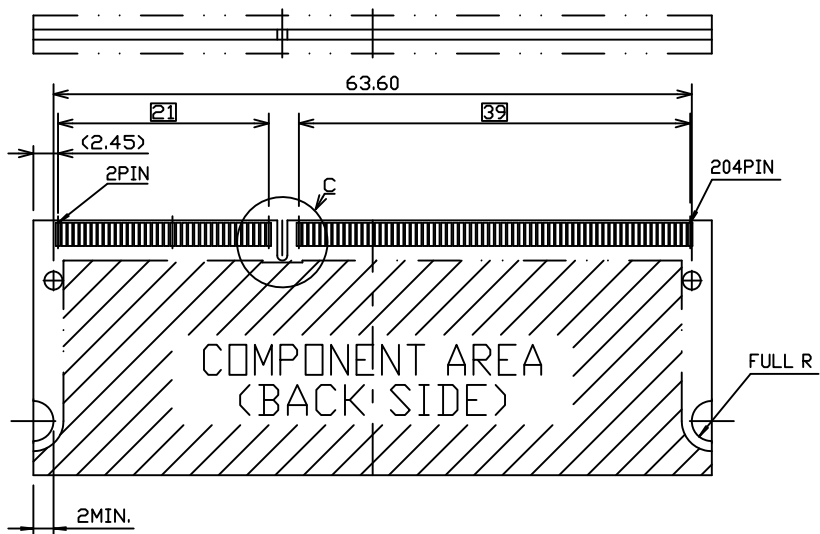
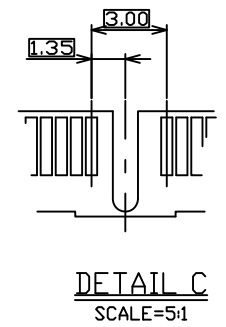
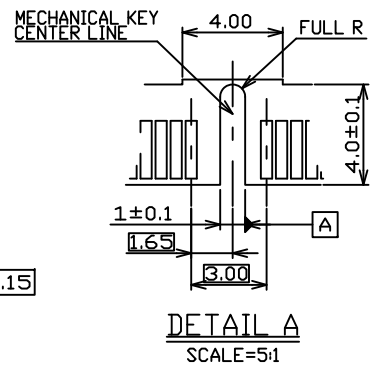
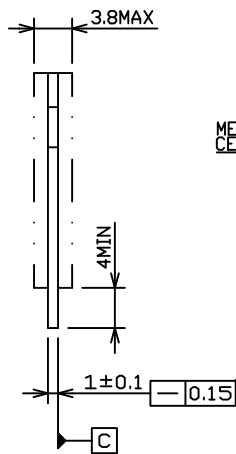
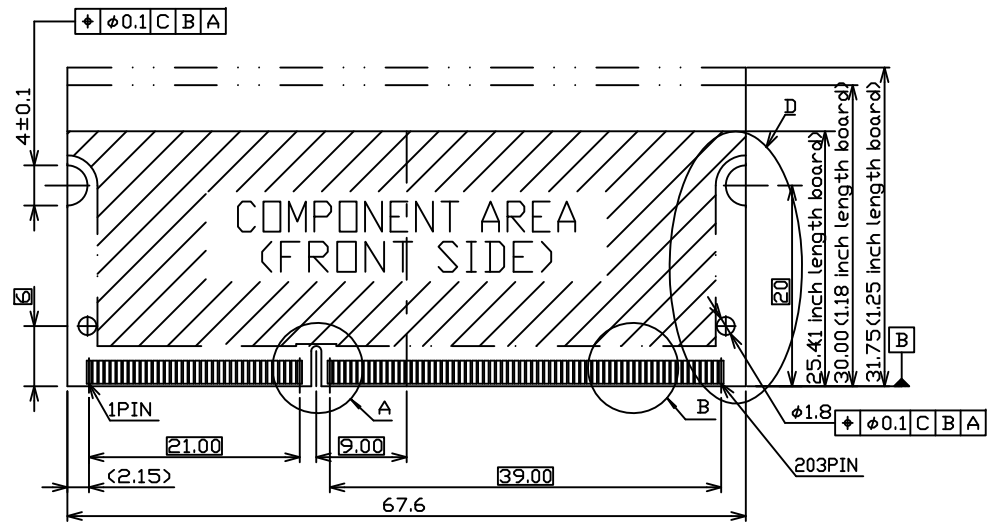

RECOMMENDED MATING
P.C. BOARD DIM.

REV.	DESCRIPTION	DATE	REV.	DESCRIPTION	DATE	SIZE	REV.	FILE NAME
1			4			A4	1.0	122C-42A00_B_1

UNLESS OTHERWISE SPECIFIED TOLERANCE		
ANGLES	ANG.	±5°
LINEAR	0.	±0.3
	0.0	±0.25
	0.00	±0.20
SCALE	AS SHOWN	UNIT: mm
DRAWN	Willis	2012/12/05
CHECKED	Angel	2012/12/05
APPROVED	Ken	2012/12/05

www.attend.com.tw	
DRAWN NAME: SO DIMM DDR3 Socket	
Dual Card Type 1.5V 204Pin 4.2H	
PRODUCT NO.	122C-42A00



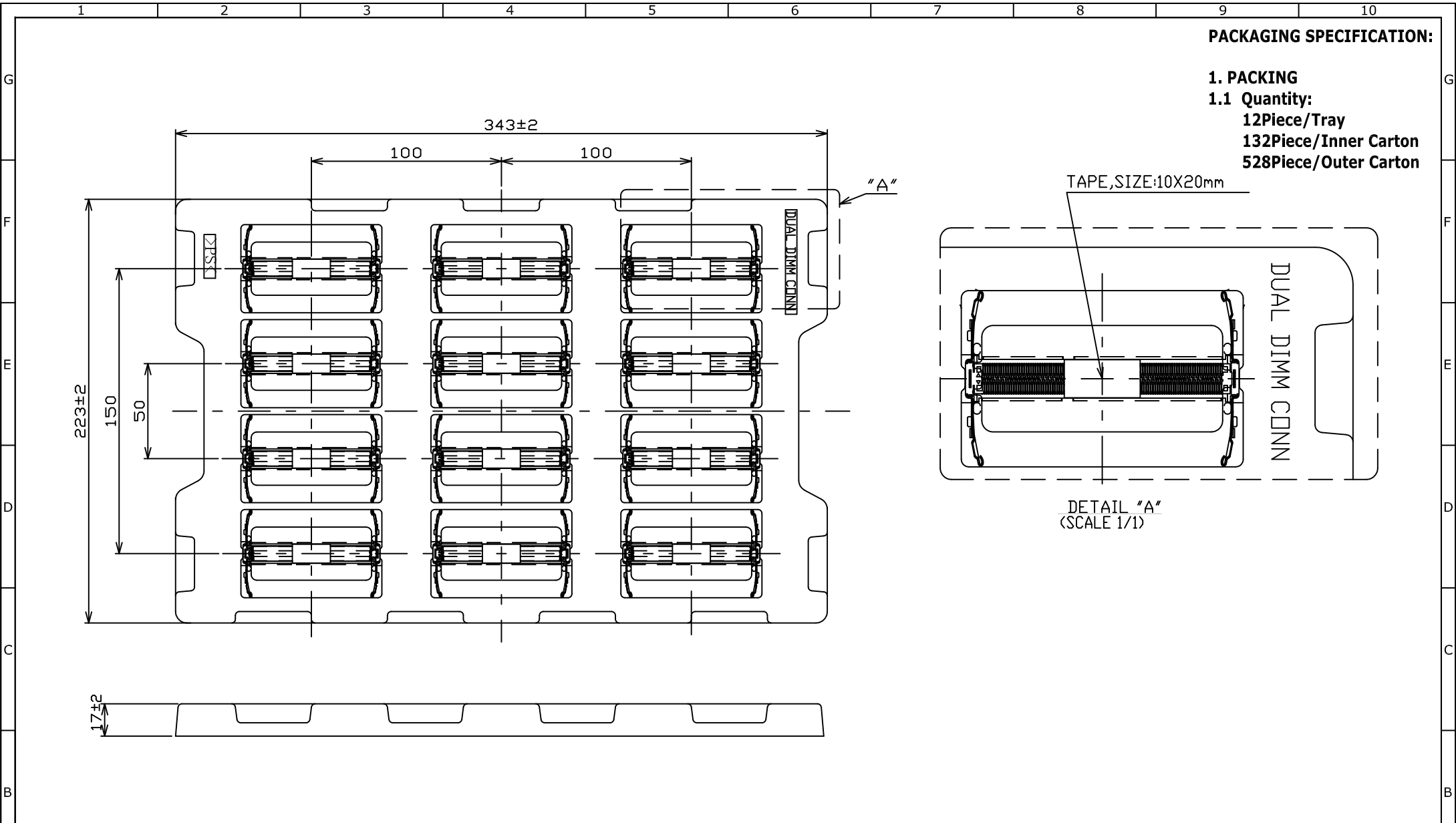

PACKAGING SPECIFICATION:

1. PACKING
1.1 Quantity:
12Piece/Tray
132Piece/Inner Carton
528Piece/Outer Carton

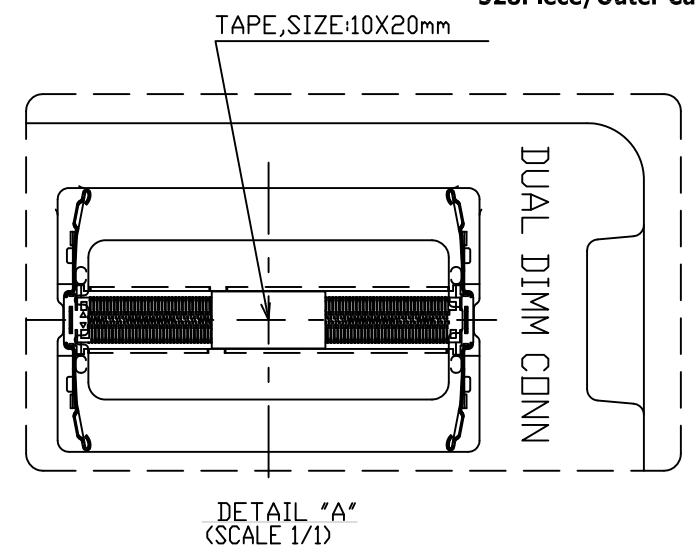

						UNLESS OTHERWISE SPECIFIED TOLERANCE			 www.attend.com.tw	
						ANGLES	ANG.	±5°		
						LINEAR	0.	±0.3		
							0.00	±0.25		
						SCALE	AS SHOWN	UNIT: mm	±0.20	
						DRAWN	Willis	2012/12/05	DRAWN NAME: SO DIMM DDR3 Socket	
						CHECKED	Angel	2012/12/05	Dual Card Type 1.5V 204Pin 4.2H	
						APPROVED	Ken	2012/12/05	PRODUCT NO.	122C-42A00
REV.	DESCRIPTION		DATE	REV.	DESCRIPTION		DATE	SIZE	REV.	FILE NAME
1				4				A4	1.0	122C-42A00_D_1

A
 △ Revise:
 △ Revise:
 △ Revise:

A