

# N-CHANNEL ENHANCEMENT MODE VERTICAL DMOS FET

## ZVNL120A

ISSUE 2 – MARCH 94

### FEATURES

- \* 200 Volt  $V_{DS}$
- \*  $R_{DS(on)}=10\Omega$
- \* Low threshold

### APPLICATIONS

- \* Telephone handsets

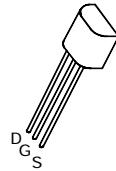

E-Line  
TO92 Compatible

### ABSOLUTE MAXIMUM RATINGS.

PARAMETER	SYMBOL	VALUE	UNIT
Drain-Source Voltage	$V_{DS}$	200	V
Continuous Drain Current at $T_{amb}=25^{\circ}C$	$I_D$	180	mA
Pulsed Drain Current	$I_{DM}$	2	A
Gate Source Voltage	$V_{GS}$	$\pm 20$	V
Power Dissipation at $T_{amb}=25^{\circ}C$	$P_{tot}$	700	mW
Operating and Storage Temperature Range	$T_j; T_{stg}$	-55 to +150	$^{\circ}C$

### ELECTRICAL CHARACTERISTICS (at $T_{amb} = 25^{\circ}C$ unless otherwise stated).

PARAMETER	SYMBOL	MIN.	MAX.	UNIT	CONDITIONS.
Drain-Source Breakdown Voltage	$BV_{DSS}$	200		V	$I_D=1mA, V_{GS}=0V$
Gate-Source Threshold Voltage	$V_{GS(th)}$	0.5	1.5	V	$I_D=1mA, V_{DS}=V_{GS}$
Gate-Body Leakage	$I_{GSS}$		100	nA	$V_{GS}=\pm 20V, V_{DS}=0V$
Zero Gate Voltage Drain Current	$I_{DSS}$		10 100	$\mu A$ $\mu A$	$V_{DS}=200V, V_{GS}=0$ $V_{DS}=160V, V_{GS}=0V, T=125^{\circ}C(2)$
On-State Drain Current(1)	$I_{D(on)}$	500		mA	$V_{DS}=25V, V_{GS}=5V$
Static Drain-Source On-State Resistance (1)	$R_{DS(on)}$		10 10	$\Omega$ $\Omega$	$V_{GS}=5V, I_D=250mA$ $V_{GS}=3V, I_D=125mA$
Forward Transconductance (1)(2)	$g_{fs}$	200		mS	$V_{DS}=25V, I_D=250mA$
Input Capacitance (2)	$C_{iss}$		85	pF	$V_{DS}=25V, V_{GS}=0V, f=1MHz$
Common Source Output Capacitance (2)	$C_{oss}$		20	pF	
Reverse Transfer Capacitance (2)	$C_{rss}$		7	pF	
Turn-On Delay Time (2)(3)	$t_{d(on)}$		8	ns	$V_{DD}=25V, I_D=250mA$
Rise Time (2)(3)	$t_r$		8	ns	
Turn-Off Delay Time (2)(3)	$t_{d(off)}$		20	ns	
Fall Time (2)(3)	$t_f$		12	ns	

(1) Measured under pulsed conditions. Width=300 $\mu s$ . Duty cycle  $\leq 2\%$  (2) Sample test.

(3) Switching times measured with 50 $\Omega$  source impedance and <5ns rise time on a pulse generator

# ZVNL120A

## TYPICAL CHARACTERISTICS

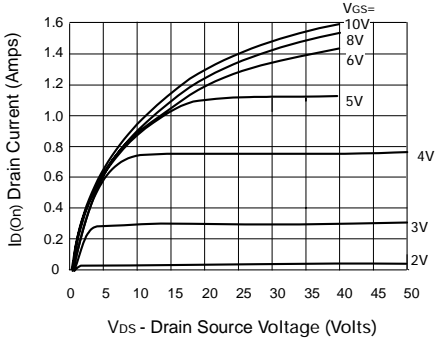

**Output Characteristics**

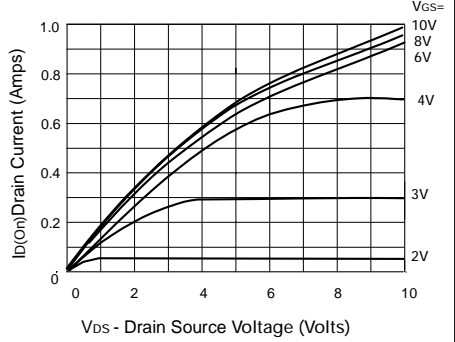

**Saturation Characteristics**

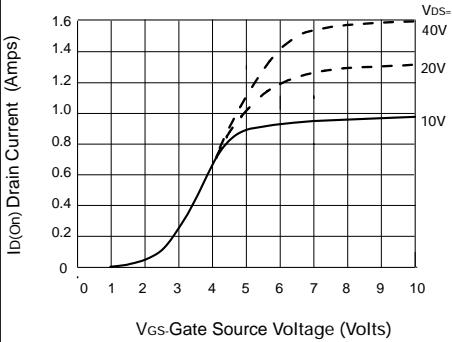

**Transfer Characteristics**

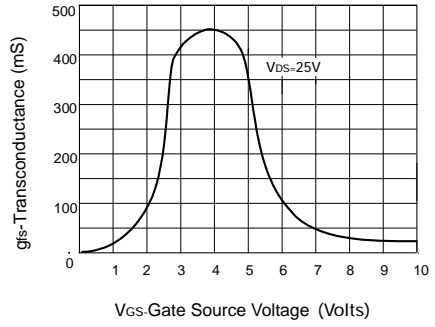

**Transconductance v gate-source voltage**

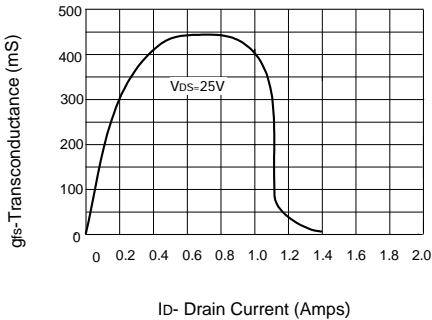

**Transconductance v drain current**

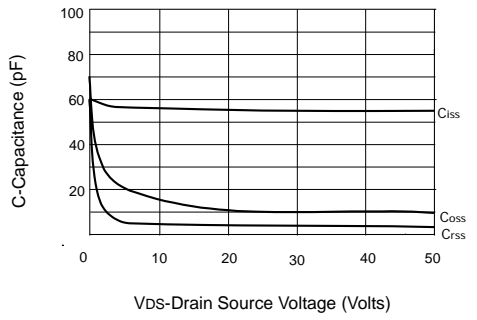

**Capacitance v drain-source voltage**

## TYPICAL CHARACTERISTICS

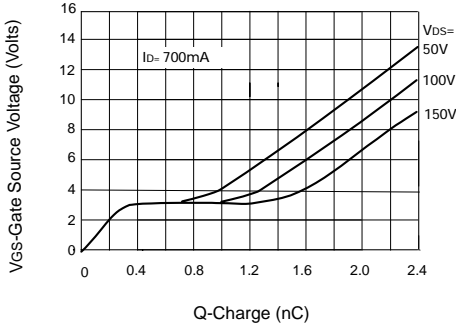

**Gate charge v gate-source voltage**

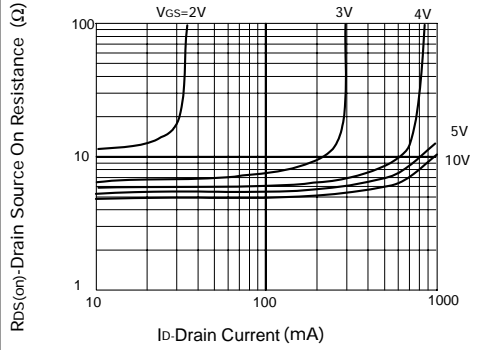

**On-resistance v drain current**

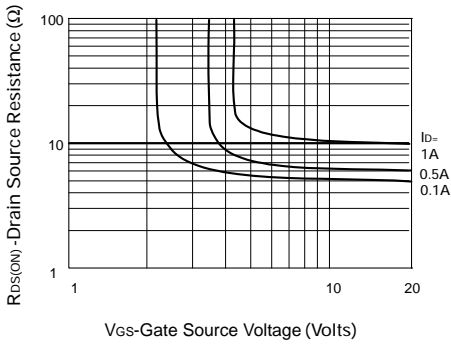

**On-resistance vs gate-source voltage**

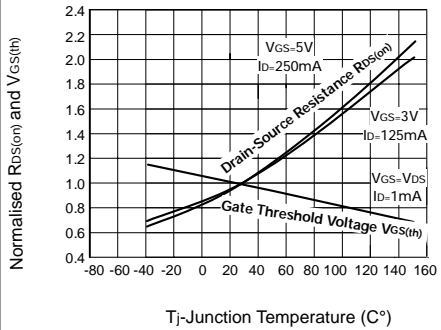

**Normalised  $R_{DS(on)}$  and  $V_{GS(th)}$  vs Temperature**