

## LOW POWER, BANDGAP VOLTAGE REFERENCES

### FEATURES

- Output Tolerance ..... 1% or 2%
- Output Voltage Option
  - LM285/385-1.2V ..... 1.235V
  - LM285/385-2.5V ..... 2.5V
- Wide Operating Current Range
  - LM285/385-1.2V ..... 15µA to 20mA
  - LM285/385-2.5V ..... 20µA to 20mA
- Temperature Coefficient ..... 30ppm/°C
- Dynamic Impedance ..... 0.6Ω
- TO-92-3 Plastic Package
- 8-Pin Plastic Narrow Body (SOIC) Package

### APPLICATIONS

- ADC and DAC Reference
- Current Source Generation
- Threshold Detectors
- Power Supplies
- Multi-meters

### GENERAL DESCRIPTION

The LM285/385-1.2V (1.235V output) and LM285/385-2.5V (2.5V output) are bipolar, two-terminal, bandgap voltage references that offer precision performance without premium price. These devices do not require thin-film resistors, greatly lowering manufacturing complexity and cost.

A 30ppm/°C output temperature coefficient and a 15µA to 20mA operating current range make these voltage references especially attractive for multimeter, data acquisition and telecommunications applications.

### PIN CONFIGURATIONS

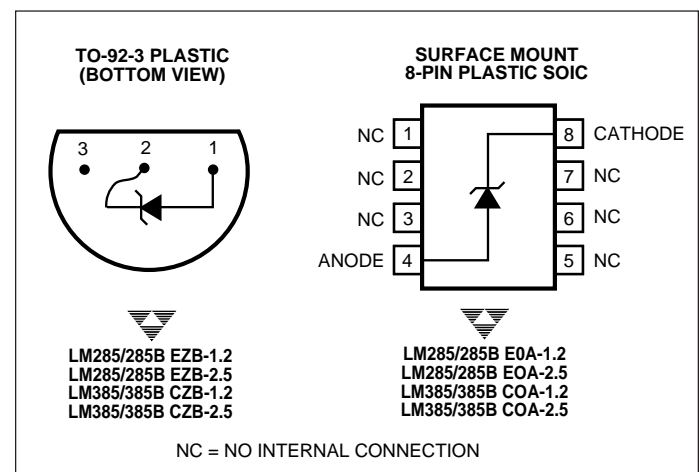

### ORDERING INFORMATION

Part No.	Package	Temperature Range	Voltage	Tolerance
LM285BEOA-1.2	8-Pin SOIC	-40°C to +85°C	1.2	1%
LM285BEOA-2.5	8-Pin SOIC	-40°C to +85°C	2.5	1.5%
LM285BEZB-1.2	TO-92-3	-40°C to +85°C	1.2	1%
LM285BEZB-2.5	TO-92-3	-40°C to +85°C	2.5	1.5%
LM285EOA-1.2	8-Pin SOIC	-40°C to +85°C	1.2	2%
LM285EOA-2.5	8-Pin SOIC	-40°C to +85°C	2.5	3%
LM285EZB-1.2	TO-92-3	-40°C to +85°C	1.2	2%
LM285EZB-2.5	TO-92-3	-40°C to +85°C	2.5	3%
LM385BCOA-1.2	8-Pin SOIC	0°C to +70°C	1.2	1%
LM385BCOA-2.5	8-Pin SOIC	0°C to +70°C	2.5	1.5%
LM385BCZB-1.2	TO-92-3	0°C to +70°C	1.2	1%
LM385BCZB-2.5	TO-92-3	0°C to +70°C	2.5	1.5%
LM385COA-1.2	8-Pin SOIC	0°C to +70°C	1.2	2%
LM385COA-2.5	8-Pin SOIC	0°C to +70°C	2.5	3%
LM385CZB-1.2	TO-92-3	0°C to +70°C	1.2	2%
LM385CZB-2.5	TO-92-3	0°C to +70°C	2.5	3%

# LOW POWER, BANDGAP VOLTAGE REFERENCES

## LM285/285B-1.2V LM285/285B-2.5V LM385/385B-1.2V LM385/385B-2.5V

### ABSOLUTE MAXIMUM RATINGS\*

Forward Current .....	+10mA
Reverse Current .....	+30mA
Storage Temperature Range .....	- 65°C to +150°C
Operating Temperature Range	
TO-92 Package .....	- 40°C to +85°C
Surface Mount Package .....	- 40°C to +85°C

Lead Temperature (Soldering, 10 sec)	
TO-92 Package .....	+300°C
Surface Mount Package .....	+300°C
Power Dissipation	
Limited by Forward/Reverse Current	

\*Functional operation above the absolute maximum stress ratings is not implied.

### ELECTRICAL CHARACTERISTICS: T<sub>A</sub> = +25°C, unless otherwise specified.

Symbol	Parameter	Test Conditions	LM285 / LM285B-1.2			LM385 / LM385B-1.2			Unit
			Min	Typ	Max	Min	Typ	Max	
V <sub>(BR)R</sub>	Reverse Breakdown Voltage LM285B-1.2/LM385B-1.2 T <sub>A</sub> = T <sub>low</sub> to T <sub>high</sub> (Note 1) LM285-1.2V/LM385-1.2V T <sub>A</sub> = T <sub>low</sub> to T <sub>high</sub> (Note 1)	I <sub>R</sub> ≤ 20mA	1.223	1.235	1.247	1.223	1.235	1.247	V
			1.200	—	1.270	1.210	—	1.260	
			1.205	1.235	1.260	1.205	1.235	1.260	
			1.192	—	1.273	1.192	—	1.273	
I <sub>RMIN</sub>	Minimum Operating Current T <sub>A</sub> = +25°C T <sub>A</sub> = T <sub>low</sub> to T <sub>high</sub> (Note 1)		—	8.0	15	—	8.0	15	µA
			—	—	20	—	—	20	
ΔV <sub>(BR)R</sub>	Reverse Breakdown Voltage Change with Current I <sub>Rmin</sub> = I <sub>R</sub> = 1.0mA, T <sub>A</sub> = +25°C T <sub>A</sub> = T <sub>low</sub> to T <sub>high</sub> (Note 1) 1.0mA = I <sub>R</sub> = 20mA, T <sub>A</sub> = +25°C T <sub>A</sub> = T <sub>low</sub> to T <sub>high</sub> (Note 1)		—	—	1.0	—	—	1.0	mV
			—	—	1.5	—	—	1.5	
			—	—	10	—	—	20	
			—	—	20	—	—	25	
Z	Reverse Dynamic Impedance	I <sub>R</sub> = 100µA	—	0.6	—	—	0.6	—	Ω
ΔV <sub>(BR)/ΔT</sub>	Average Temperature Coefficient	10µA ≤ I <sub>R</sub> ≤ 20mA	—	30	100	—	30	100	ppm/°C
S	Long Term Stability	I <sub>R</sub> = 100µA, T <sub>A</sub> = +25°C ±0.1°C	—	20	—	—	20	—	ppm/kHR

Symbol	Parameter	Test Conditions	LM285 / LM285B-2.5			LM385 / LM385B-2.5			Unit
			Min	Typ	Max	Min	Typ	Max	
V <sub>(BR)R</sub>	Reverse Breakdown Voltage LM285B-2.5/LM385B-2.5 T <sub>A</sub> = T <sub>low</sub> to T <sub>high</sub> (Note 1) LM285-2.5V/LM385-2.5V T <sub>A</sub> = T <sub>low</sub> to T <sub>high</sub> (Note 1)	I <sub>R</sub> = 20mA	2.462	2.5	2.538	2.462	2.5	2.538	V
			2.415	—	2.585	2.436	—	2.564	
			2.425	2.5	2.575	2.425	2.5	2.575	
			2.400	—	2.600	2.400	—	2.600	
I <sub>RMIN</sub>	Minimum Operating Current T <sub>A</sub> = +25°C T <sub>A</sub> = T <sub>low</sub> to T <sub>high</sub> (Note 1)		—	13	20	—	13	20	µA
			—	—	30	—	—	30	
ΔV <sub>(BR)R</sub>	Reverse Breakdown Voltage Change with Current I <sub>Rmin</sub> = I <sub>R</sub> = 1.0mA, T <sub>A</sub> = +25°C T <sub>A</sub> = T <sub>low</sub> to T <sub>high</sub> (Note 1) 1.0mA = I <sub>R</sub> = 20mA, T <sub>A</sub> = +25°C T <sub>A</sub> = T <sub>low</sub> to T <sub>high</sub> (Note 1)		—	—	1.0	—	—	2.0	mV
			—	—	1.5	—	—	2.5	
			—	—	10	—	—	20	
			—	—	20	—	—	25	
Z	Reverse Dynamic Impedance	I <sub>R</sub> = 100µA	—	0.6	—	—	0.6	—	Ω
ΔV <sub>(BR)/ΔT</sub>	Average Temperature Coefficient	20µA ≤ I <sub>R</sub> ≤ 20mA	—	30	100	—	30	100	ppm/°C
S	Long Term Stability	I <sub>R</sub> = 100µA, T <sub>A</sub> = +25°C ±0.1°C	—	20	—	—	20	—	ppm/kHR

Note: 1. T<sub>low</sub> = - 40°C for LM285-1.2, LM285-2.5, LM285B-1.2, LM285B-2.5  
0°C for LM385-1.2, LM385B-1.2, LM385-2.5, LM385B-2.5  
T<sub>high</sub> = +85°C for LM285-1.2, LM285-2.5, LM285B-1.2, LM285B-2.5  
+70°C for LM385-1.2, LM385B-1.2, LM385-2.5, LM385B-2.5

# LOW POWER, BANDGAP VOLTAGE REFERENCES

LM285/285B-1.2V  
 LM285/285B-2.5V  
 LM385/385B-1.2V  
 LM385/385B-2.5V

## TYPICAL APPLICATIONS

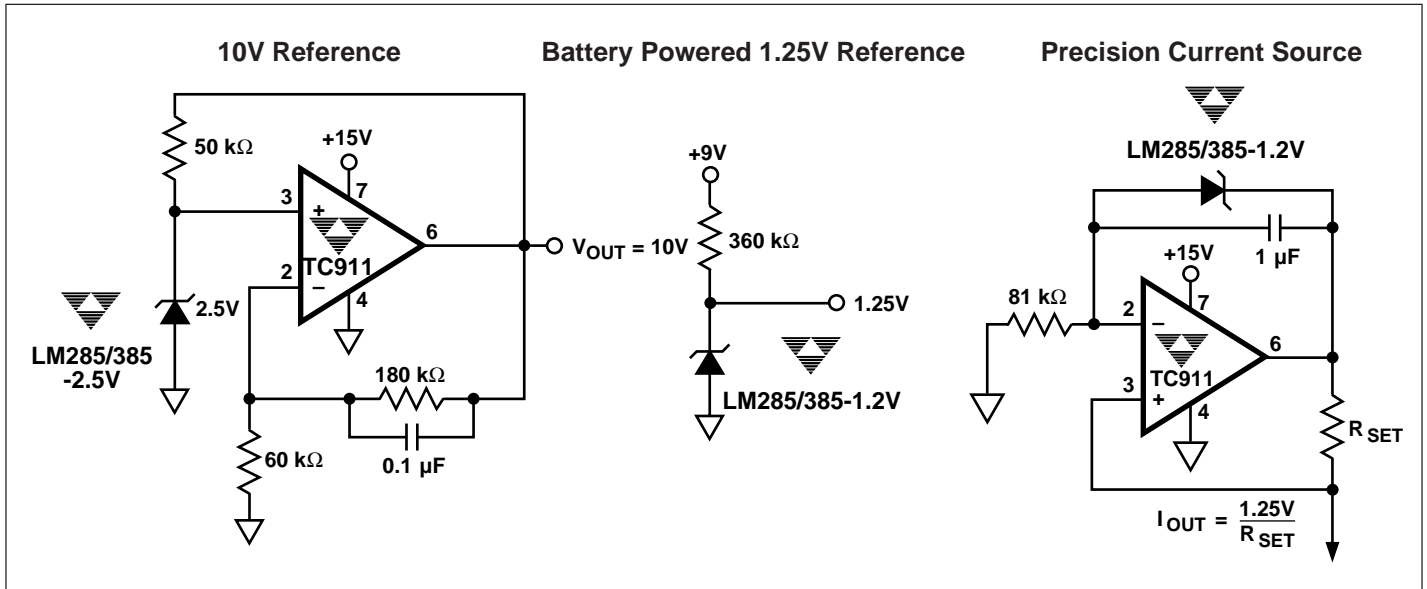

3

## RESPONSE TIME TEST CIRCUIT

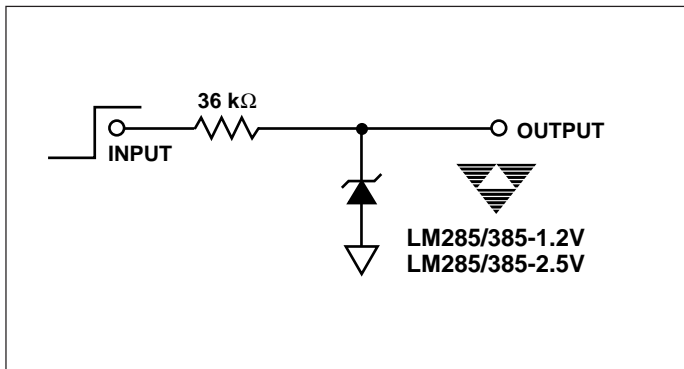

TYPICAL CHARACTERISTICS

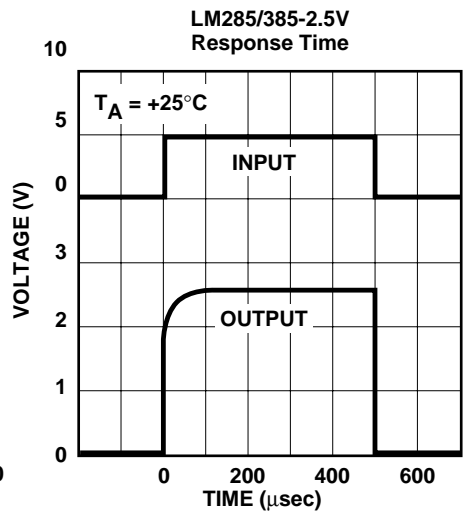
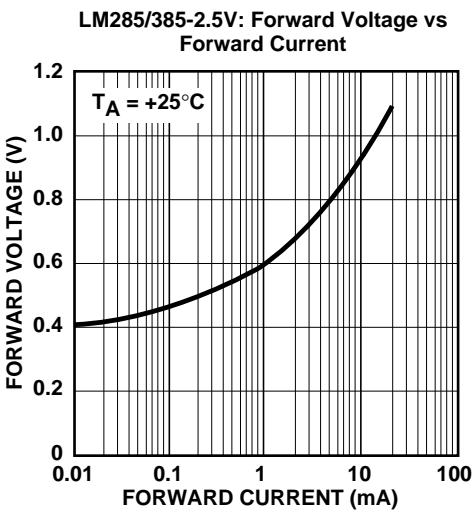
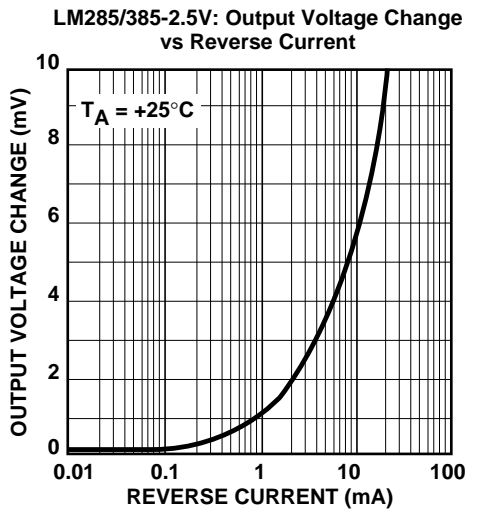
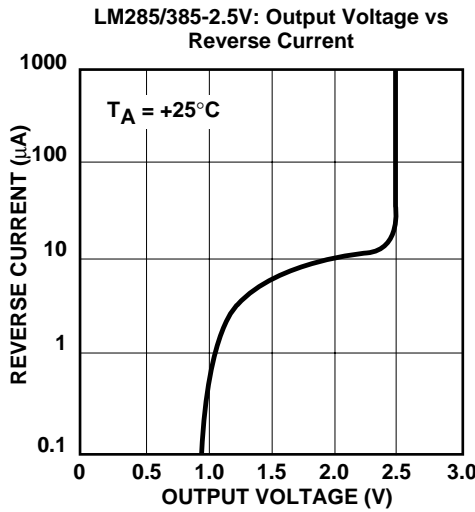
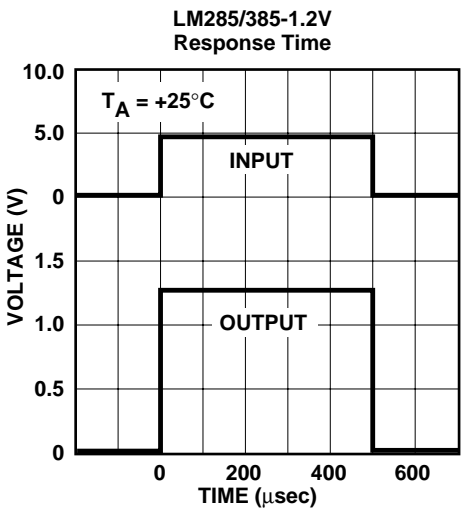
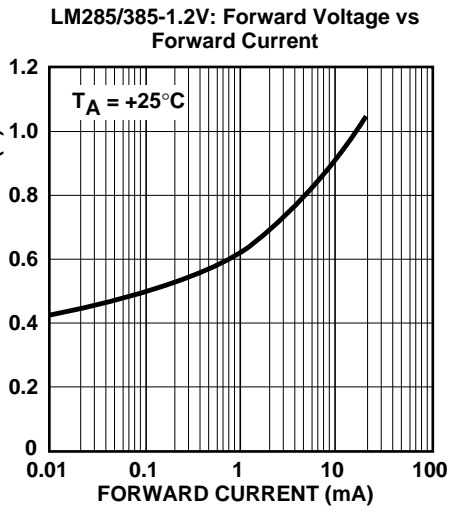
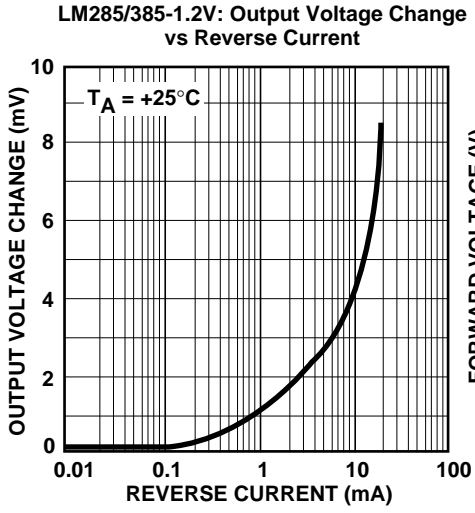
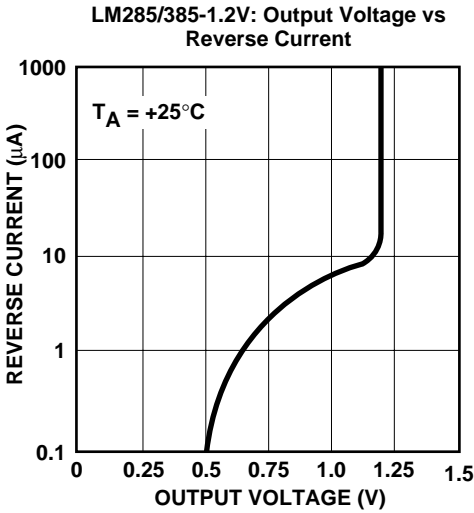

This datasheet has been downloaded from:

[www.DatasheetCatalog.com](http://www.DatasheetCatalog.com)

Datasheets for electronic components.